

TOP VIEW CBGA WITH BALL

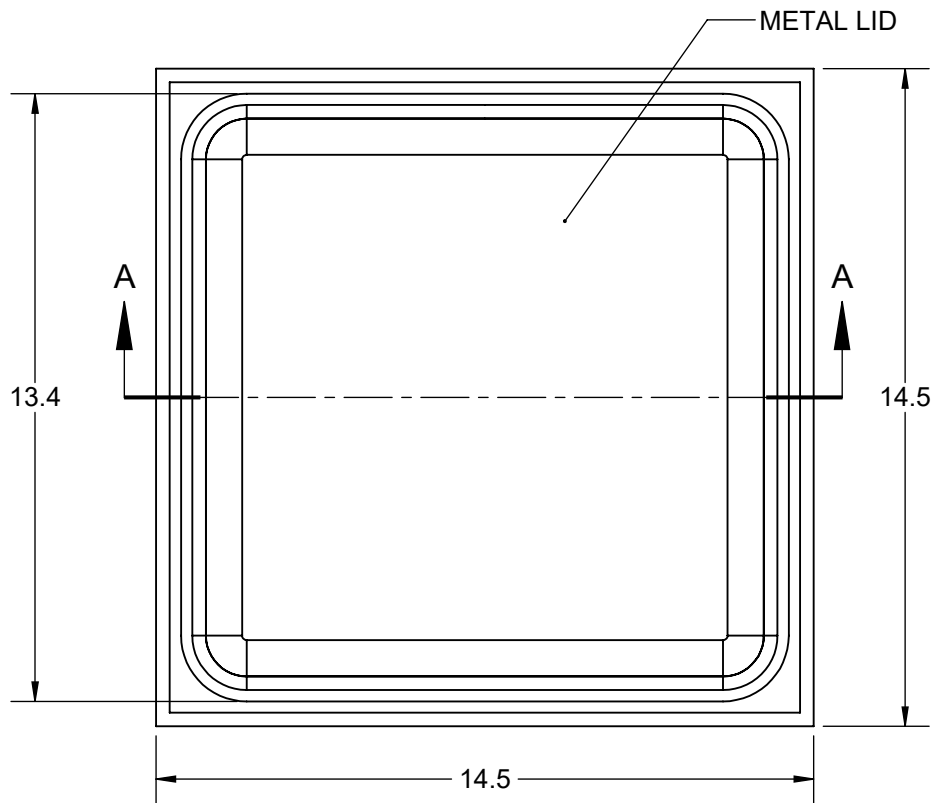

BALL VIEW

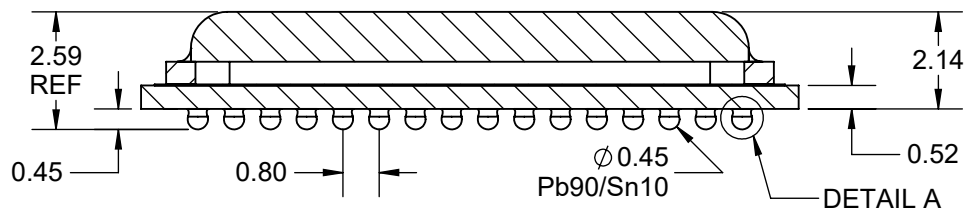
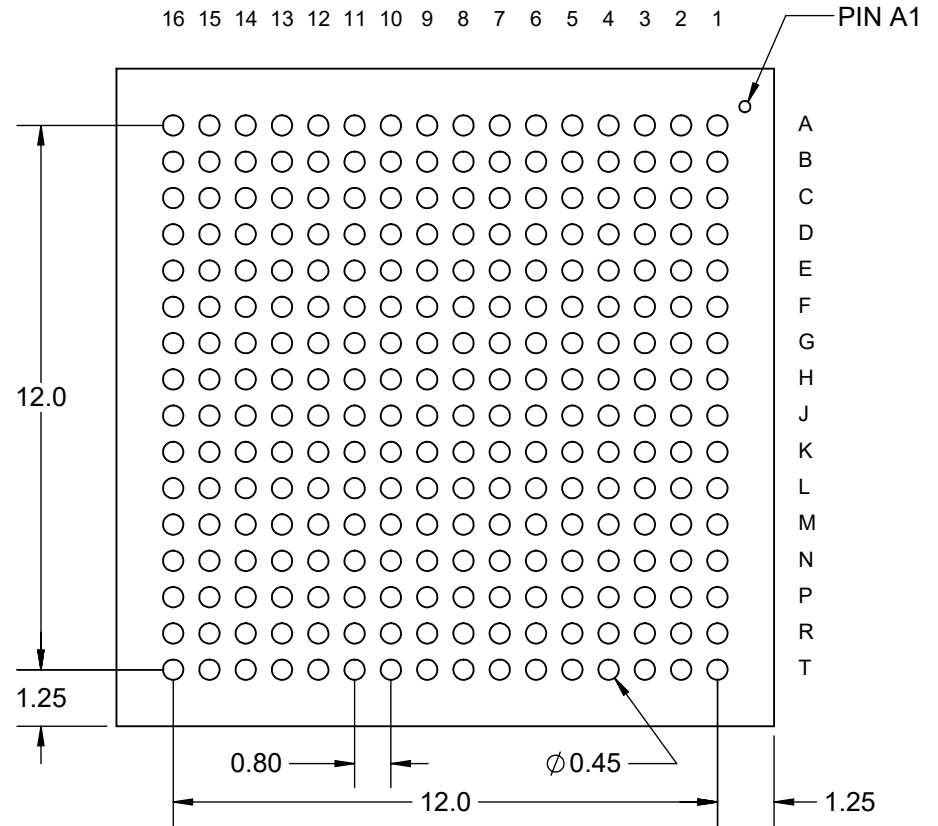

SECTION A-A
SCALE 6 : 1

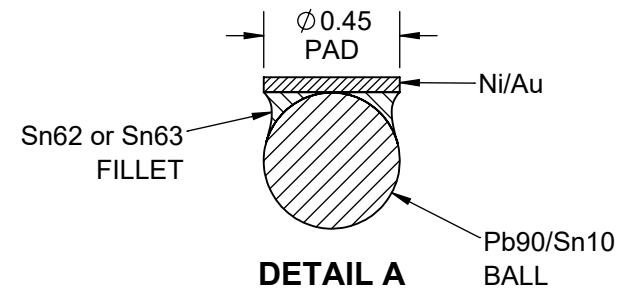

Notes: (Unless Otherwise Specified).

- 1) ALL DIMENSIONS ARE IN MM.
- 2) SOLDER BALL ALLOY: Pb90/Sn10.
- 3) BALL DIAMETER (BEFORE REFLOW) 0.457mm (18 MIL).
- 4) PAD Ni/Au DIAMETER: 0.45mm (17.7 MIL).
- 5) SUBSTRATE ALUMINA CERAMIC.

APPROVALS		DATE				
DRAWN	T. Au	7/22/2020				
ENG	M. Hart	7/22/2020	SCALE	SIZE	DRAWING NO.	REV
MFG			6:1	A	581696	A
QA			DO NOT SCALE DRAWING			SHEET 1 OF 5
CUST						
REVISED						

TOP VIEW

CLGA WITHOUT BALL

BALL VIEW

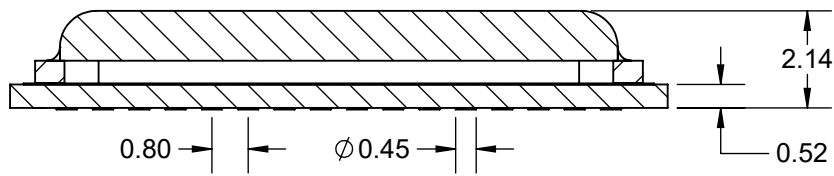
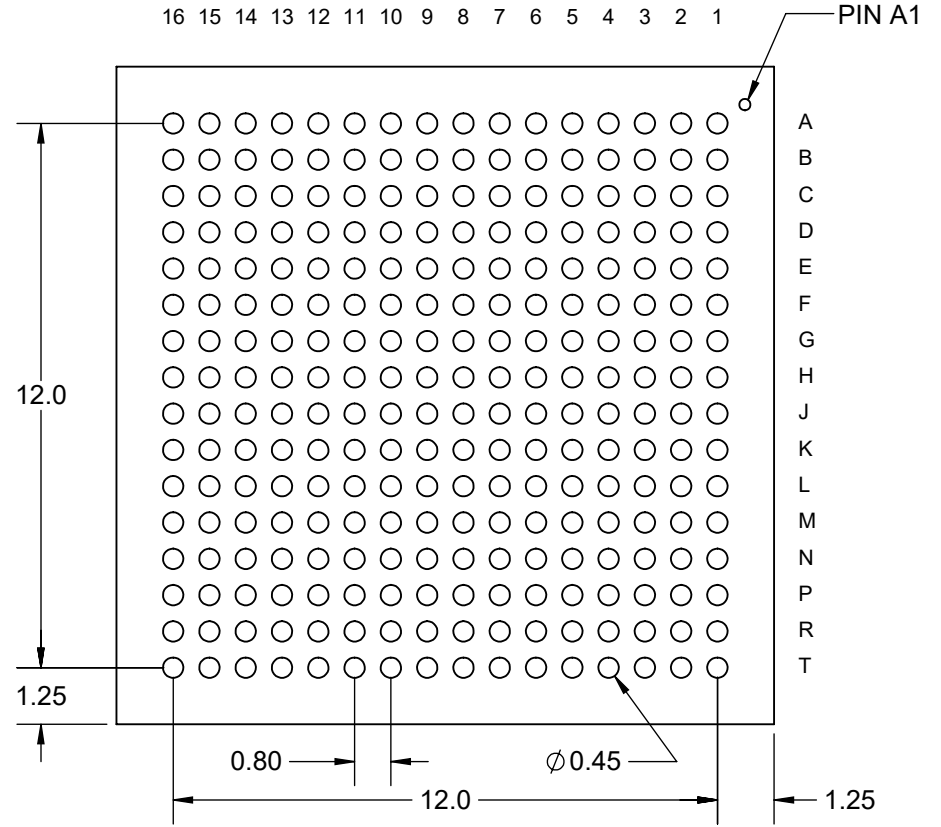
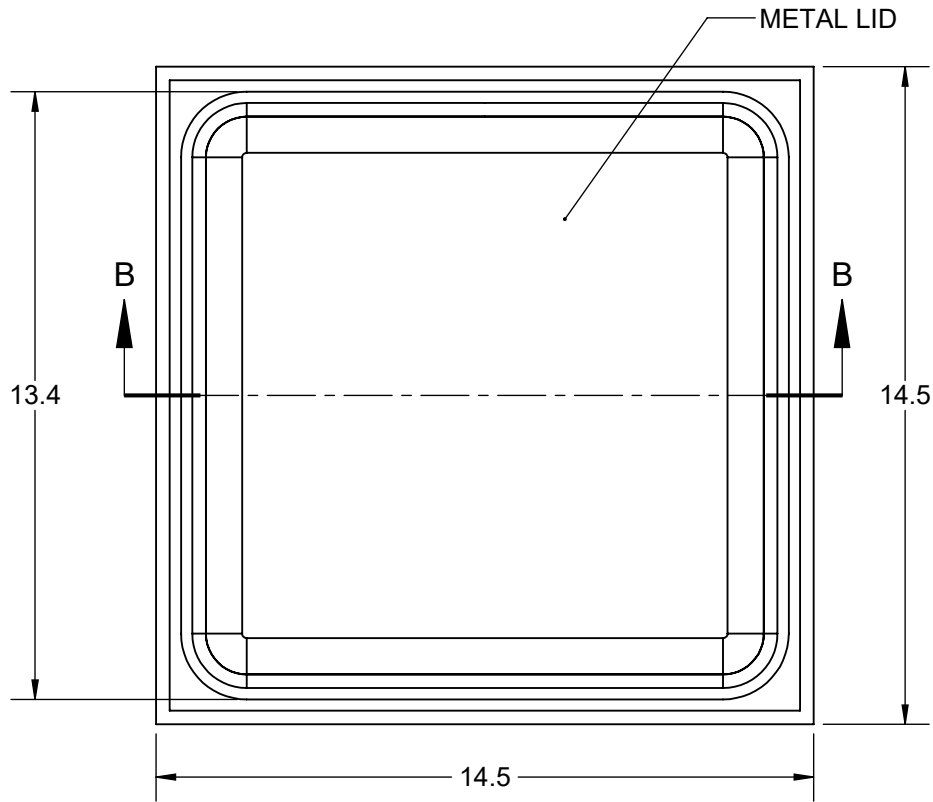

**SECTION B-B
SCALE 6 : 1**

Notes: (Unless Otherwise Specified).

- 1) ALL DIMENSIONS ARE IN MM.
- 2) SOLDER BALL ALLOY: NONE.
- 3) BALL DIAMETER (BEFORE REFLOW) NONE.
- 4) PAD Ni/Au DIAMETER: 0.45mm (17.7 MIL).
- 5) SUBSTRATE ALUMINA CERAMIC.

TopLine[®]			
TITLE CBGA256T.8-16x16 CERAMIC BALL GRID ARRAY			
SCALE	SIZE	DRAWING NO.	REV
6:1	A	581696	A
DO NOT SCALE DRAWING			SHEET 2 OF 5

BALL VIEW

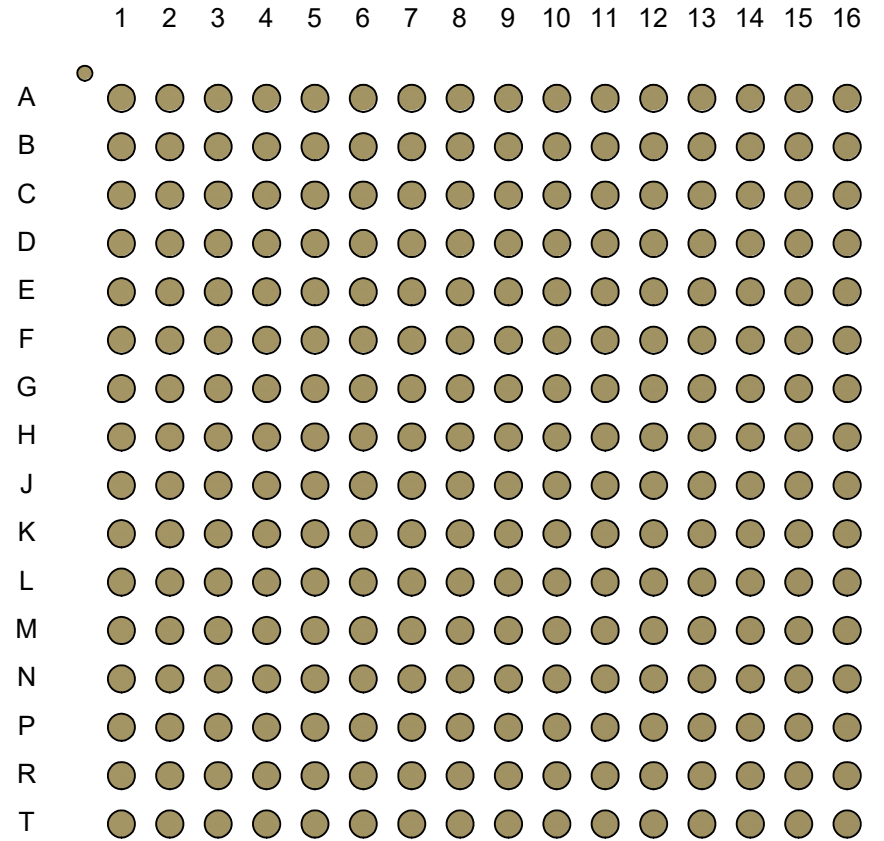
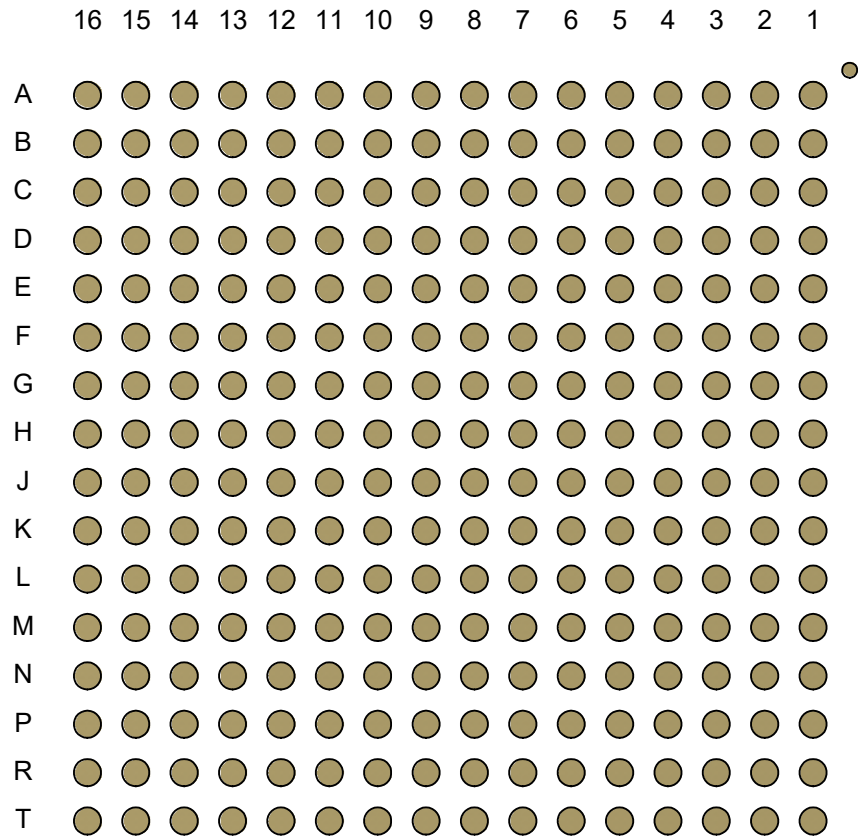

TopLine[®]			
TITLE CBGA256T.8-16x16 CERAMIC BALL GRID ARRAY			
SCALE 8:1	SIZE A	DRAWING NO. 581696	REV A
DO NOT SCALE DRAWING		SHEET 3 OF 5	

**MODEL
CBGA WITH BALL**

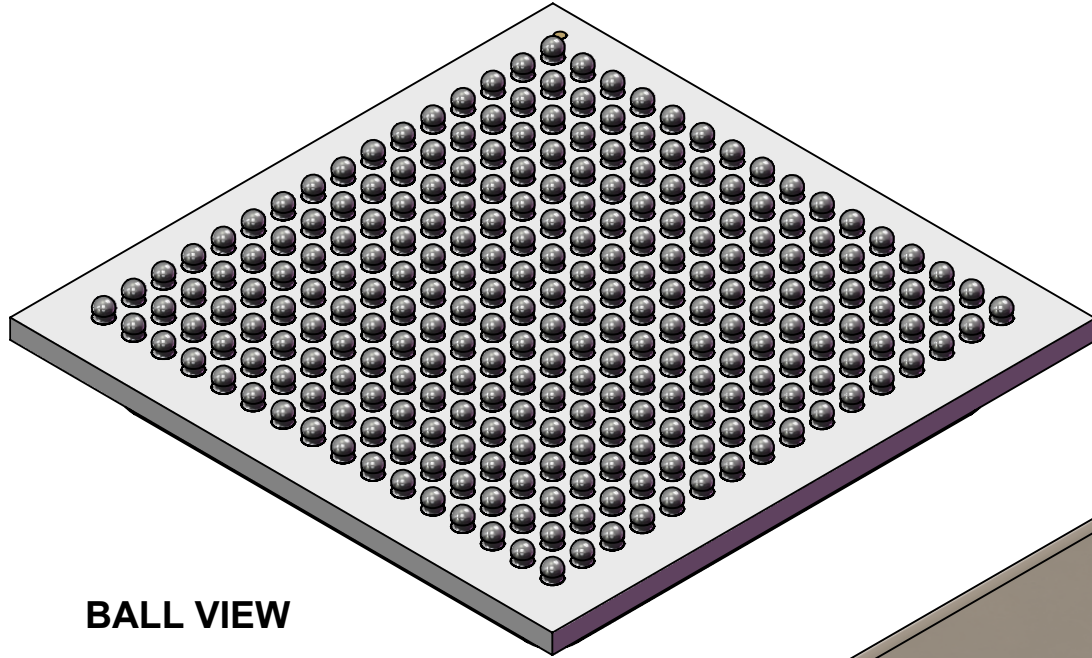

BALL VIEW

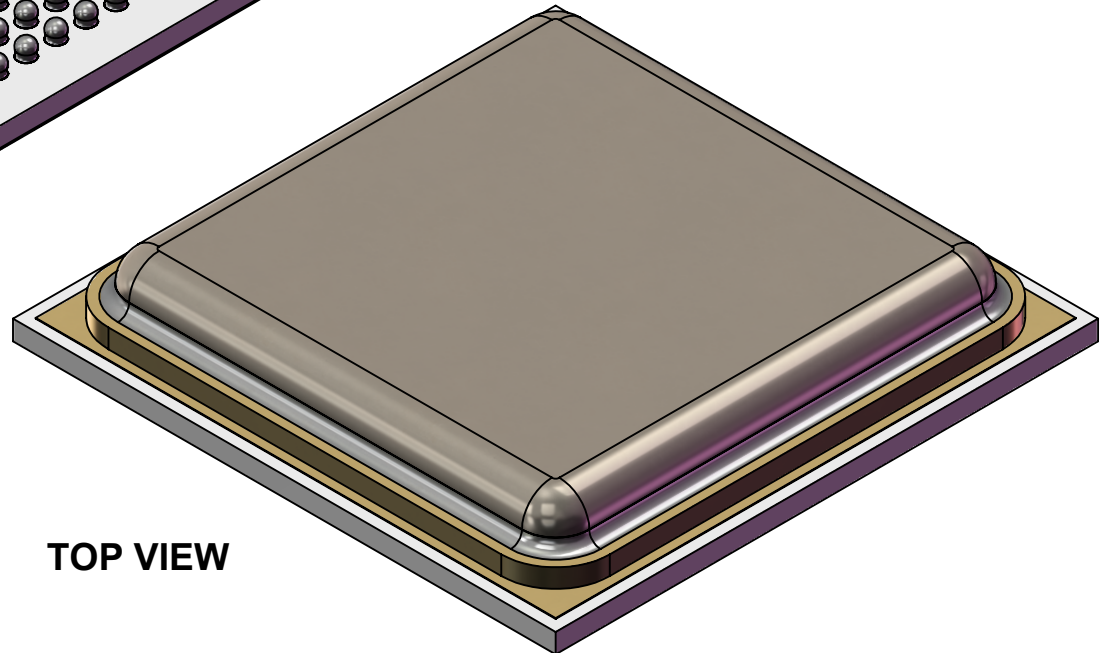

TOP VIEW

TopLine[®]			
TITLE CBGA256T.8-16x16 CERAMIC BALL GRID ARRAY			
SCALE	SIZE	DRAWING NO.	REV
6:1	A	581696	A
DO NOT SCALE DRAWING			SHEET 4 OF 5

**MODEL
CLGA WITHOUT BALL**

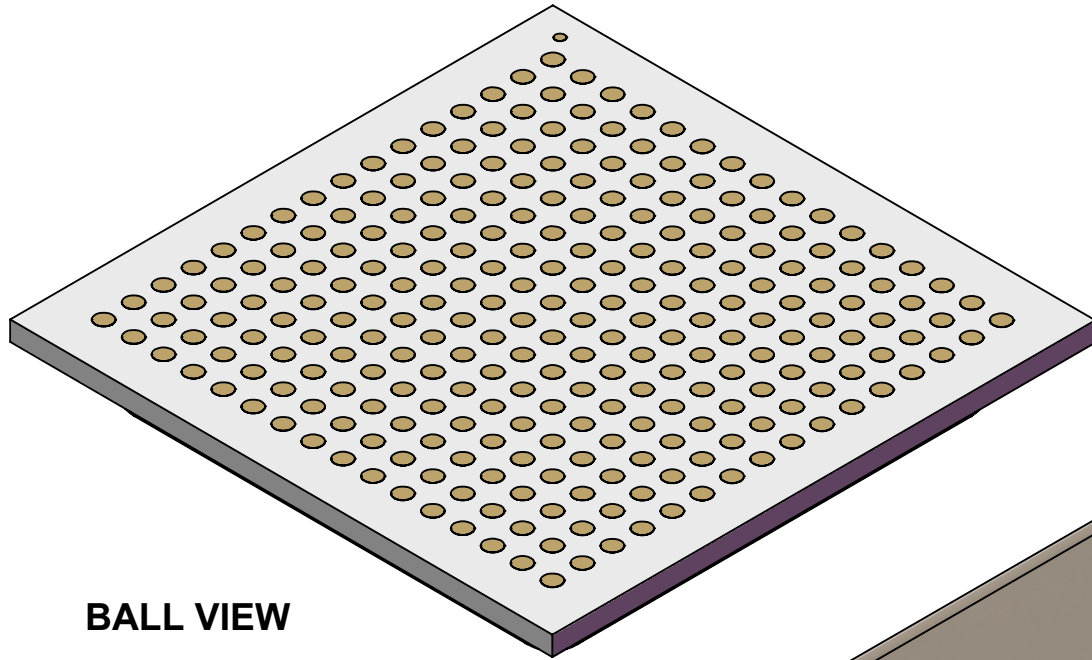

BALL VIEW

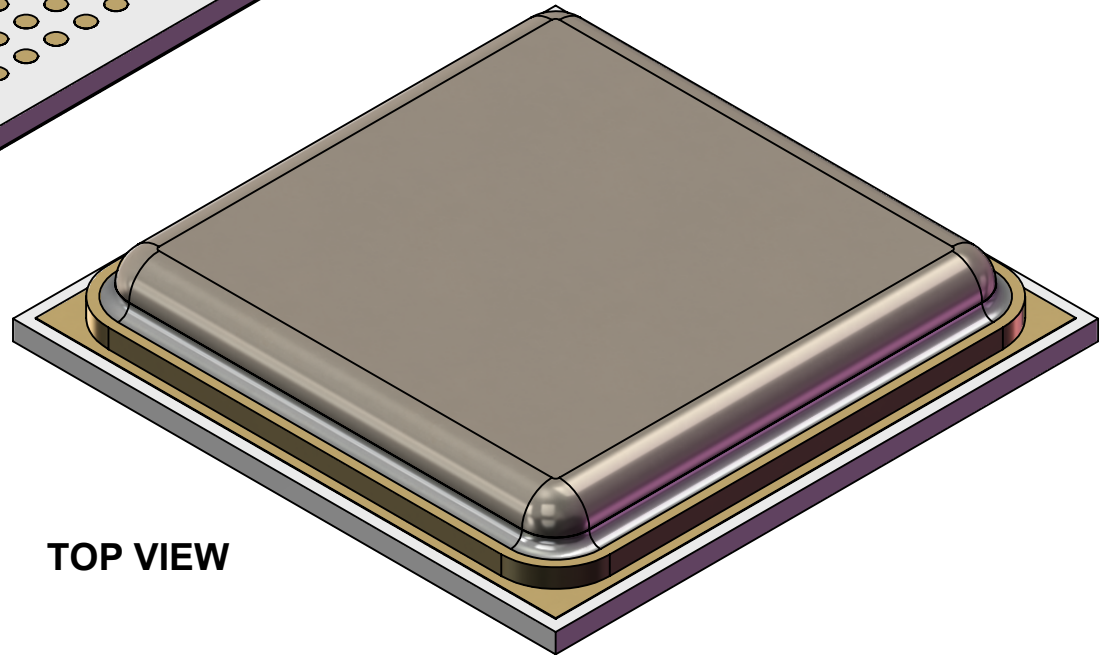

TOP VIEW

TopLine[®]			
TITLE CBGA256T.8-16x16 CERAMIC BALL GRID ARRAY			
SCALE	SIZE	DRAWING NO.	REV
7:1	A	581696	A
DO NOT SCALE DRAWING			SHEET 5 OF 5