

TOP VIEW

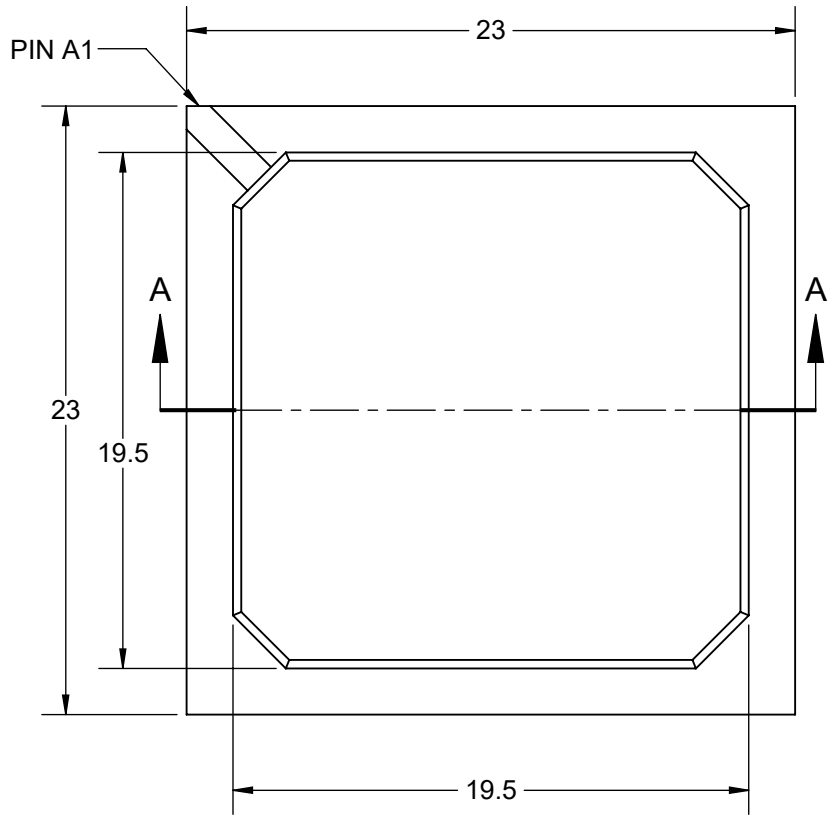

SIDE

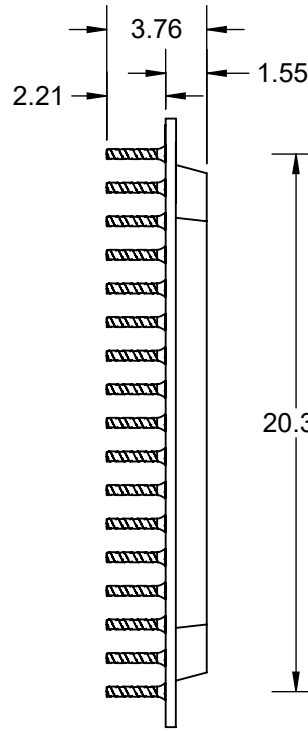

COLUMN VIEW

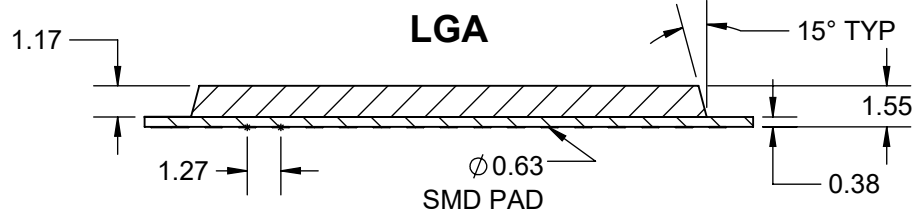
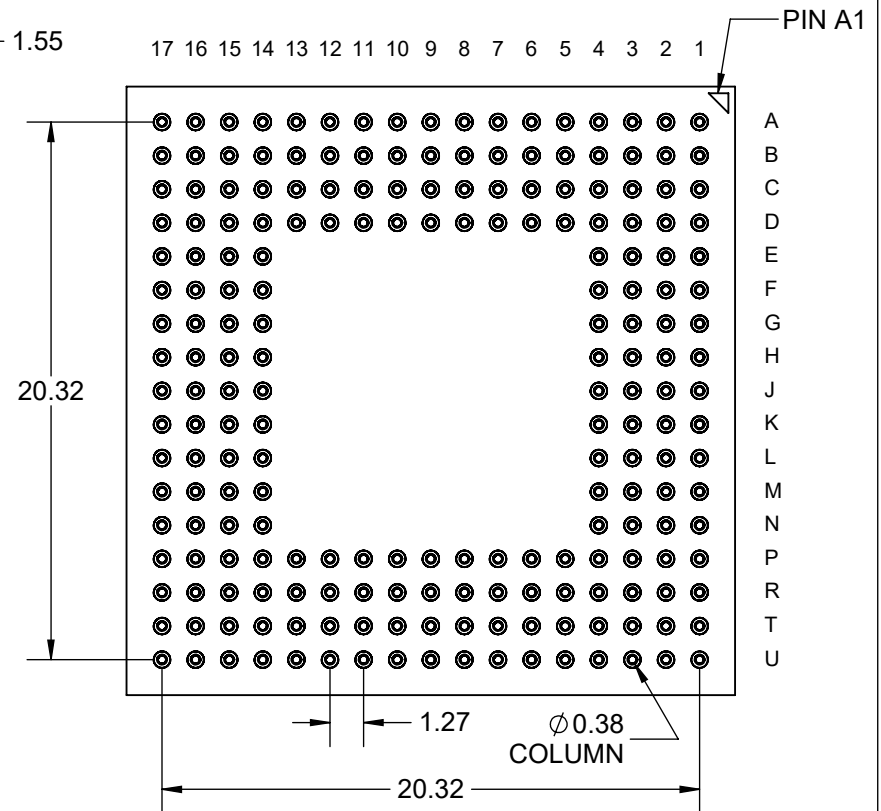

SECTION A-A
SCALE 3.5 : 1

Notes: (Unless Otherwise Specified).

- 1) ALL DIMENSIONS ARE IN MM.
- 2) COLUMN ALLOY: SEE PART NUMBER TABLE.
- 3) COLUMN DIAMETER (BEFORE REFLOW): $\phi 0.38$ (15 MIL).
- 4) SOLDER MASK DEFINED PAD OPENING: 0.635mm (25MIL).
- 5) SUBSTRATE MATERIAL: BT.
- 6) DAISY CHAIN PATTERN (SEE PAGE 2).
- 7) MSL-3 RECOMMENDED BAKING 24 HOURS @ 125°C TO REMOVE MOISTURE PRIOR SOLDERING TO PC BOARD.

PART NUMBER TABLE

PART NUMBER	COLUMN	FILLET	COL DIA	PAD DIA
PCGA208T1.27-DC171D	Pb80/Sn20 Copper Wrap	Sn63/Pb37	$\phi 0.38$	$\phi 0.63$
LGA208T1.27-DC171D	NONE	NONE	NONE	$\phi 0.63$

APPROVALS	DATE				
DRAWN T. Au	4/29/2020				
ENG M. Hart	4/29/2020	TITLE PCGA208T1.27-DC171D DAISY CHAIN			
MFG		SCALE 3.5:1	SIZE A	DRAWING NO. 160024	REV A
QA					
CUST		DO NOT SCALE DRAWING			SHEET 1 OF 4
REVISED					

PAD VIEW

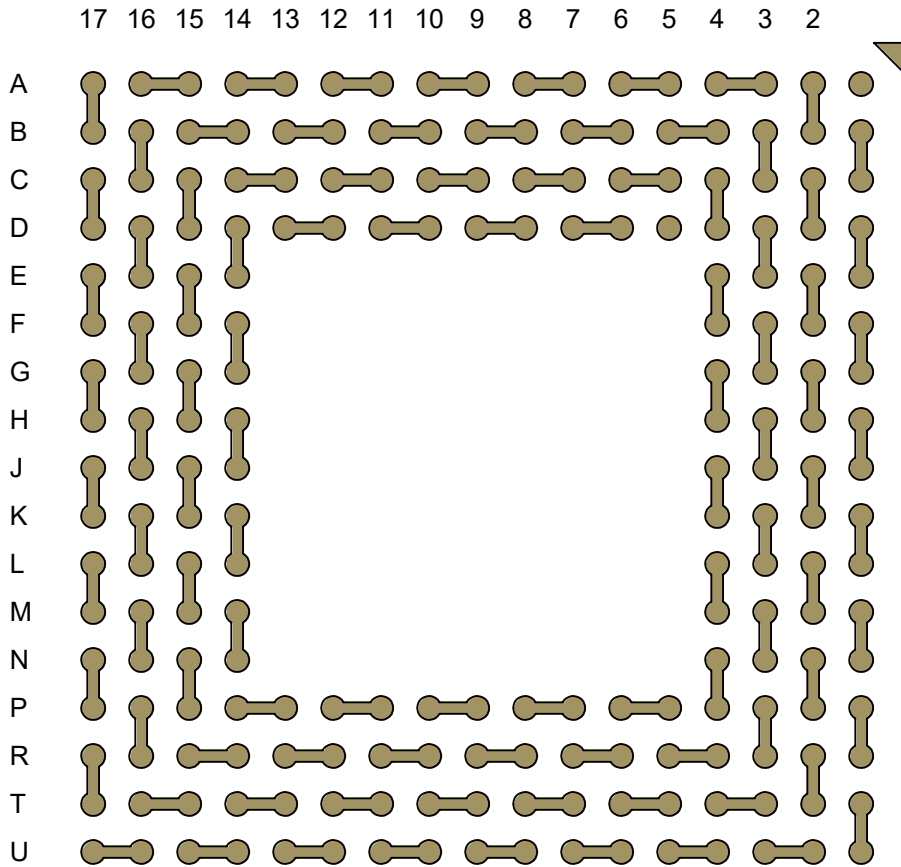

BOTTOM SIDE (TOP X-RAY VIEW)

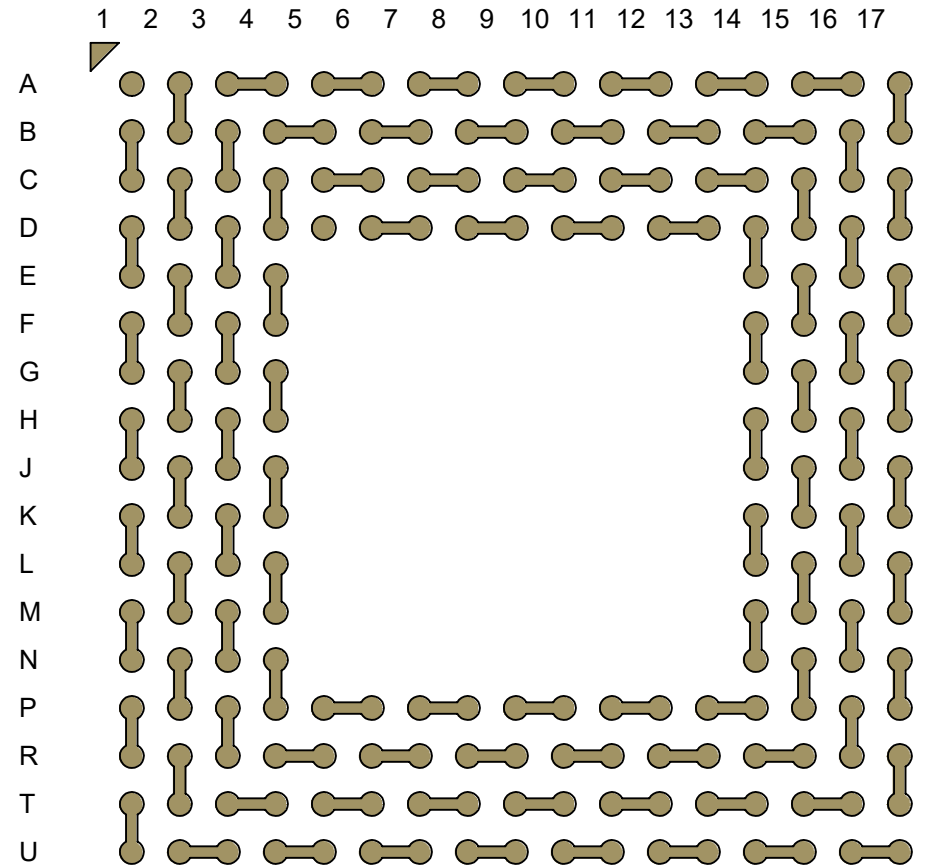

Notes:

- 1) PCB BOARD DIMENSIONS ARE PRESENTED ONLY AS A GUIDELINE. DESIGNERS SHOULD USE THEIR OWN EXPERIENCE WHEN DESIGNING PCB.

TopLine®			
TITLE PCGA208T1.27-DC171D DAISY CHAIN			
SCALE	SIZE	DRAWING NO.	REV
5:1	A	160024	A
DO NOT SCALE DRAWING			SHEET 2 OF 4

SOLDER PIN OPTIONS

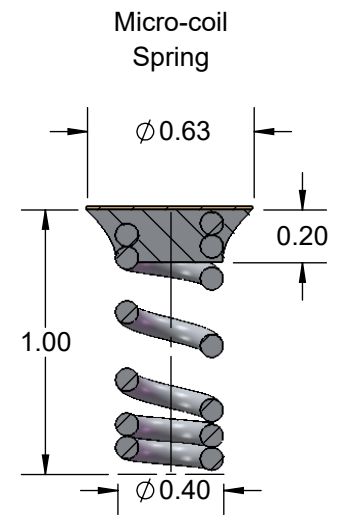
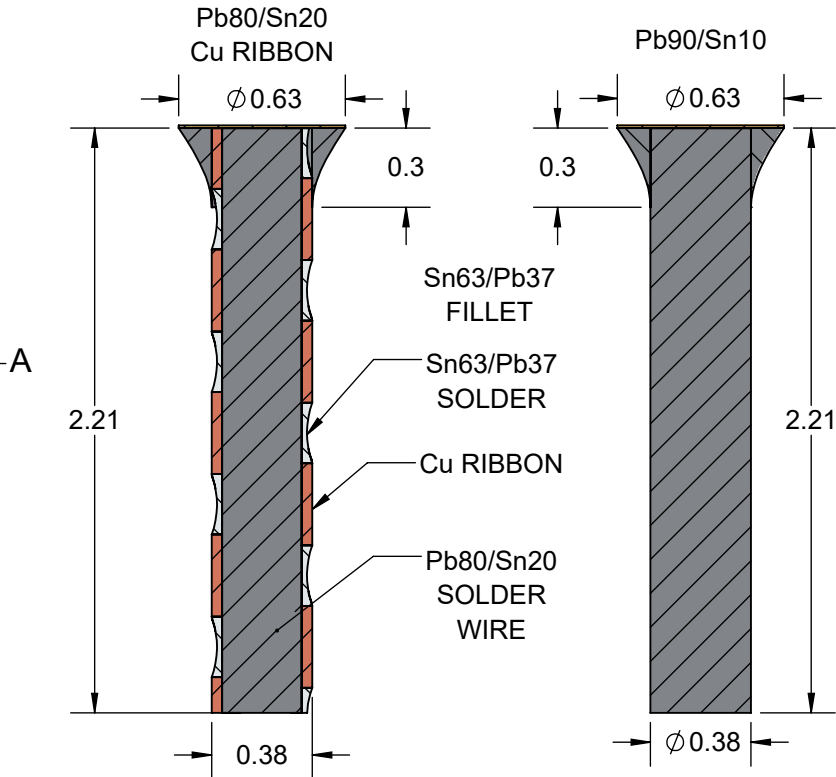
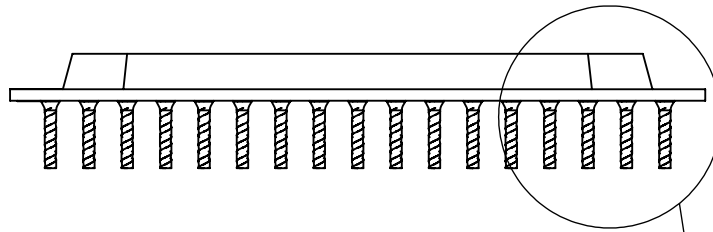

DETAIL A
SCALE 8 : 1

SECTION B-B
SCALE 35 : 1

SECTION C-C
SCALE 35 : 1

SECTION D-D
SCALE 35 : 1

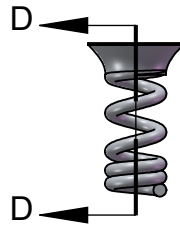
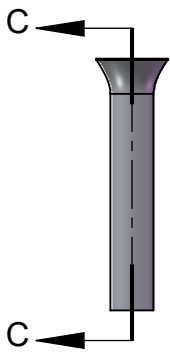
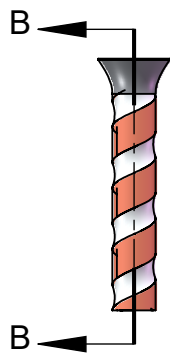

Pb80/Sn20
Cu RIBBON
SCALE 15:1

Pb90/Sn10
SCALE 15:1

Micro-Coil
Spring
SCALE 20:1

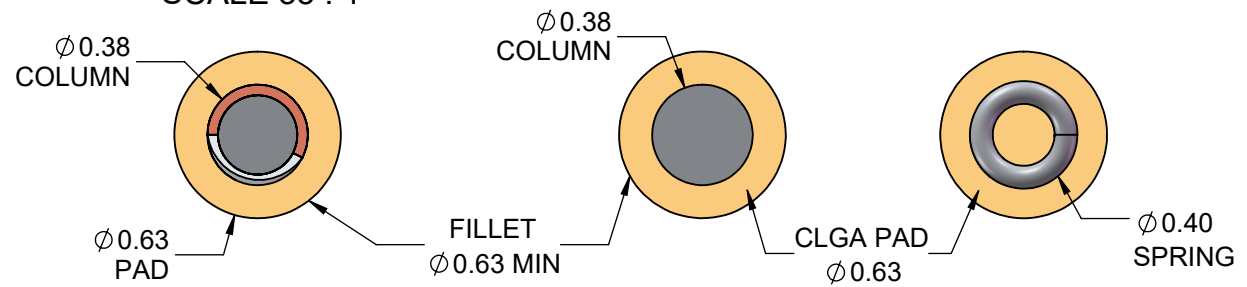

PART NUMBER OPTIONS	
PART NUMBER	SOLDER PIN
PGA208T1.27-DC171D	Pb80/Sn20 Cu RIBBON
PCGA208T1.27A-DC171D	Pb90/Sn10
PCGA208T1.27M-DC171D	Micro-Coil
LGA208T1.27G-DC171D	NONE

TopLine®

TITLE PCGA208T1.27-DC171D
 DAISY CHAIN

SCALE 4:1	SIZE A	DRAWING NO. 160024	REV A
--------------	-----------	-----------------------	----------

DO NOT SCALE DRAWING SHEET 3 OF 4

MODEL

TOP

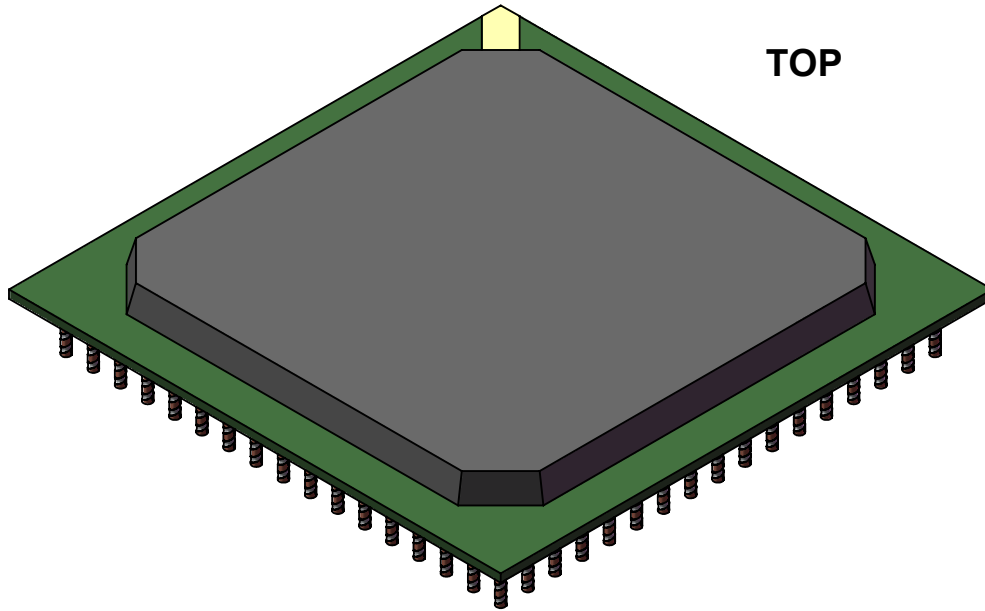

BOTTOM

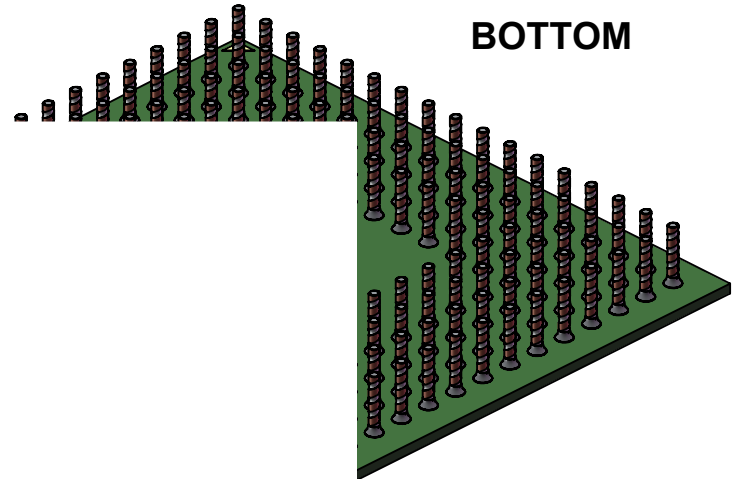

TopLine[®]

TITLE PCGA208T1.27-DC171D
DAISY CHAIN

SCALE 4:1	SIZE A	DRAWING NO. 160024	REV A
--------------	-----------	-----------------------	----------

DO NOT SCALE DRAWING

SHEET 4 OF 4