

6 CHCA J9K

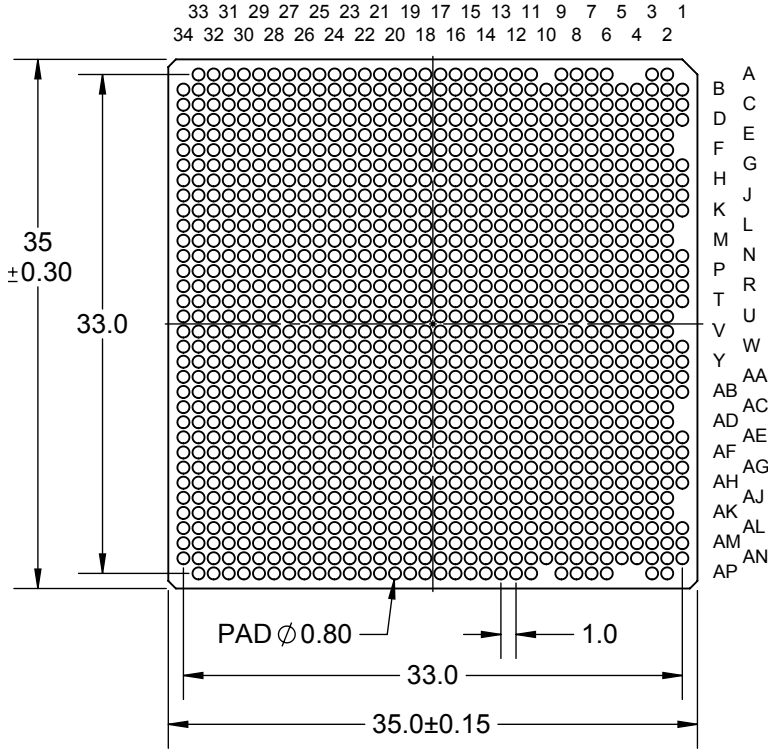

G89 J9K

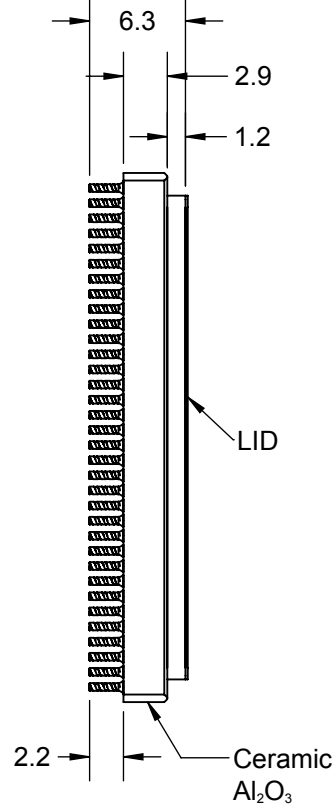

HCD J9K

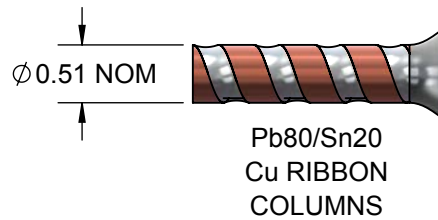
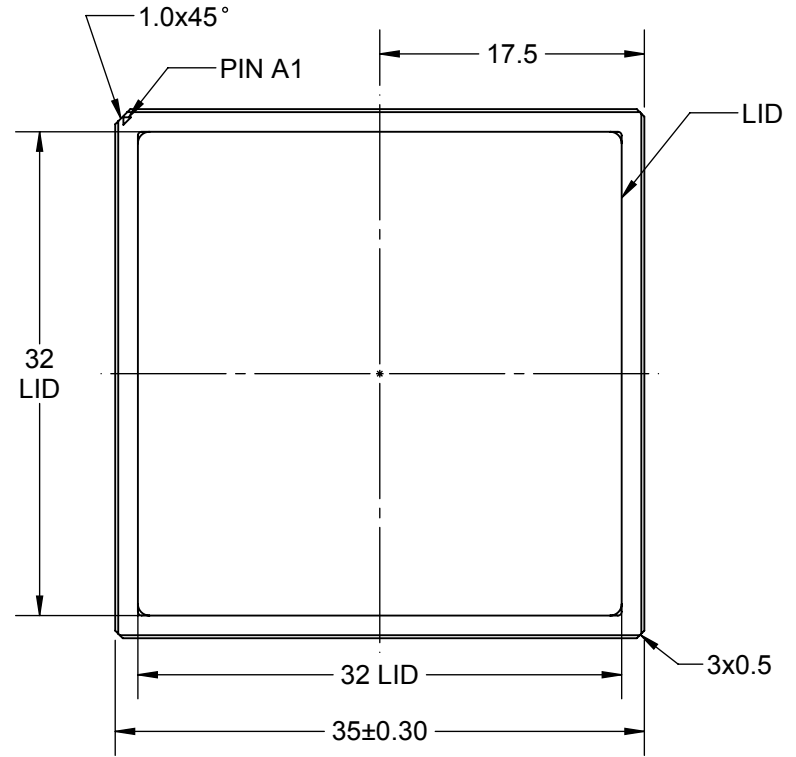

COLUMNS DEPOPULATED:

A1, A4, A5, A10, A34, E1, F1, L1, M1, U1, V1,
AC1, AD1, AJ1, AK1, AP1, AP4, AP5, AP10, AP34.

D5FHBI A69F CDHCBG			
D5FHBI A69F	89	GC @ 9F D-B	@8
CCGA1136T1.0-DC342D	YES	YES	YES

- Notes: (Unless Otherwise Specified).
 1) DIMENSIONS ARE IN mm.
 2) SHOWN WITH COLUMNS.
 3) SHOWN WITH LID COVER ATTACHED.

APPROVALS	DATE	TopLine®		
DRAWN T.Au	4/17/2020			
ENG M. Hart	4/17/2020	TITLE CCGA1136T1.0-DC342D COLUMN GRID ARRAY		
MFG		SCALE 2:1	SIZE A	DRAWING NO. 160142
QA				REV A
CUST				
REVISED		DO NOT SCALE DRAWING		SHEET 1 OF 4

85 -GM7 <5 -B'D5 HH9 FB

7 C@ AB'fD5 8LJ-9K

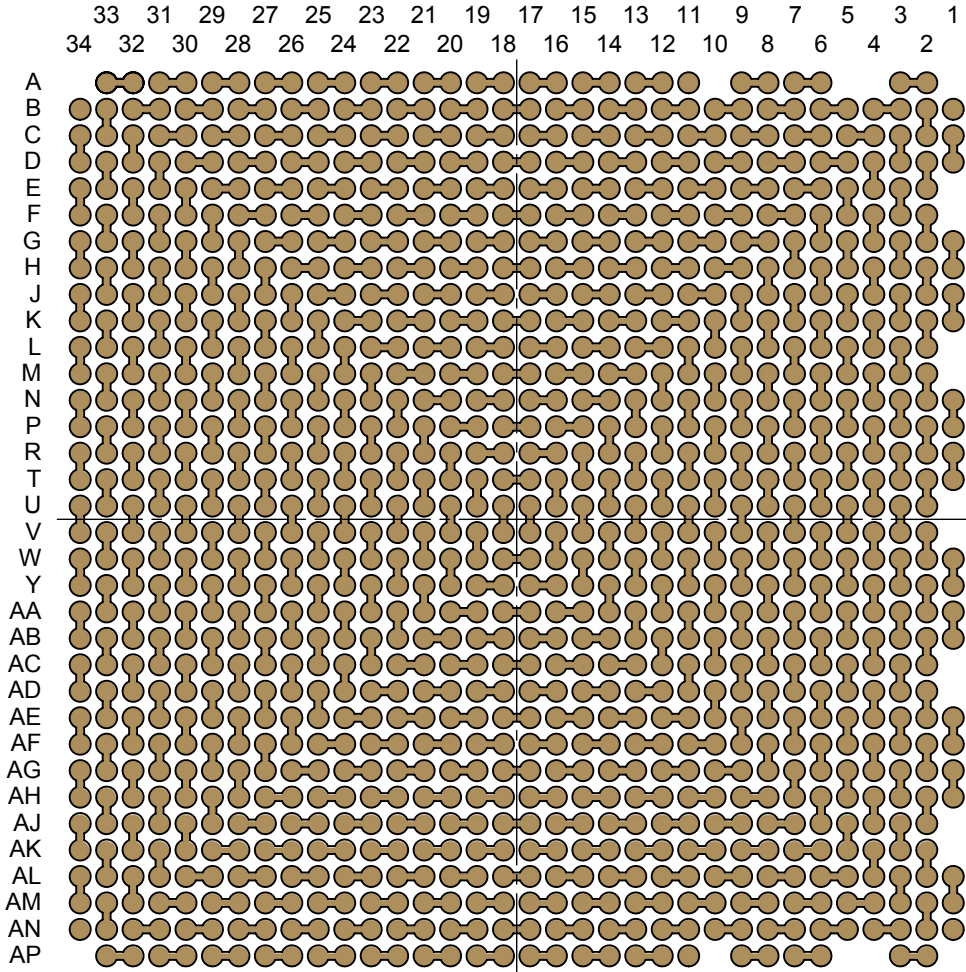

6 CHHCA 'L!F5 MJ-9K 98 : FCA 'HCD

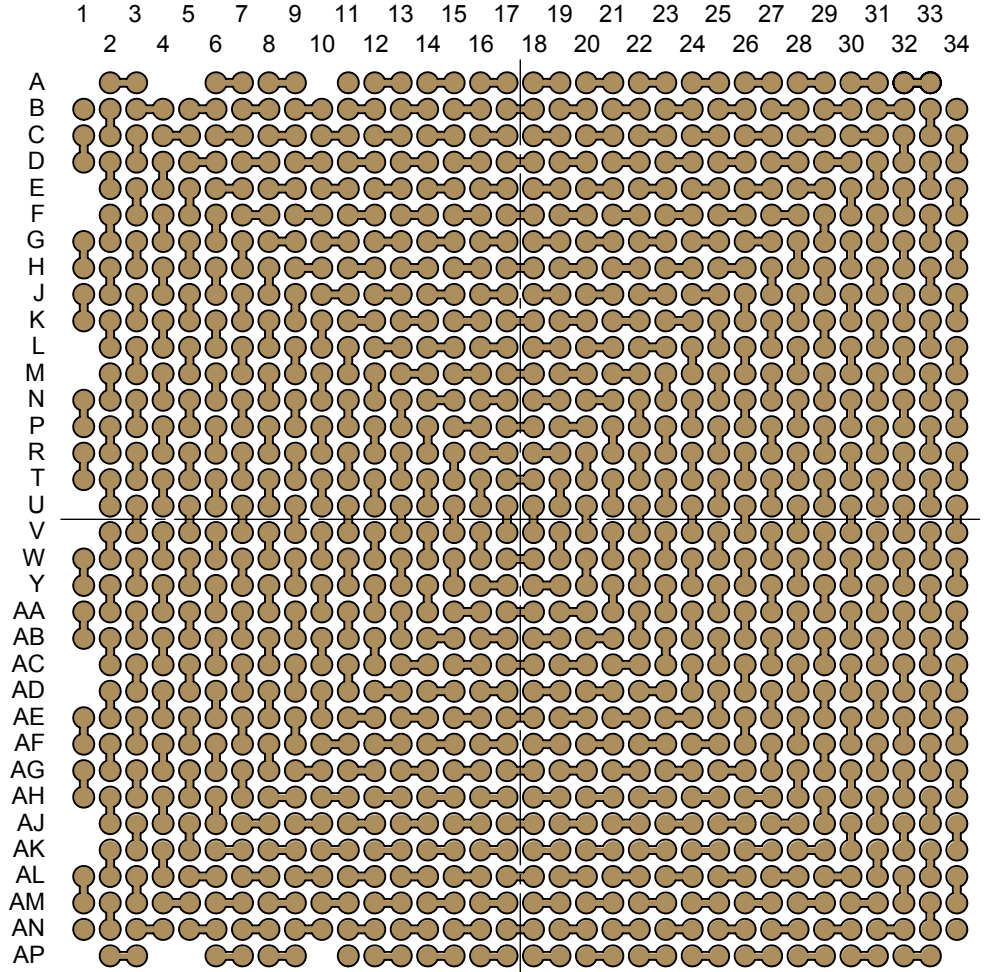

COLUMNS DEPOPULATED:

- A1, A4, A5, A10, A34, E1, F1, L1, M1, U1, V1,
- AC1, AD1, AJ1, AK1, AP1, AP4, AP5, AP10, AP34.

TopLine®			
TITLE		CCGA1136T1.0-DC342D COLUMN GRID ARRAY	
SCALE	SIZE	DRAWING NO.	REV
3.5:1	A	160142	A
DO NOT SCALE DRAWING			SHEET 2 OF 4

GC @ 9F'D-B'CDH-CBG

Pb80/Sn20
Cu RIBBON

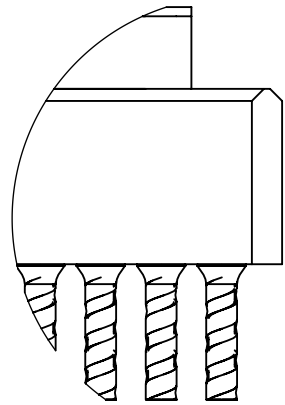
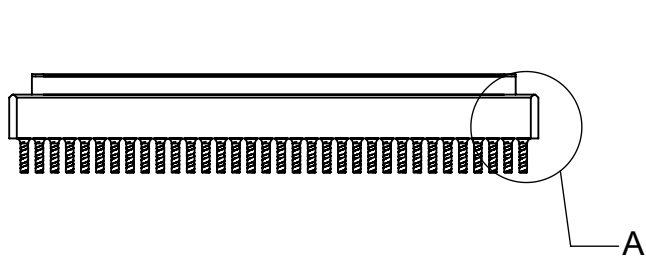

DETAIL A
SCALE 8 : 1

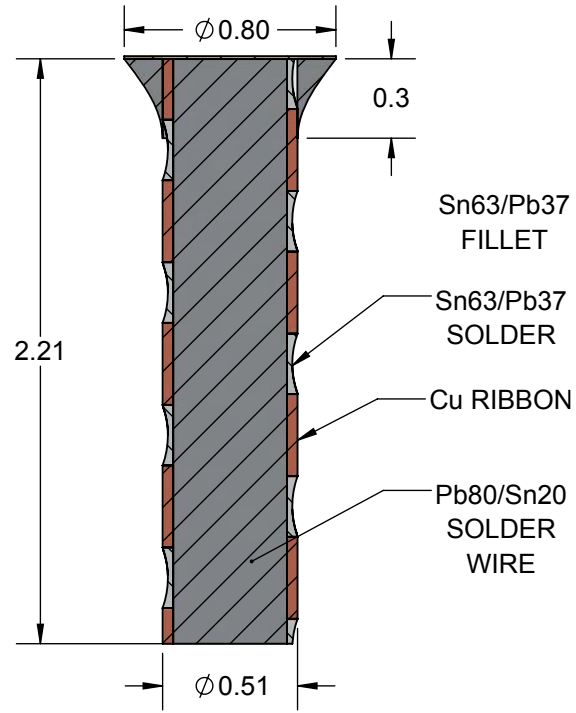

SECTION B-B
SCALE 35 : 1

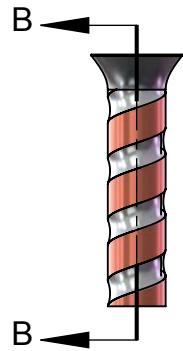
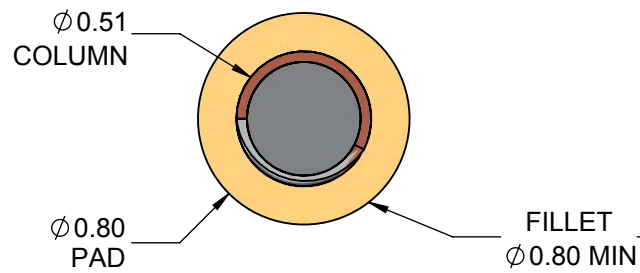

Pb80/Sn20
Cu RIBBON
SCALE 15:1

TopLine®

TITLE CCGA1136T1.0-DC342D
COLUMN GRID ARRAY

SCALE	SIZE	DRAWING NO.	REV
4:1	A	160142	A

DO NOT SCALE DRAWING

SHEET 3 OF 4

AC89@
77; 5%% * H%\$!87' (&&
DV, \$#Gb&\$'7 CDD9F`K F5 DD98
7C@ ABG

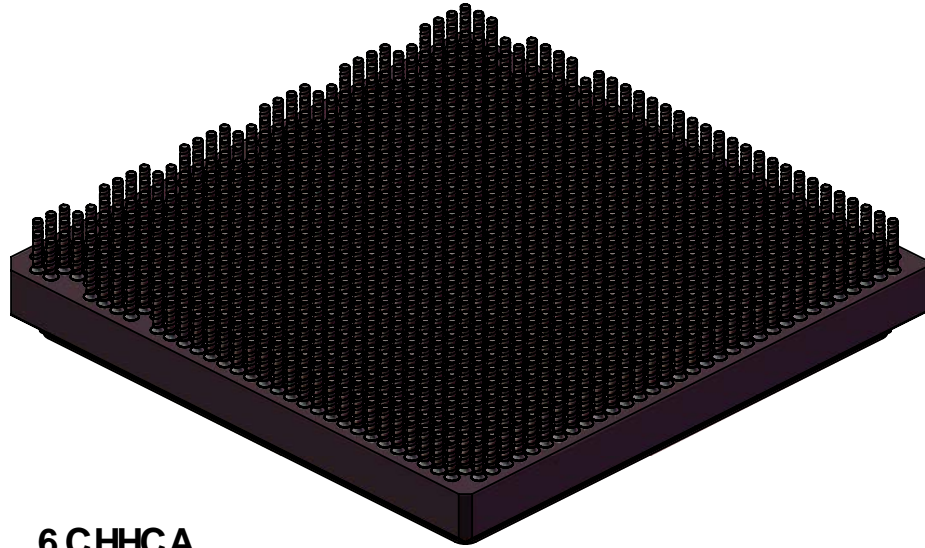

6 CHCA

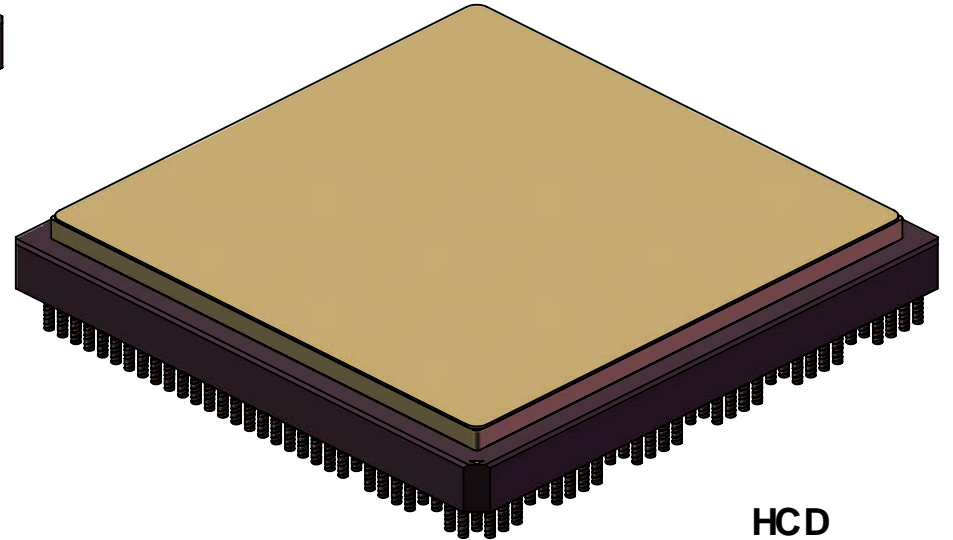

HCD

TopLine®			
TITLE		CCGA1136T1.0-DC342D COLUMN GRID ARRAY	
SCALE	SIZE	DRAWING NO.	REV
2.5:1	A	160142	A
DO NOT SCALE DRAWING			SHEET 4 OF 4