

### BOTTOM VIEW

### SIDE VIEW

### TOP VIEW WITH LID

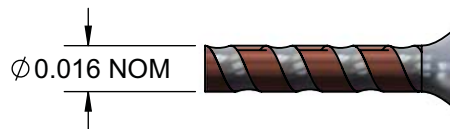
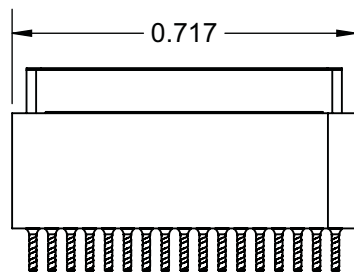
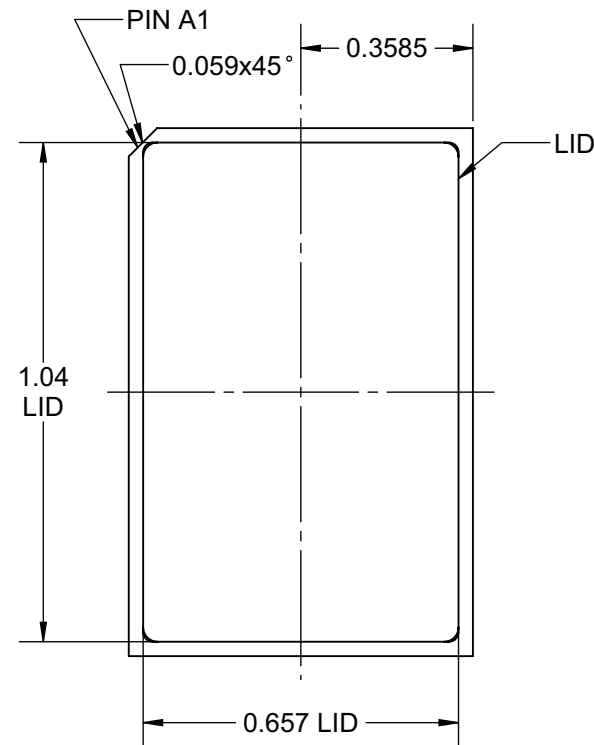
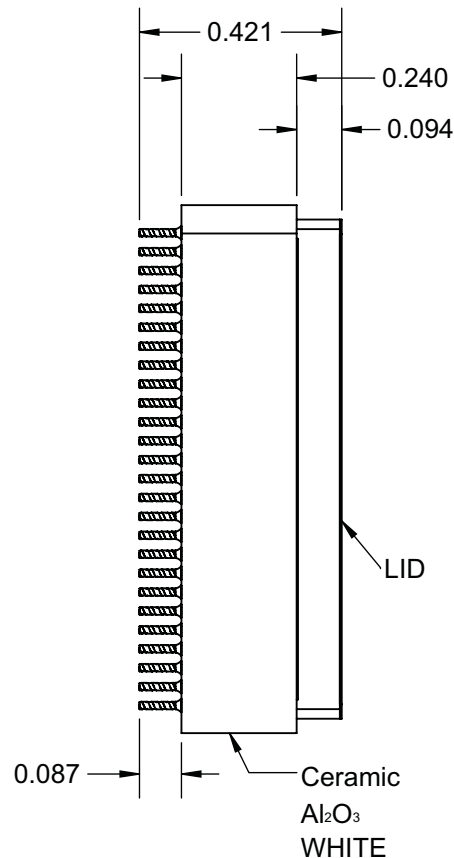
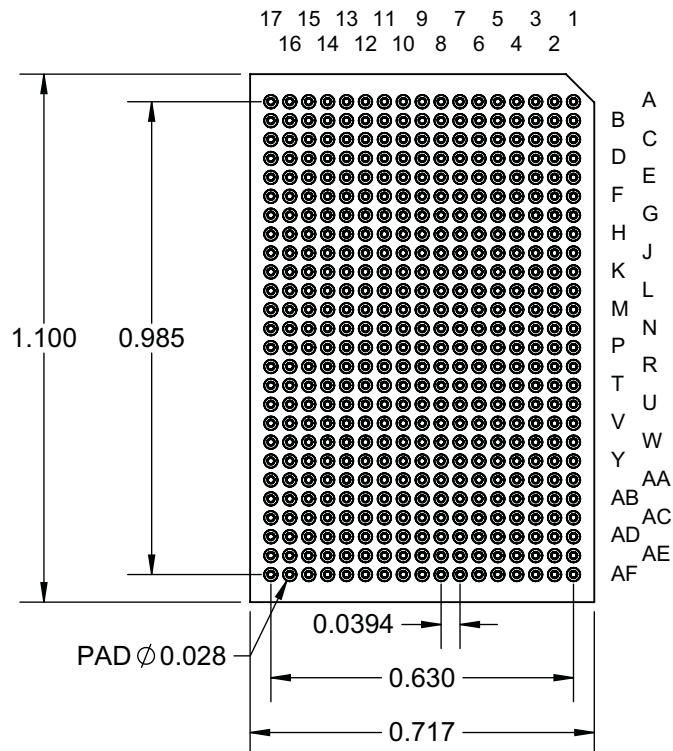

**Pb80/Sn20**  
**Pb85/Sn15**  
**Cu RIBBON**

- Notes: (Unless Otherwise Specified).  
 1) DIMENSIONS ARE INCHES.  
 2) SHOWN WITH COLUMNS.  
 3) SHOWN WITH LID COVER ATTACHED.  
 4) PART NUMBER CCGA441T1.0-17x26.

PART NUMBER OPTIONS			
PART NUMBER	DUMMY DIE	SOLDER PIN	LID
CCGA441T1.0-17x26	YES	YES	YES

APPROVALS	DATE	<b>TopLine®</b>			
DRAWN T. Au	02/19/2020				
ENG M. Hart	02/19/2020	TITLE CCGA441T1.0-17x26 DUMMY COLUMN GRID ARRAY			
MFG		SCALE 2.5:1	SIZE A	DRAWING NO. 160072	REV A
QA		DO NOT SCALE DRAWING			SHEET 1 OF 7
CUST					
REVISED					

### BOTTOM VIEW

### SIDE VIEW

### TOP VIEW WITH LID

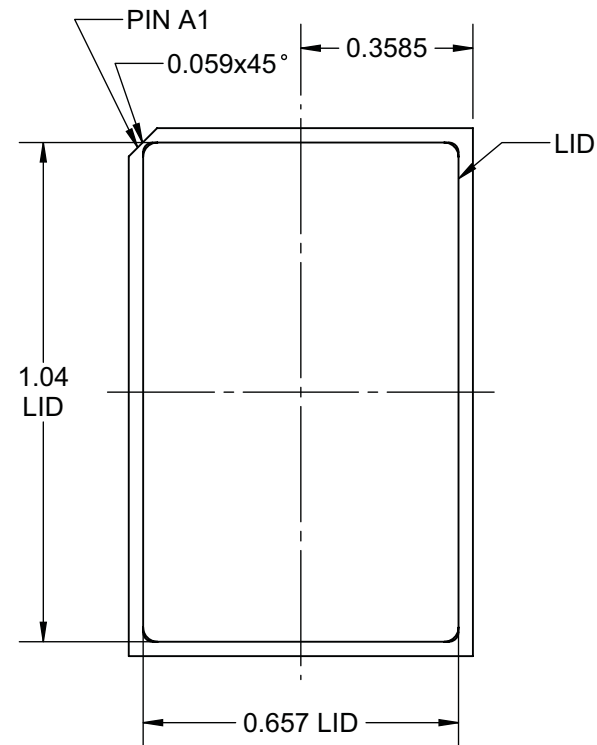
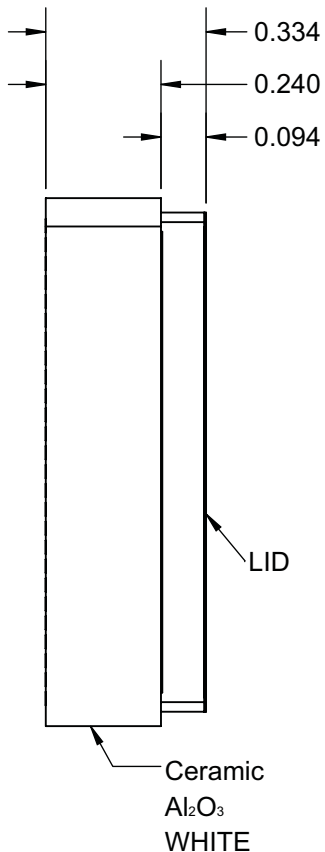
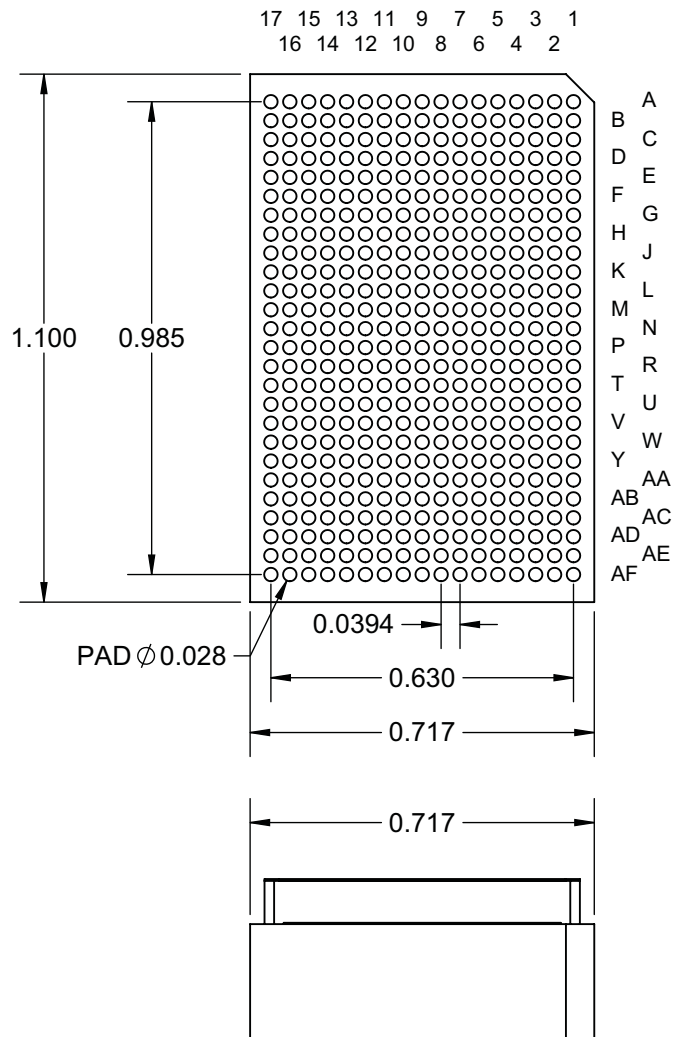

- Notes: (Unless Otherwise Specified).  
 1) DIMENSIONS ARE INCHES.  
 2) SHOWN WITHOUT COLUMNS.  
 3) SHOWN WITH LID COVER ATTACHED.  
 4) PART NUMBER CLGA441T1.0-17x26.

PART NUMBER OPTIONS			
PART NUMBER	DUMMY DIE	SOLDER PIN	LID
CLGA441T1.0-17x26	YES	NONE	YES

APPROVALS	DATE	<b>TopLine®</b>			
DRAWN T. Au	02/19/2020				
ENG M. Hart	02/19/2020	TITLE CCGA441T1.0-17x26 DUMMY COLUMN GRID ARRAY			
MFG		SCALE	SIZE	DRAWING NO.	REV
QA		2.5:1	A	160072	A
CUST		DO NOT SCALE DRAWING			SHEET 2 OF 7
REVISED					

# DAISY CHAIN PATTERN

## COLUMN (PAD) VIEW

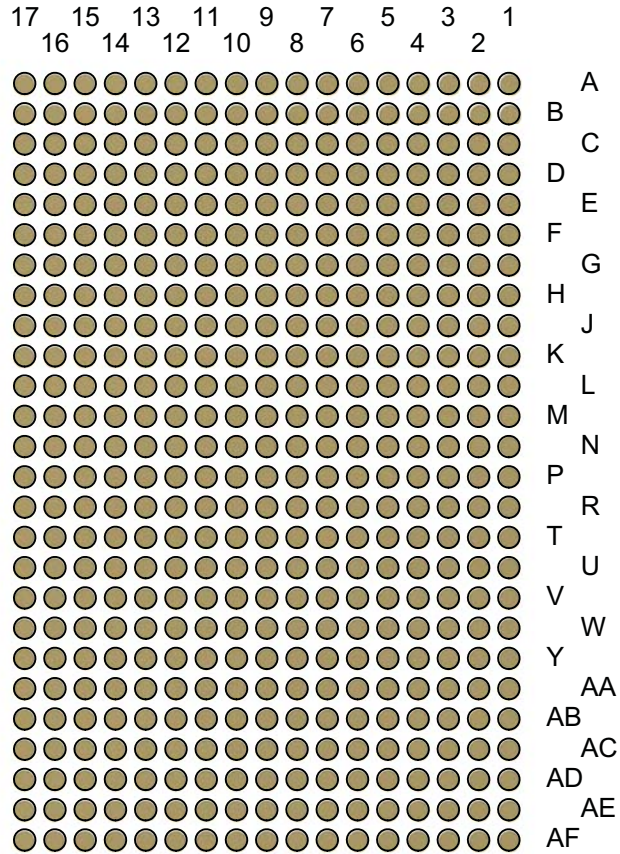

## BOTTOM X-RAY VIEWED FROM TOP

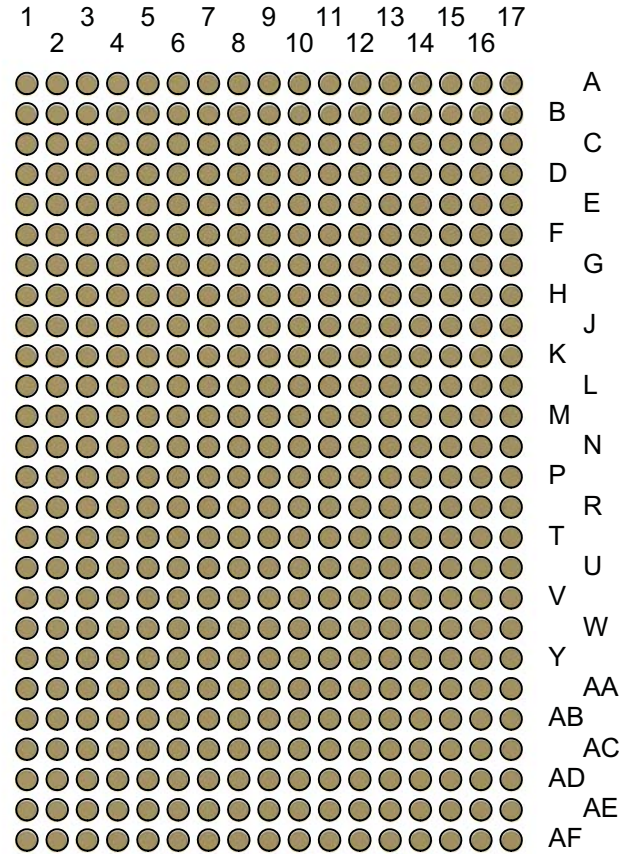

**TopLine®**

TITLE CCGA441T1.0-17x26  
DUMMY COLUMN GRID ARRAY

SCALE 4:1	SIZE A	DRAWING NO. 160072	REV A
--------------	-----------	-----------------------	----------

DO NOT SCALE DRAWING

SHEET 3 OF 7

# SOLDER PIN OPTIONS

DIMENSIONS: INCHES

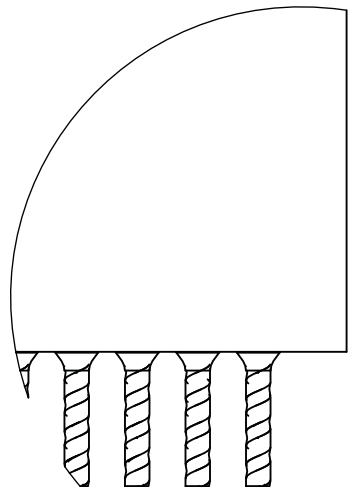
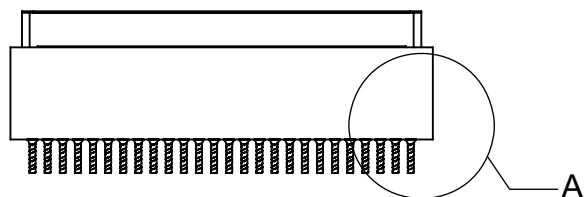

DETAIL A  
SCALE 8 : 1

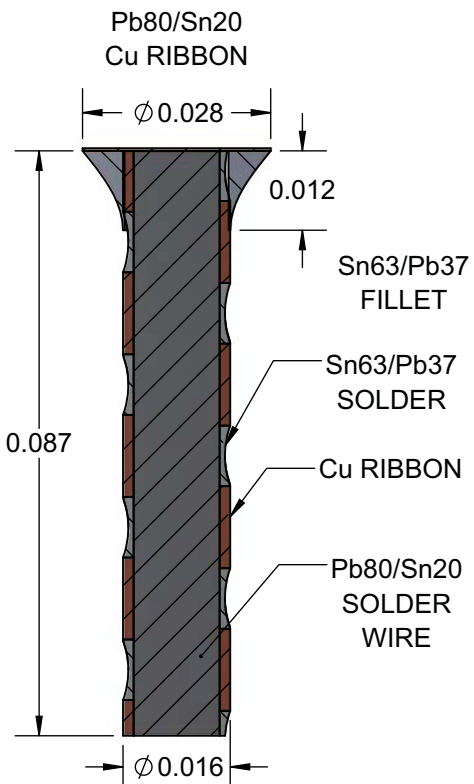

SECTION B-B  
SCALE 35 : 1

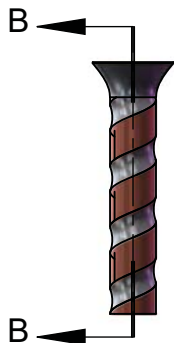
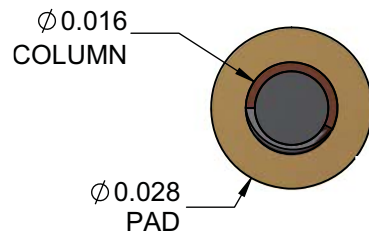

Pb80/Sn20  
Cu RIBBON  
SCALE 15:1

<b>TopLine<sup>®</sup></b>			
TITLE CCGA441T1.0-17x26 DUMMY COLUMN GRID ARRAY			
SCALE 8:1	SIZE A	DRAWING NO. 160072	REV A
DO NOT SCALE DRAWING		SHEET 4 OF 7	

# SOLDER PIN OPTIONS

DIMENSIONS: INCHES

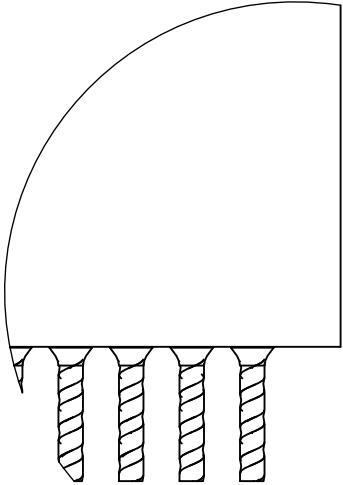
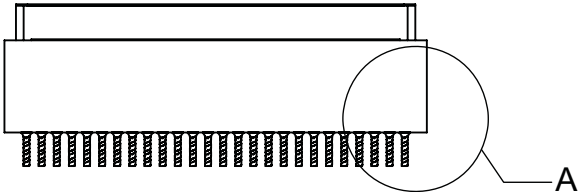

DETAIL A  
SCALE 8 : 1

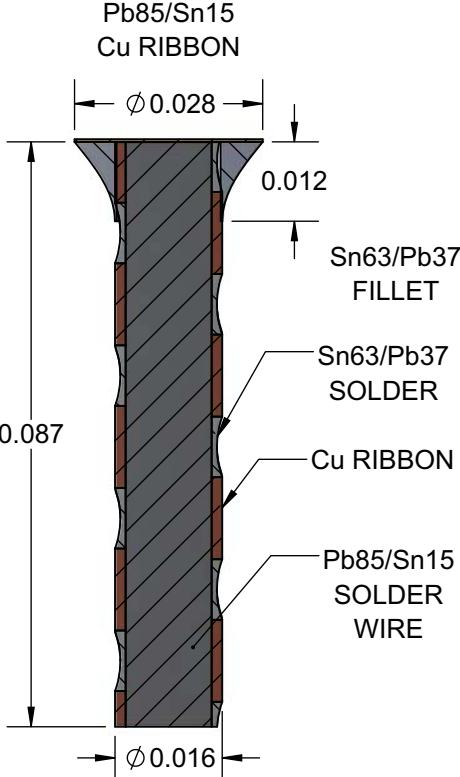

SECTION B-B  
SCALE 35 : 1

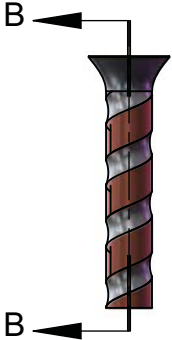

Pb85/Sn15  
Cu RIBBON  
SCALE 15:1

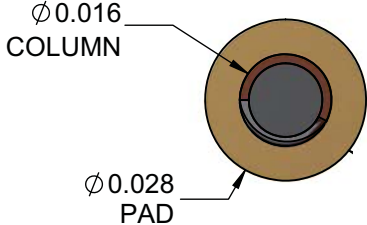

<b>TopLine®</b>			
TITLE CCGA441T1.0-17x26 DUMMY COLUMN GRID ARRAY			
SCALE 8:1	SIZE A	DRAWING NO. 160072	REV A
DO NOT SCALE DRAWING			SHEET 5 OF 7

**MODEL**  
**CLGA441T1.0-17x26**  
**LID/COVER ATTACHED**

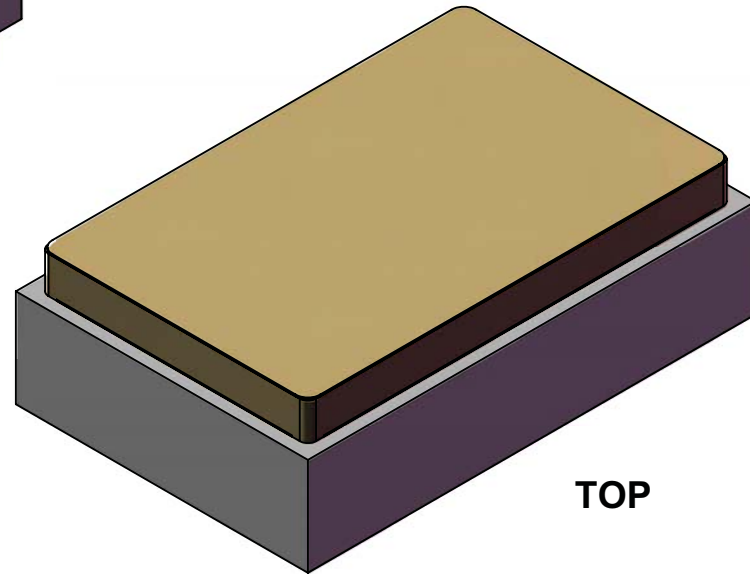
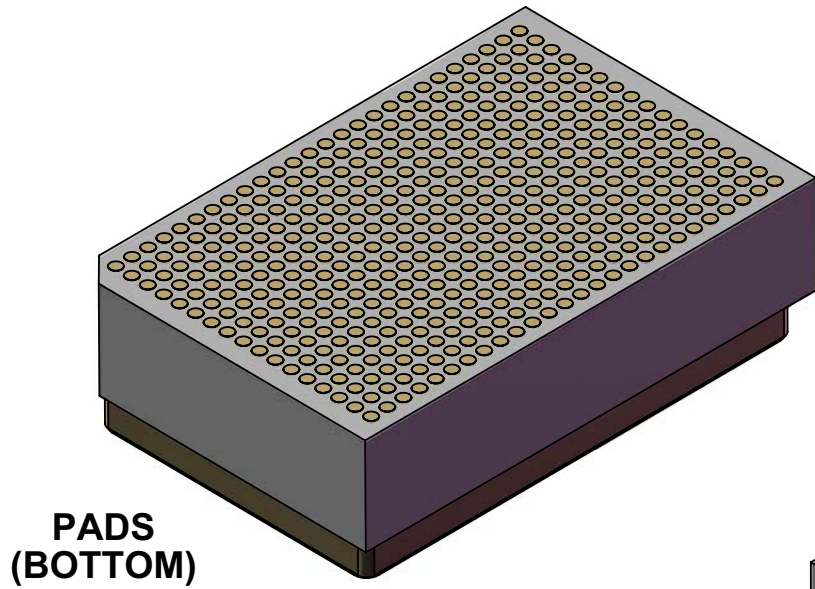

<b>TopLine®</b>			
TITLE CCGA441T1.0-17x26 DUMMY COLUMN GRID ARRAY			
SCALE 3:1	SIZE A	DRAWING NO. 160072	REV A
DO NOT SCALE DRAWING			SHEET 6 OF 7

**MODEL**  
**CCGA441T1.0-17x26**  
**Pb80/Sn20 ~ Pb85/Sn15 COPPER WRAPPED**  
**COLUMNS**

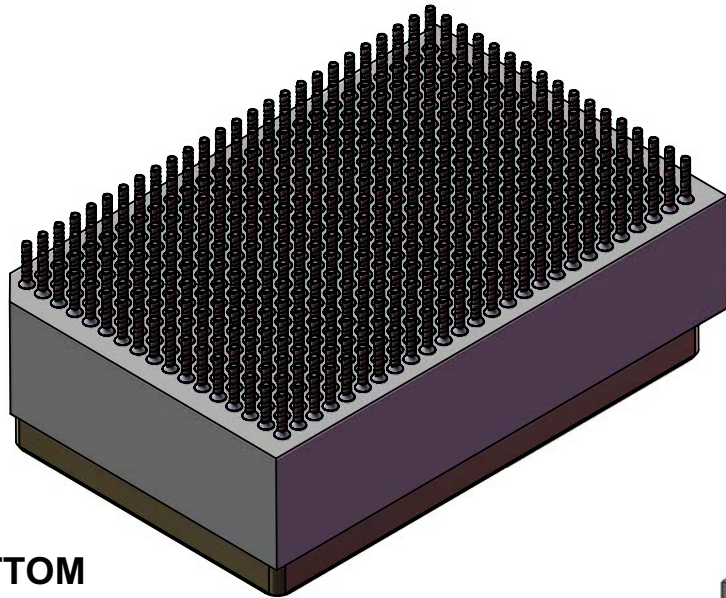

**BOTTOM**

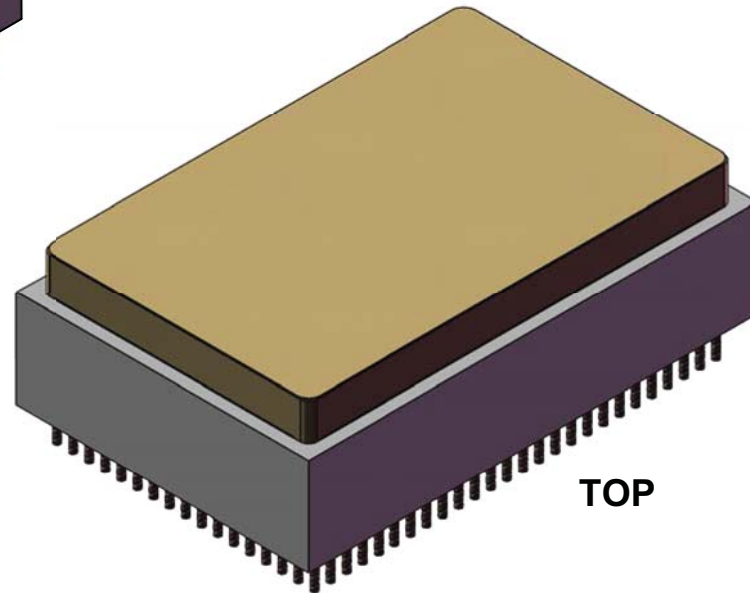

**TOP**

<b>TopLine®</b>			
TITLE CCGA441T1.0-17x26 DUMMY COLUMN GRID ARRAY			
SCALE 3:1	SIZE A	DRAWING NO. 160072	REV A
DO NOT SCALE DRAWING			SHEET 7 OF 7