

TOP VIEW

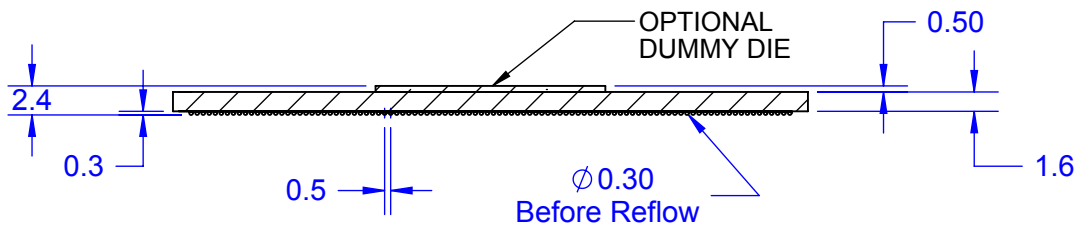

SECCION A-A

BALL VIEW

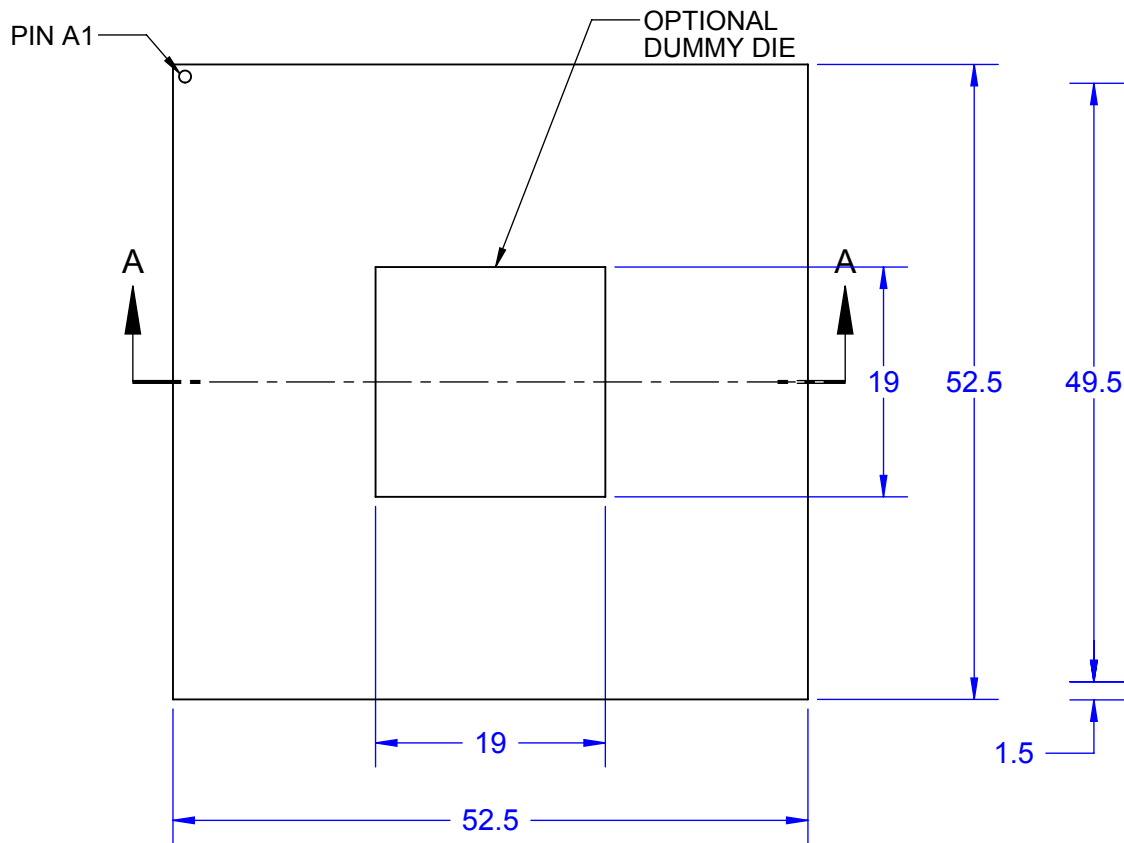
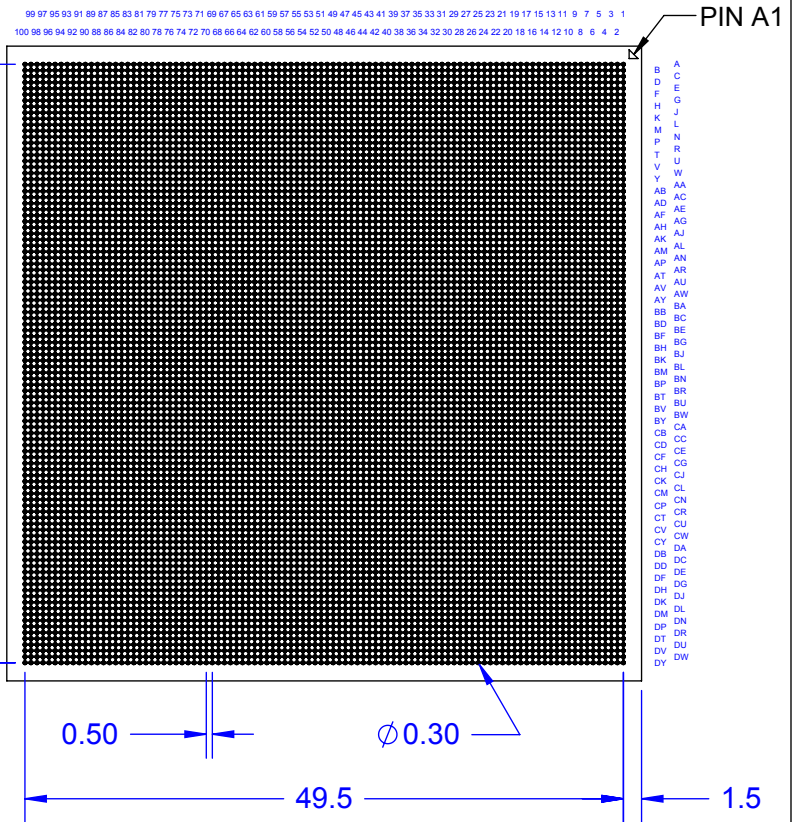

Notes: (Unless Otherwise Specified).

- 1) ALL DIMENSIONS ARE IN MM.
- 2) SOLDER BALL ALLOY: SEE PART NUMBER TABLE.
- 3) BALL DIAMETER (BEFORE REFLOW): 0.305mm (12 MIL).
- 4) SOLDER MASK DEFINED PAD OPENING: 0.254mm (10 MIL).
- 5) PAD Cu DIAMETER: 0.356mm (14 MIL).
- 6) SUBSTRATE MATERIAL: FR4 (ALTERNATE BT).
- 7) DUMMY DIE IS OPTIONAL.
- 8) DAISY CHAIN PATTERN (SEE PAGE 2).
- 9) MSL-3 RECOMMENDED BAKING 24 HOURS @ 125°C TO REMOVE MOISTURE PRIOR SOLDERING TO PC BOARD.

PART NUMBER TABLE

PART NUMBER	BALL ALLOY	Pb-FREE	RoHS	Si DIE
LBGA10000T.5C-BUS	Sn96.5/Ag3.0/Cu0.5	YES	YES	NO
LBGA10000T.5C-BUS-D	Sn96.5/Ag3.0/Cu0.5	YES	YES	YES
LBGA10000T.5-BUS	Sn63/Pb37	NO	NO	NO
LBGA10000T.5-BUS-D	Sn63/Pb37	NO	NO	YES

APPROVALS	DATE				
DRAWN T.Au	10/26/13				
ENG M. Hart	10/26/13	TITLE LBGA10000T.5-BUS ALL PADS SHORTED			
MFG		SCALE 1.8:1	SIZE A	DRAWING NO. 559901	REV A
QA		DO NOT SCALE DRAWING			SHEET 1 OF 3
CUST					
REVISED					

BALL VIEW

99 97 95 93 91 89 87 85 83 81 79 77 75 73 71 69 67 65 63 61 59 57 55 53 51 49 47 45 43 41 39 37 35 33 31 29 27 25 23 21 19 17 15 13 11 9 7 5 3 1
 100 98 96 94 92 90 88 86 84 82 80 78 76 74 72 70 68 66 64 62 60 58 56 54 52 50 48 46 44 42 40 38 36 34 32 30 28 26 24 22 20 18 16 14 12 10 8 6 4 2

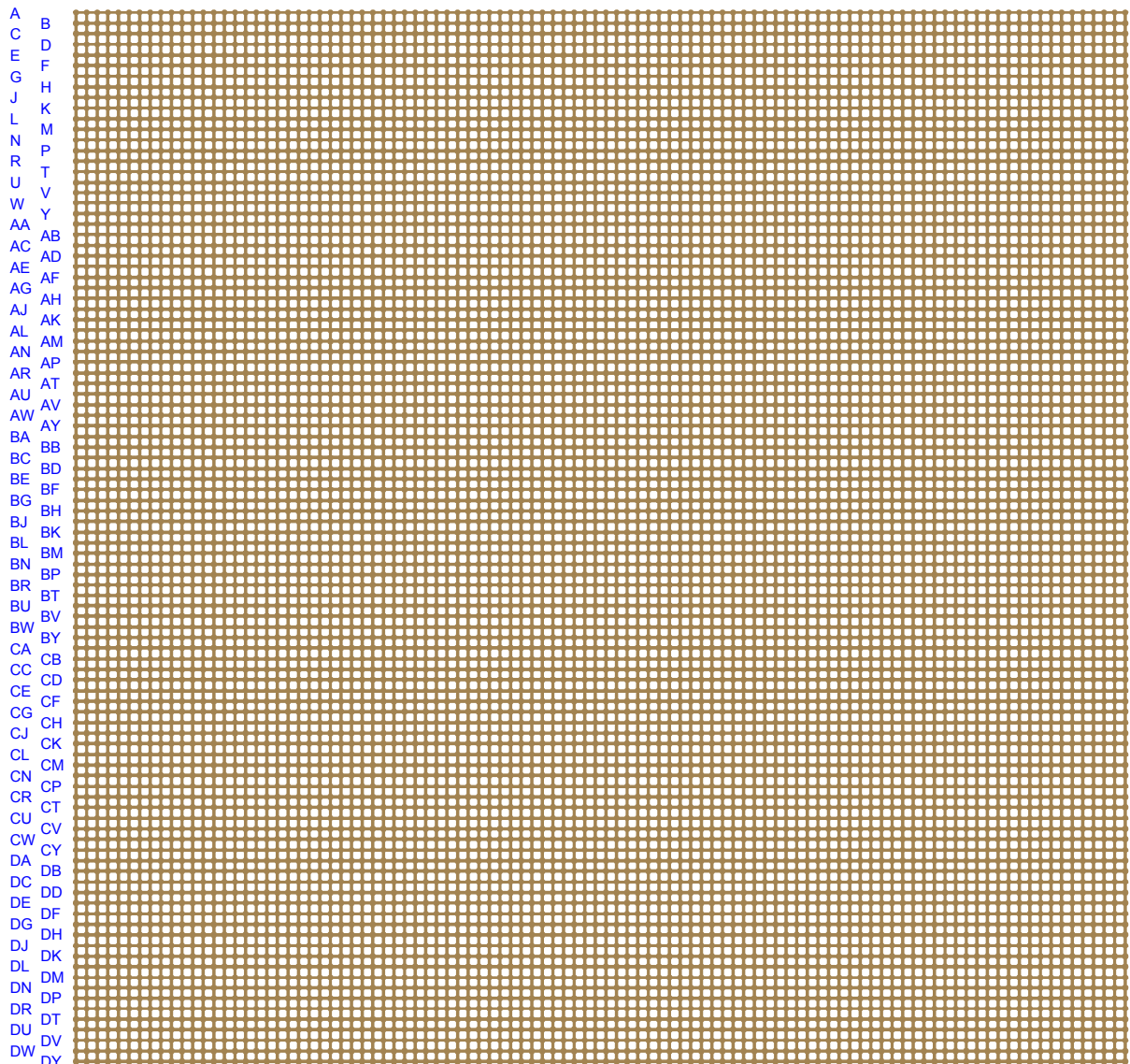

DETAIL A

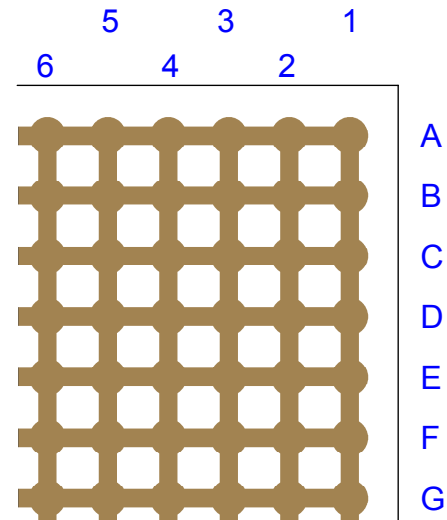

ALL BALLS
CONNECTED

Notes:

- 1) PCB BOARD DIMENSIONS ARE PRESENTED ONLY AS A GUIDELINE. DESIGNERS SHOULD USE THEIR OWN EXPERIENCE WHEN DESIGNING PCB.
- 2) PCB Cu BALL PAD DIAMETER 0.356mm (14 MIL).
- 3) PCB DAISY CHAIN TRACING LINE WIDTH 0.152mm (6 MIL).
- 4) SMD (SOLDER MASK DEFINED) PAD OPENING: 0.254mm (10 MIL).

TopLine®			
TITLE		LBGA1000T.5-BUS ALL PADS SHORTED	
SCALE	SIZE	DRAWING NO.	REV
1.4:1	A	559901	A
DO NOT SCALE DRAWING			SHEET 2 OF 3

BOTTOM SIDE (TOP X-RAY VIEW)

1 3 5 7 9 11 13 15 17 19 21 23 25 27 29 31 33 35 37 39 41 43 45 47 49 51 53 55 57 59 61 63 65 67 69 71 73 75 77 79 81 83 85 87 89 91 93 95 97 99
 2 4 6 8 10 12 14 16 18 20 22 24 26 28 30 32 34 36 38 40 42 44 46 48 50 52 54 56 58 60 62 64 66 68 70 72 74 76 78 80 82 84 86 88 90 92 94 96 98 100

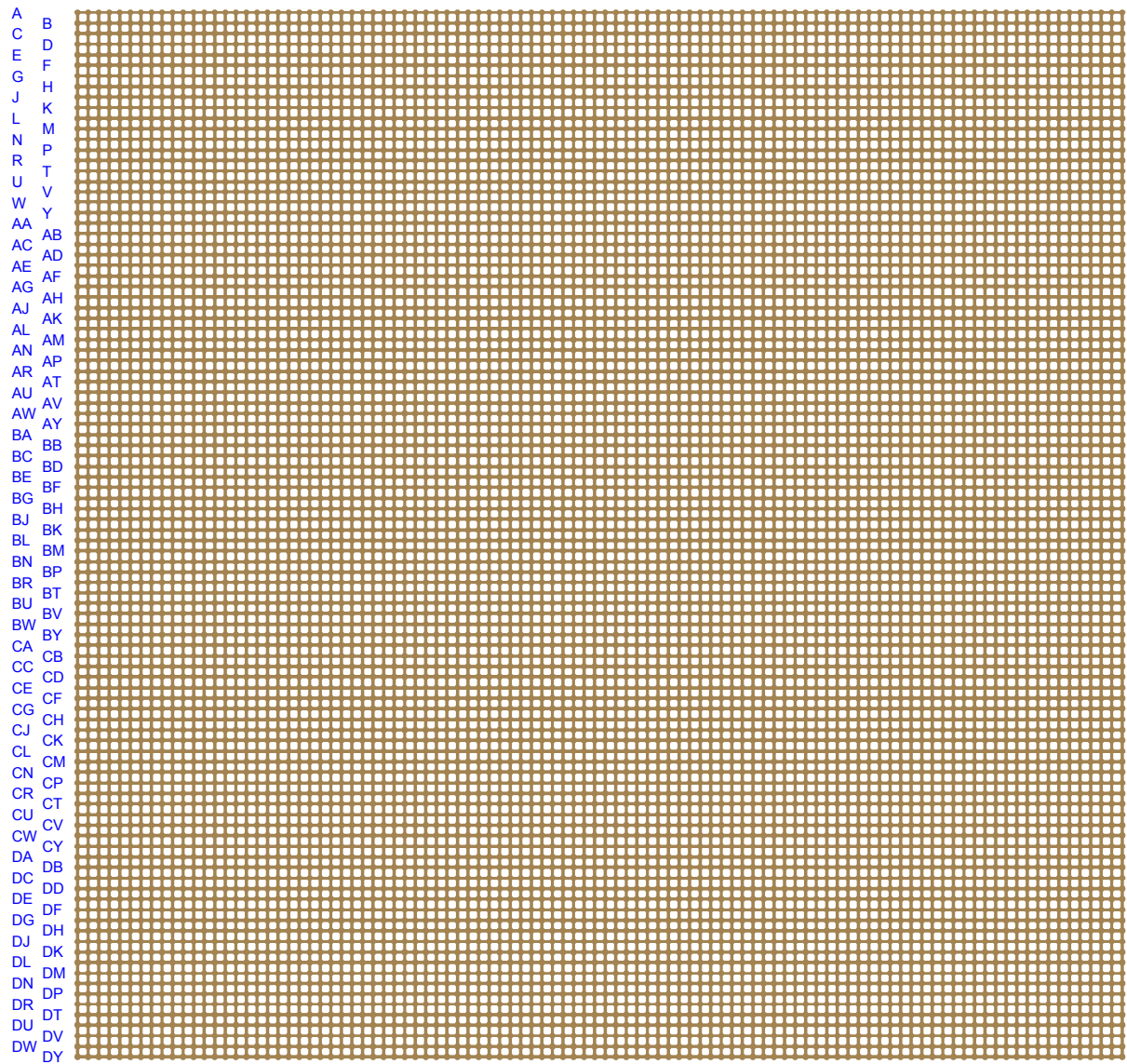

DETAIL B

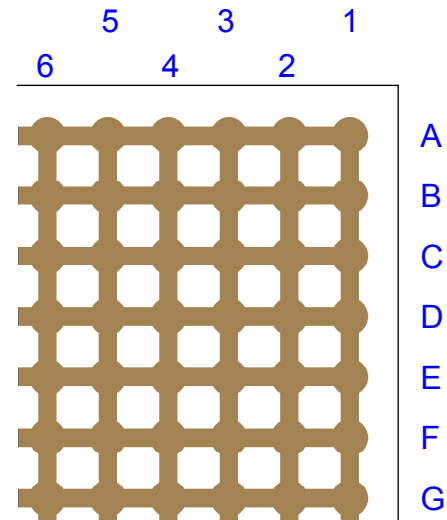

ALL BALLS
CONNECTED

TopLine®			
TITLE		LBGA1000T.5-BUS ALL PADS SHORTED	
SCALE	SIZE	DRAWING NO.	REV
1.4:1	A	559901	A
DO NOT SCALE DRAWING			SHEET 3 OF 3