

**6CHCA J9K**  
**K #K @8**  
**75J #M8CKB**

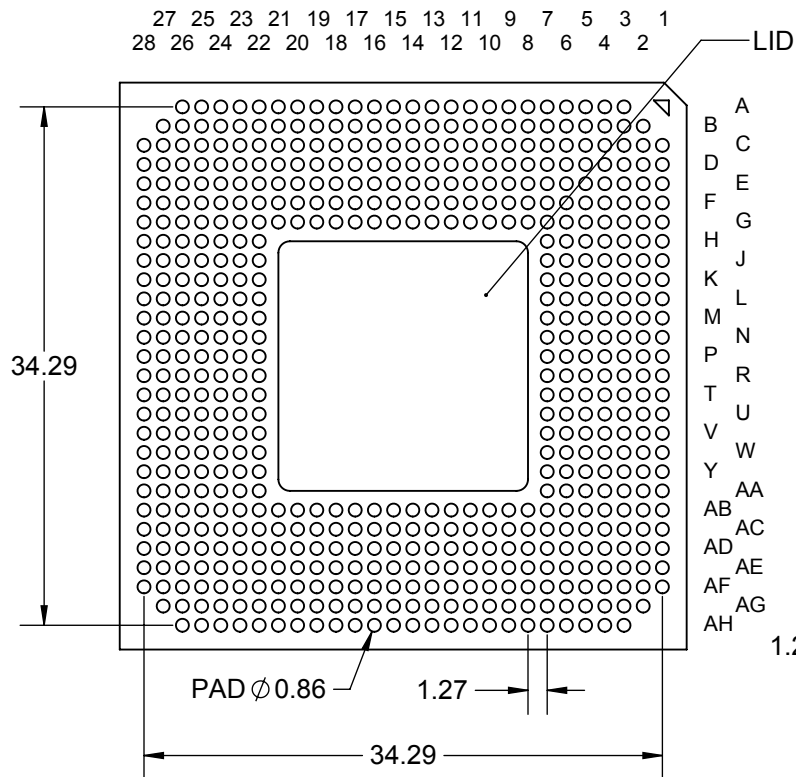

**G89 J9K**

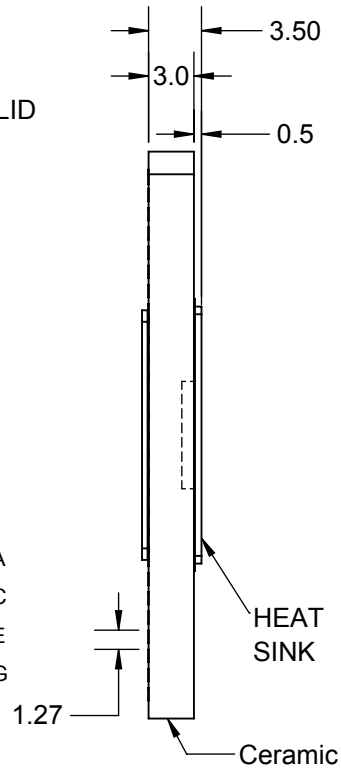

**HCD J9K**  
**K #K <95H GB?**

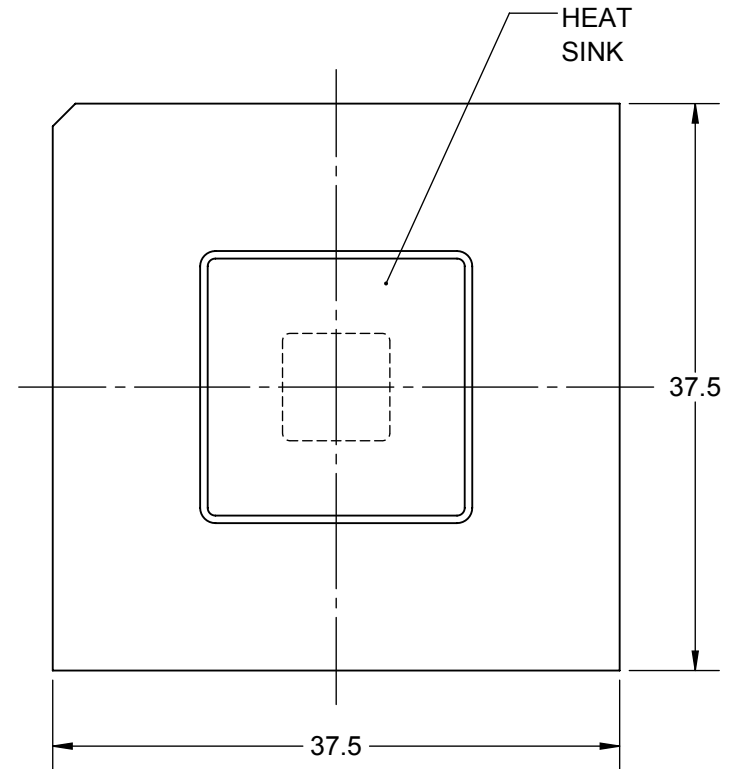

1. PLATING: (ELECTROLESS)  
 Ni: 3.20~12.00 MICRON.  
 Au: 1.52 MICRON MIN.

- Notes: (Unless Otherwise Specified).  
 1) DIMENSIONS ARE MM.  
 2) SHOWN WITHOUT COLUMNS.  
 3) SHOWN WITH LID COVER ATTACHED.

<b>D5FHBI A69F CDHCBG</b>			
<b>D5FHBI A69F</b>	<b>D58</b>	<b>D58 8-5A9H9F</b>	<b>7C @ AB</b>
CLGA576T1.27-28x28	Ni Au	Ø0.87 MM	NONE

APPROVALS	DATE	<b>TopLine®</b>		
DRAWN T. Au	3/30/2020			
ENG M. Hart	3/30/2020	TITLE CCGA576T1.27-28x28 COLUMN GRID ARRAY		
MFG		SCALE 2.5:1	SIZE A	DRAWING NO. 160093
QA				REV A
CUST				
REVISED		DO NOT SCALE DRAWING		SHEET 1 OF 3

85 GM7 < 5 B'D5 HH9FB

7C@ AB'D58LJ@K

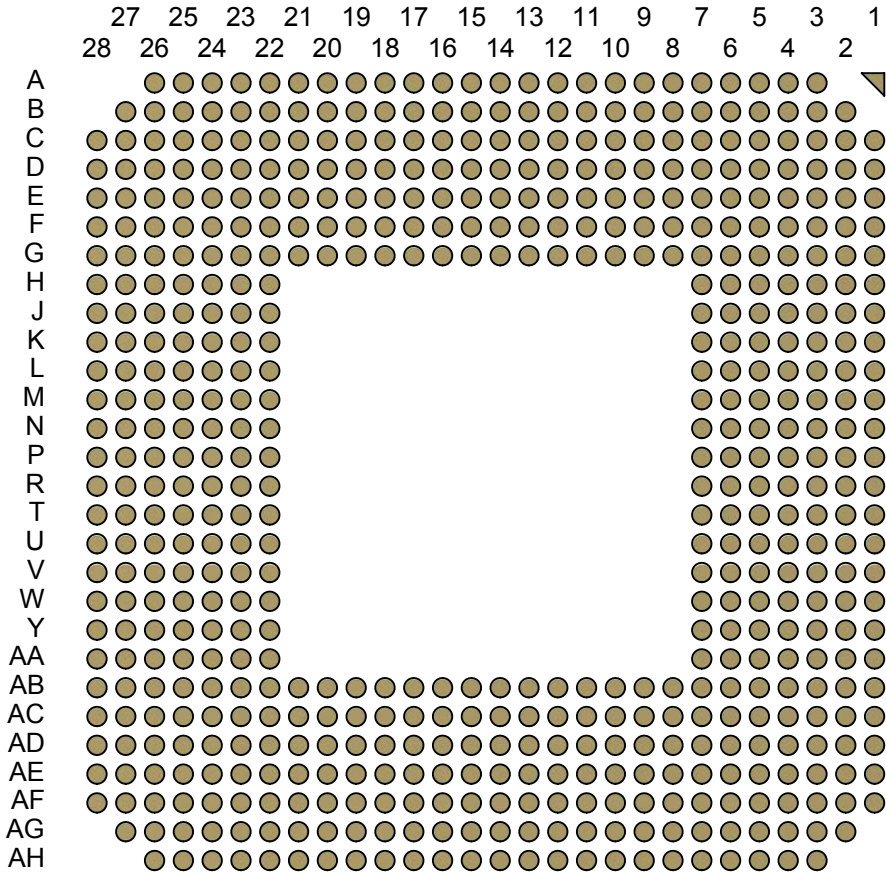

HCD'L!F5 MJ@K

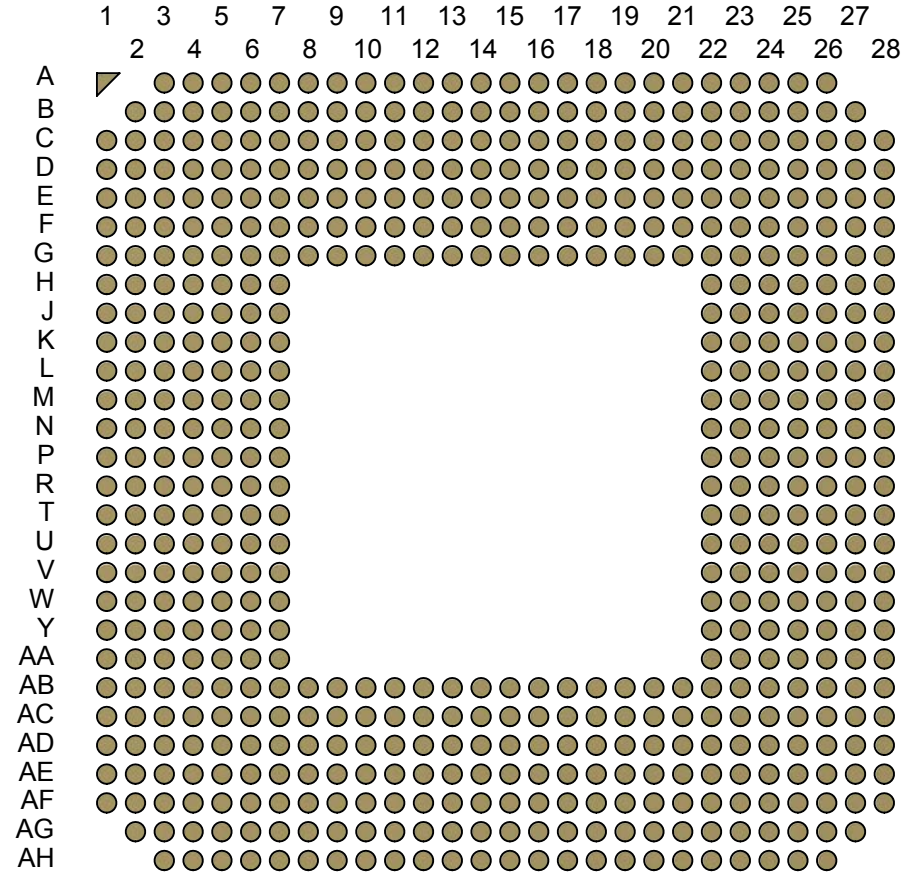

TITLE			
CCGA576T1.27-28x28 COLUMN GRID ARRAY			
SCALE	SIZE	DRAWING NO.	REV
4:1	A	160093	A
DO NOT SCALE DRAWING			SHEET 2 OF 3

AC89 @  
7 @ 5) +\* H%&+!&, I &  
@8 #7 CJ9F '5 HH57 <98

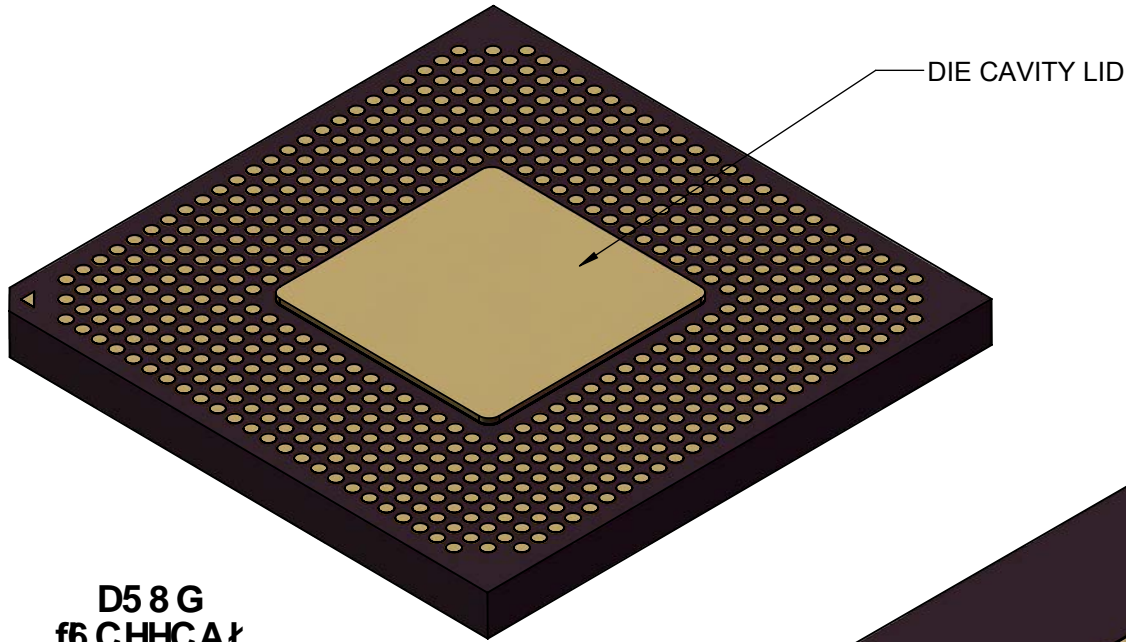

D5 8 G  
f6 CHHCAŁ

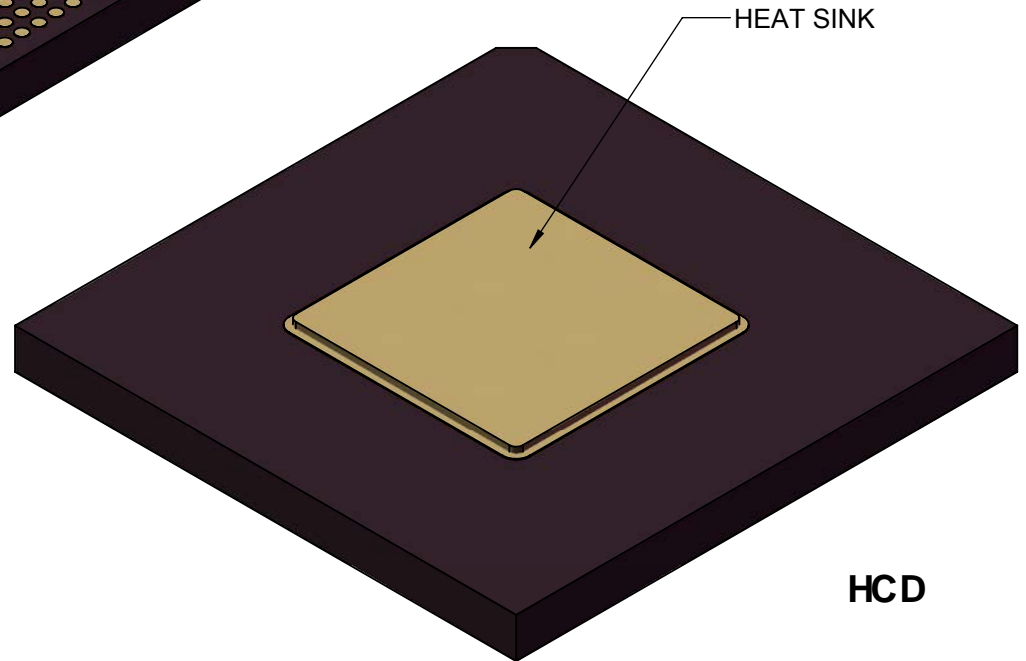

HCD

**TopLine**<sup>®</sup>

TITLE CCGA576T1.27-28x28  
COLUMN GRID ARRAY

SCALE	SIZE	DRAWING NO.	REV
2.5:1	A	160093	A

DO NOT SCALE DRAWING

SHEET 3 OF 3