

HIGH PROFILE

TOP VIEW

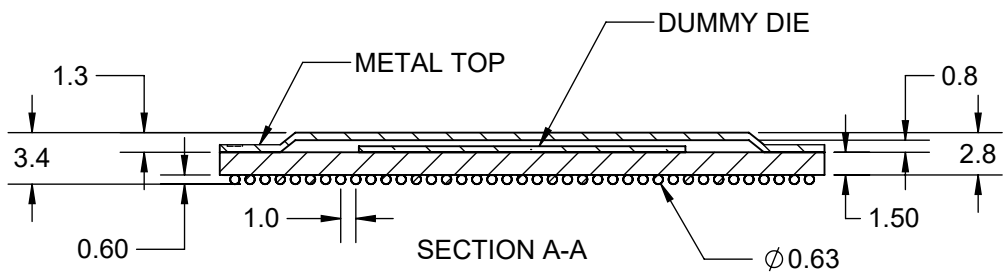

BALL VIEW

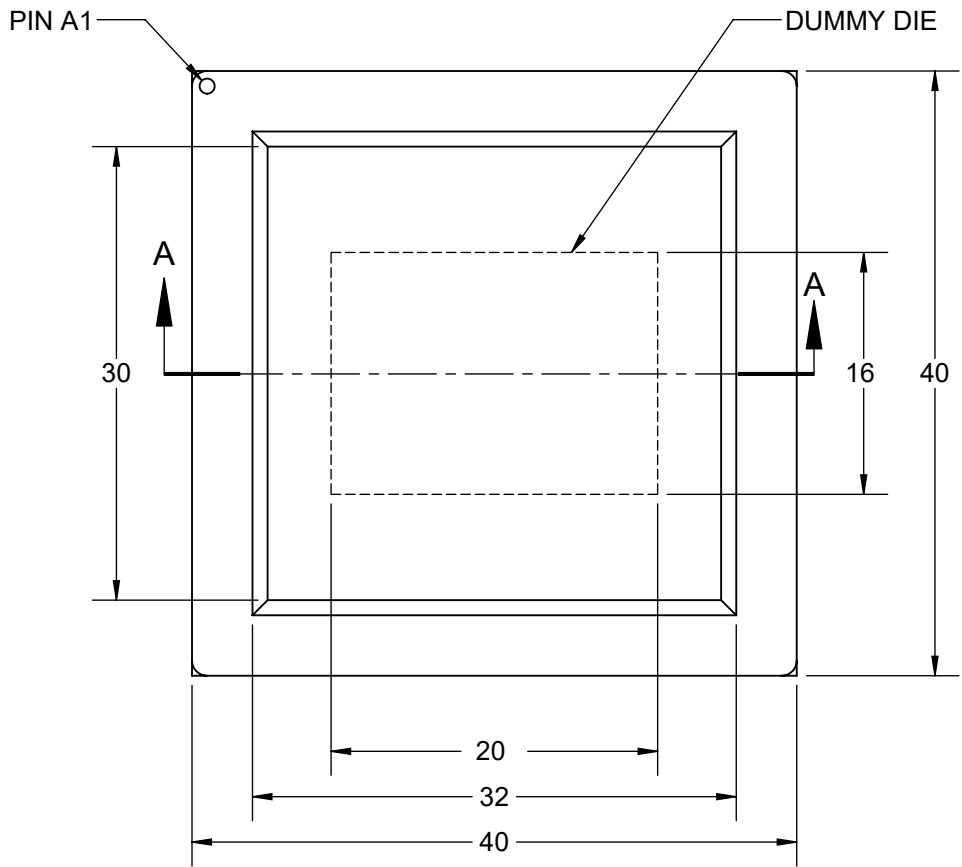
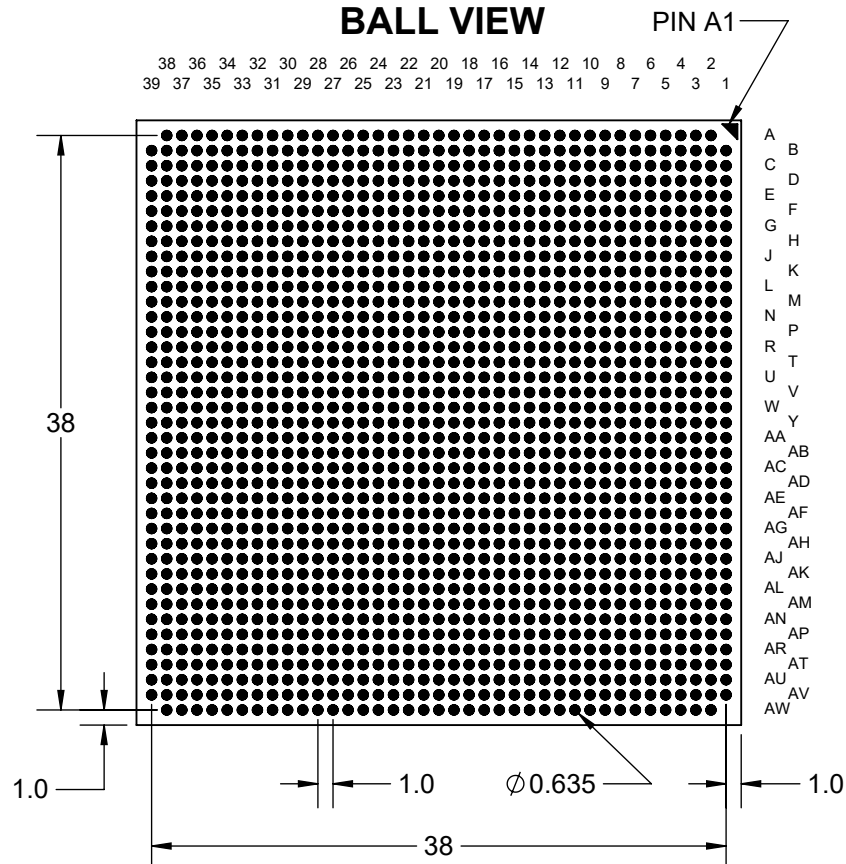

Notes: (Unless Otherwise Specified).

- 1) ALL DIMENSIONS ARE IN MM.
- 2) SOLDER BALL ALLOY: SEE PART NUMBER TABLE.
- 3) BALL DIAMETER (BEFORE REFLOW) 0.635mm.
- 4) SOLDER MASK DEFINED PAD OPENING: 0.508mm [20mil].
- 5) PAD Cu DIAMETER: 0.635mm [25MIL].
- 6) DUMMY DIE. Si (SILICON).
- 7) DAISY CHAIN PATTERN (SEE PAGE 2).
- 8) MSL-3 RECOMMENDED BAKING 24 HOURS @ 125°C TO REMOVE MOISTURE PRIOR TO SOLDERING TO PC BOARD.

| PART NUMBER TABLE | | | | |
|-----------------------|--------------------|------------|------|--------|
| PART NUMBER | BALL METAL | BALL ALLOY | RoHS | Si DIE |
| SBGA1517T1.0C-DC397HD | Sn96.5/Ag3.0/Cu0.5 | SAC305 | YES | YES |
| SBGA1517T1.0-DC397HD | Sn63/Pb37 | Sn63 | NO | YES |

| APPROVALS | DATE | | | | |
|-------------|-----------|--------------------------------------------------|------|-------------|--------------|
| DRAWN T. Au | 3/26/2024 | | | | |
| ENG M. Hart | 3/26/2024 | TITLE SBGA1517T1.0C-DC397HD DAISY CHAIN DUMMY | | | |
| MFG | | SCALE | SIZE | DRAWING NO. | REV |
| QA | | 2:1 | A | 513976 | A |
| CUST | | DO NOT SCALE DRAWING | | | SHEET 1 OF 7 |
| REVISED | | | | | |

BALL VIEW

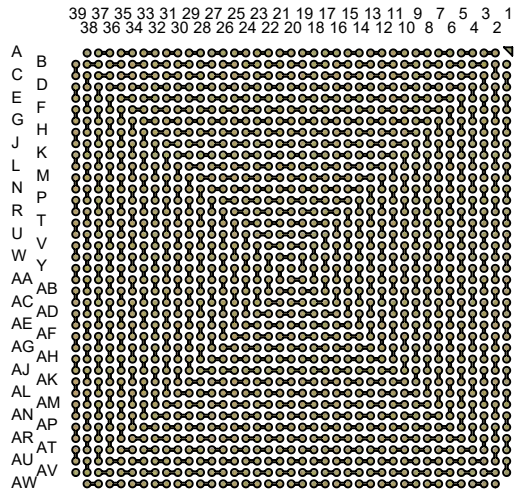

BOTTOM SIDE (TOP X-RAY VIEW)

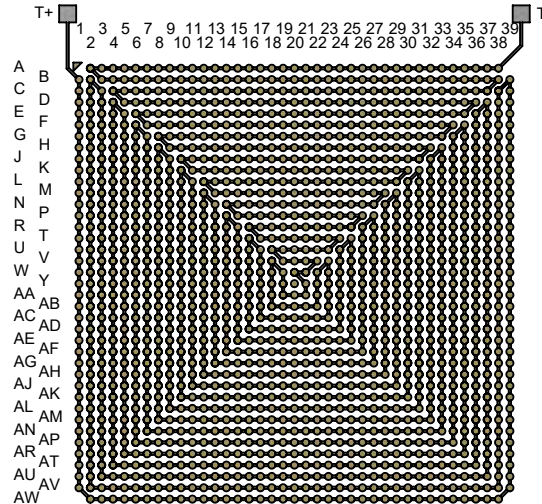
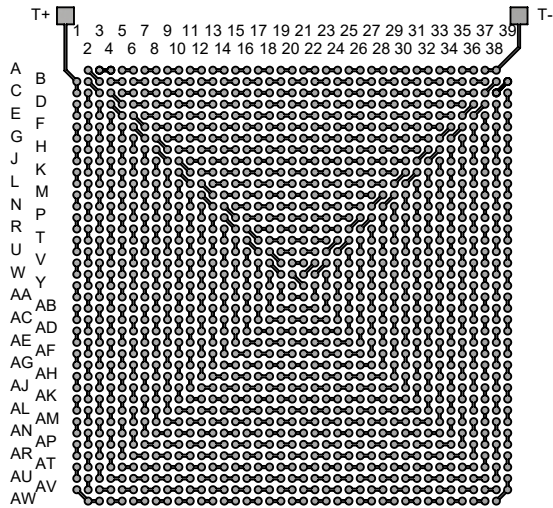
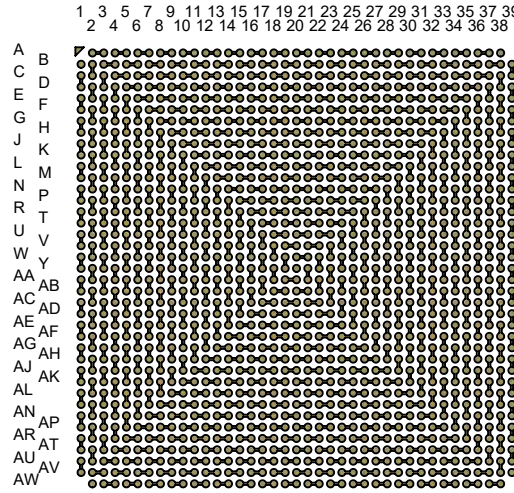

TEST VEHICLE BOARD

Notes:

- PCB BOARD DIMENSIONS ARE PRESENTED ONLY AS A GUIDELINE
- DESIGNERS SHOULD USE THEIR OWN KNOWLEDGE WHEN DESIGNING THE PCB.
- PCB Cu BALL PAD DIAMETER: 0.635mm [25mil].
- PCB DAISY CHAIN TRACING LINE WIDTH: 0.203mm [8mil].
- SMD (SOLDER MASK DEFINED) PAD OPENING: 0.508mm [20mil].

AFTER MOUNTING

| | | | |
|--------------------------------------------------|-----------|-----------------------|--------------|
| TopLine® | | | |
| TITLE SBGA1517T1.0C-DC397HD DAISY CHAIN DUMMY | | | |
| SCALE 2:1 | SIZE A | DRAWING NO. 513976 | REV A |
| DO NOT SCALE DRAWING | | | SHEET 2 OF 7 |

BALL VIEW

39 38 37 36 35 34 33 32 31 30 29 28 27 26 25 24 23 22 21 20 19 18 17 16 15 14 13 12 11 10 9 8 7 6 5 4 3 2 1

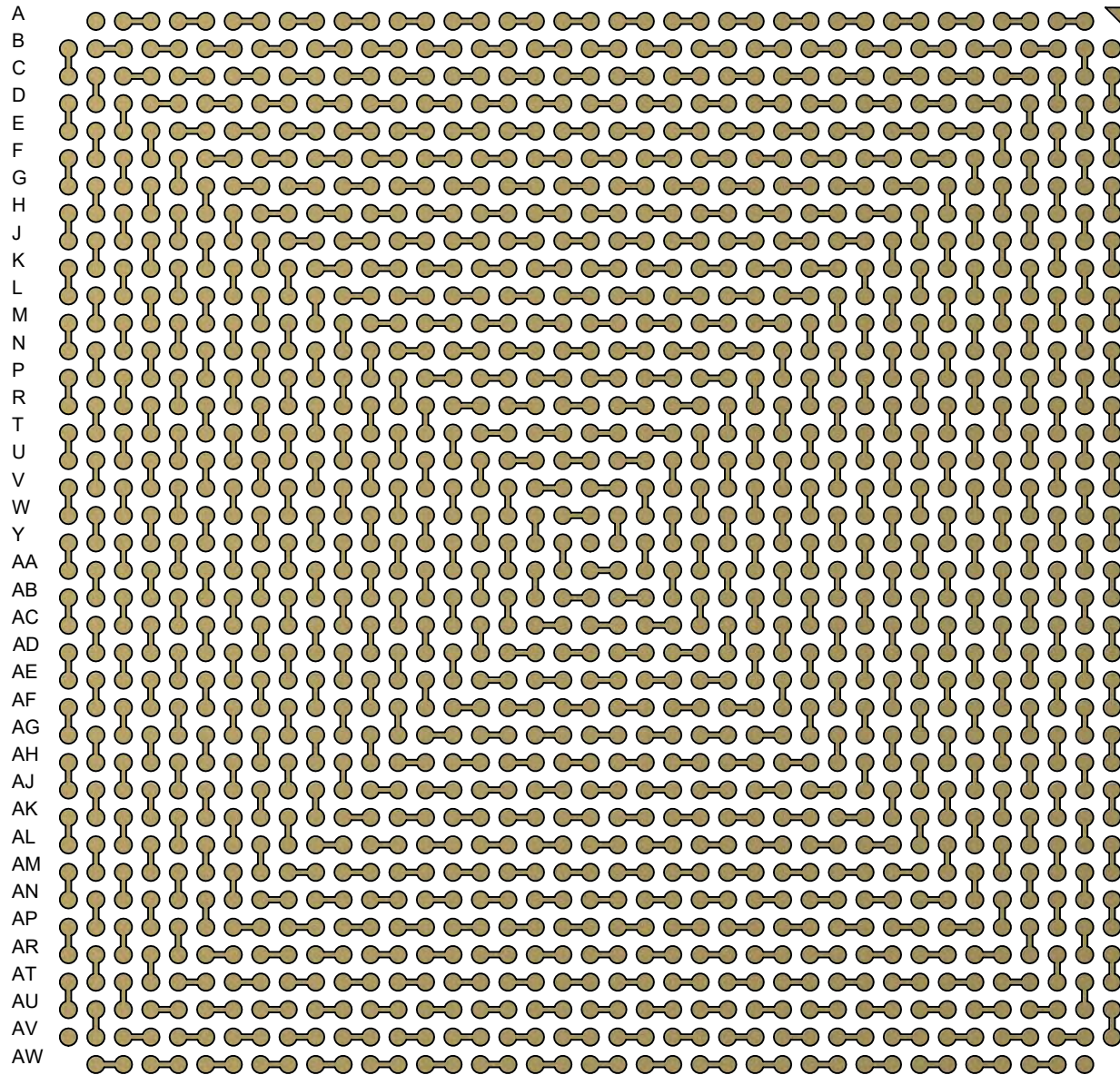

TopLine[®]

TITLE SBGA1517T1.0C-DC397HD
DAISY CHAIN DUMMY

| | | | |
|--------------|-----------|-----------------------|----------|
| SCALE 2:1 | SIZE A | DRAWING NO. 513976 | REV A |
|--------------|-----------|-----------------------|----------|

DO NOT SCALE DRAWING

SHEET 3 OF 7

BOTTOM SIDE (TOP X-RAY VIEW)

1 2 3 4 5 6 7 8 9 10 11 12 13 14 15 16 17 18 19 20 21 22 23 24 25 26 27 28 29 30 31 32 33 34 35 36 37 38 39

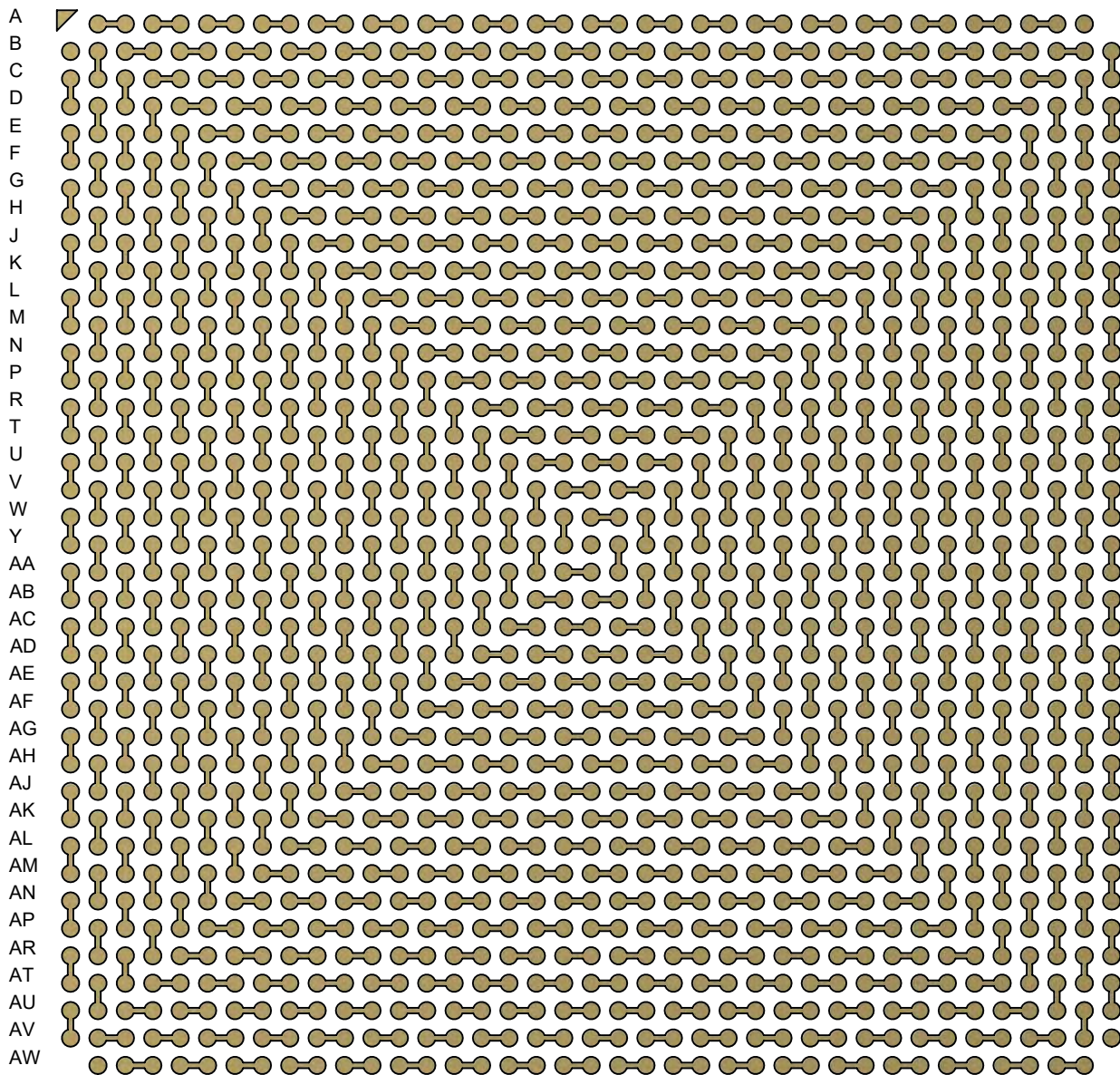

| | | | |
|----------------------|------|--------------------------------------------|--------------|
| TopLine® | | | |
| TITLE | | SBGA1517T1.0C-DC397HD DAISY CHAIN DUMMY | |
| SCALE | SIZE | DRAWING NO. | REV |
| 2:1 | A | 513976 | A |
| DO NOT SCALE DRAWING | | | SHEET 4 OF 7 |

HEAT SPREADER

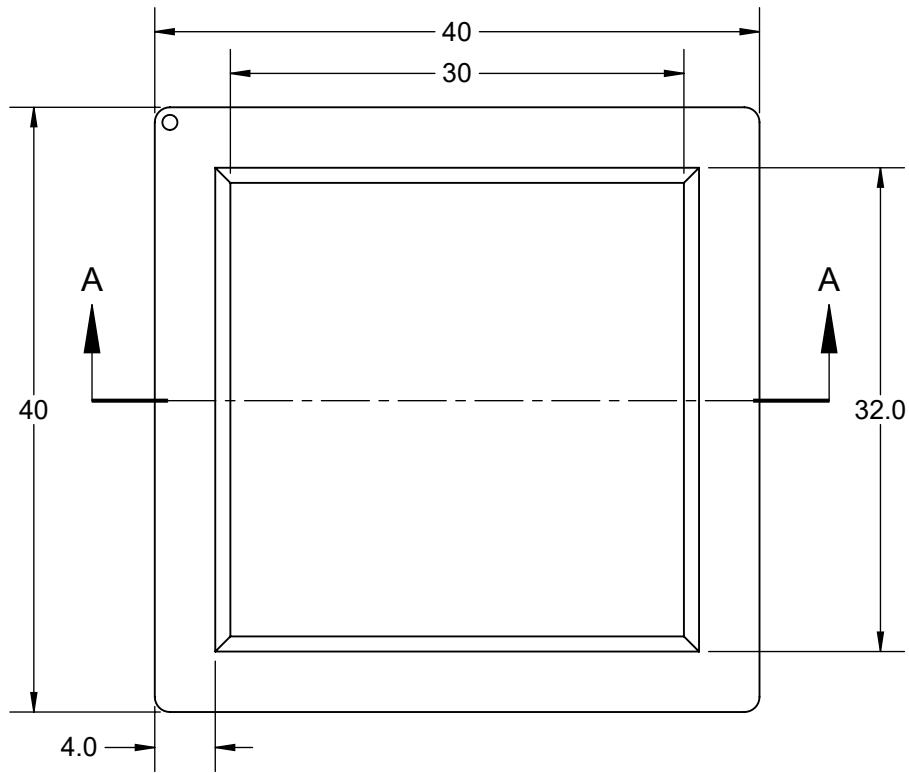

TOP

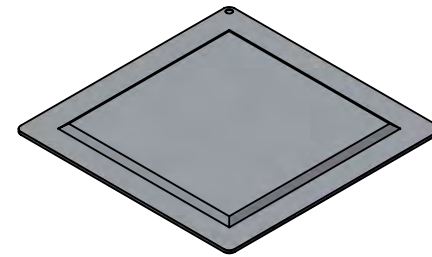

MODEL

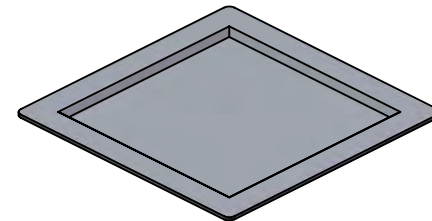

CAVITY

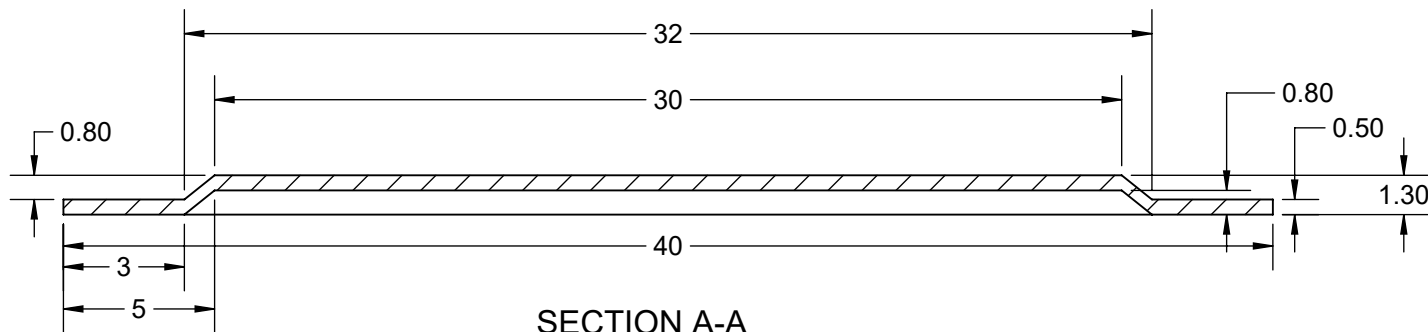

SECTION A-A
SCALE 4 : 1

TopLine[®]

TITLE SBGA1517T1.0C-DC397HD
DAISY CHAIN DUMMY

| | | | |
|--------------|-----------|-----------------------|----------|
| SCALE 3:2 | SIZE A | DRAWING NO. 513976 | REV A |
|--------------|-----------|-----------------------|----------|

DO NOT SCALE DRAWING

SHEET 5 OF 7

MODEL

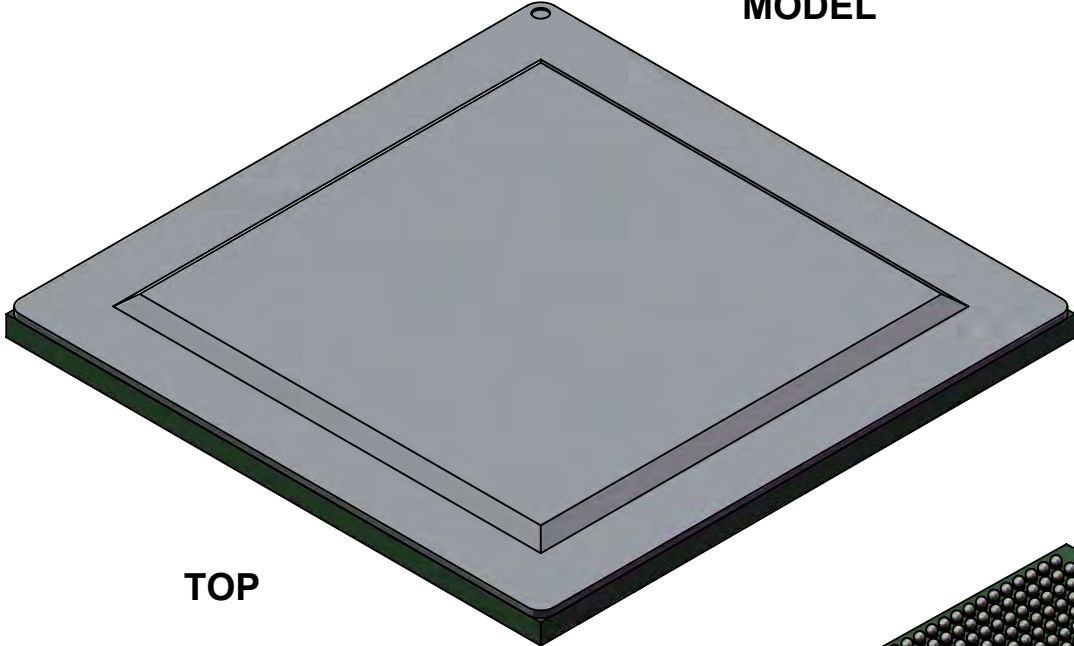

TOP

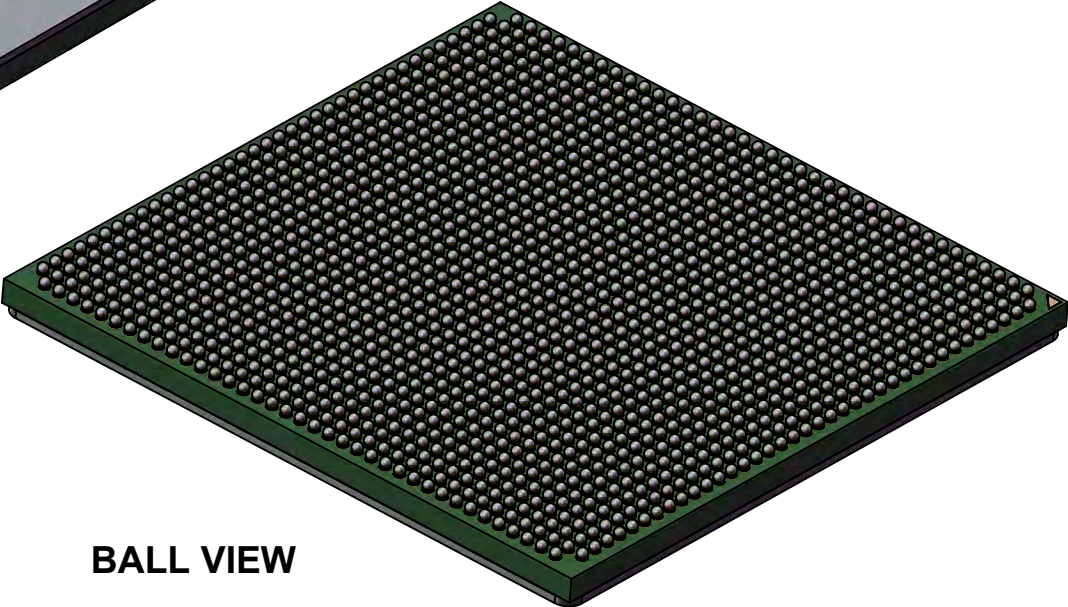

BALL VIEW

TopLine[®]

TITLE SBGA1517T1.0C-DC397HD
DAISY CHAIN DUMMY

| | | | |
|--------------|-----------|-----------------------|----------|
| SCALE 2:1 | SIZE A | DRAWING NO. 513976 | REV A |
|--------------|-----------|-----------------------|----------|

DO NOT SCALE DRAWING SHEET 6 OF 7

**BOTTOM SOLDERMASK
(RIGHT READING)**

39 38 37 36 35 34 33 32 31 30 29 28 27 26 25 24 23 22 21 20 19 18 17 16 15 14 13 12 11 10 9 8 7 6 5 4 3 2 1

A
B
C
D
E
F
G
H
J
K
L
M
N
P
R
T
U
V
W
Y
AA
AB
AC
AD
AE
AF
AG
AH
AJ
AK
AL
AM
AN
AP
AR
AT
AU
AV
AW

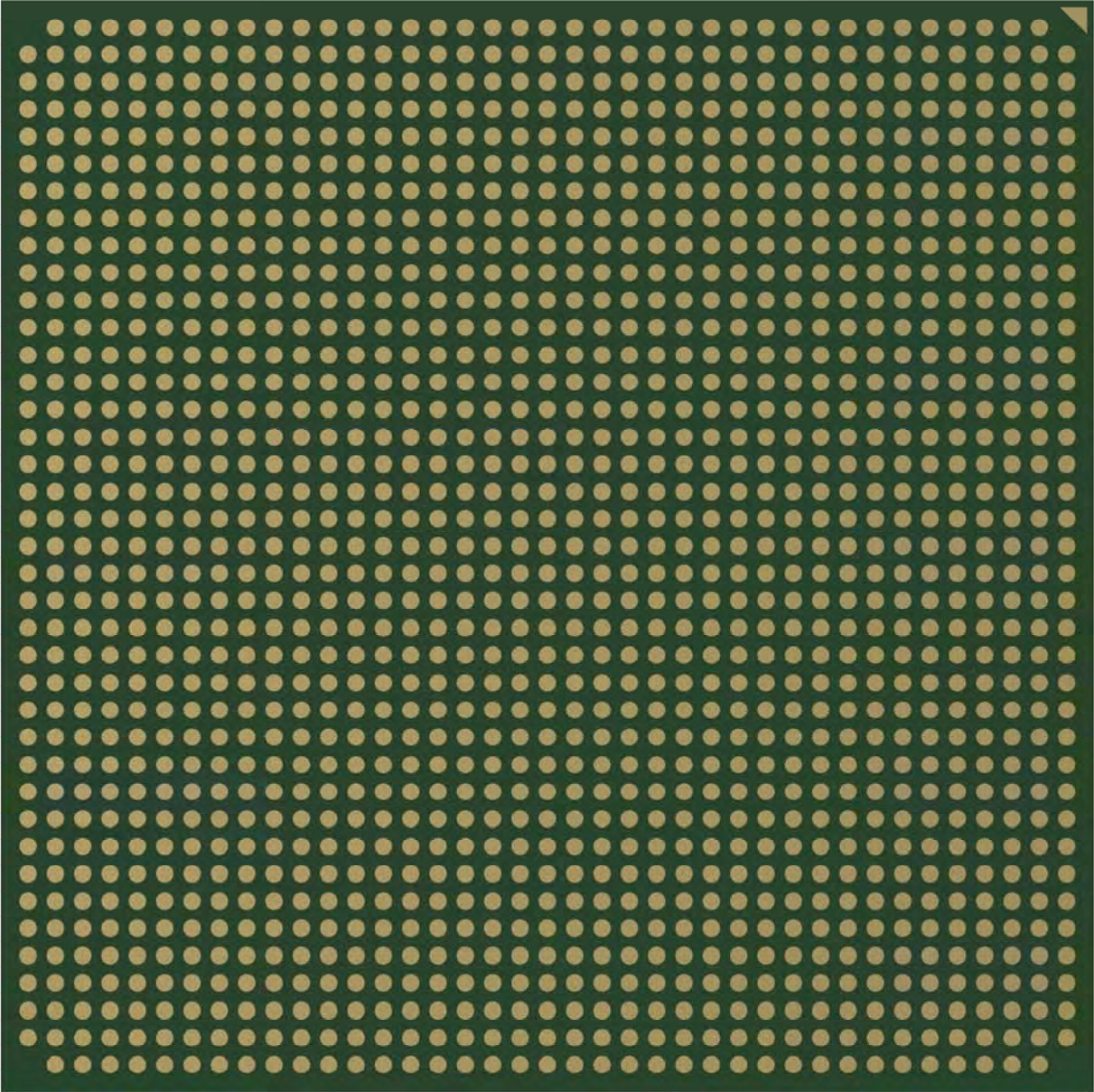

| | | | |
|--------------------------------------------------|-----------|-----------------------|--------------|
| TopLine® | | | |
| TITLE SBGA1517T1.0C-DC397HD DAISY CHAIN DUMMY | | | |
| SCALE 2:1 | SIZE A | DRAWING NO. 513976 | REV A |
| DO NOT SCALE DRAWING | | | SHEET 7 OF 7 |