

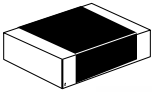









SERIES	DESCRIPTION	VIEW	WEBCODE	PAGE
SC	Ceramic Chip Capacitor			7
SD	Molded Tantalum		XD1	8
SE	Aluminum Capacitor			9
SR	Resistor Chip			10
SRM	Melf Resistor		XD1	11
SRA	Resistor Array			12
SI	Inductor		XD1	13

SERIES	DESCRIPTION	VIEW	WEBCODE	PAGE
SOT	Transistor		XD1	14
DPAK	Power Discrete		XD1	15
SOD, SM	Melf Diode/Rectifier		XD1	16
SMA~SMC	Rectangular Diode/Rectifier		XD1	17

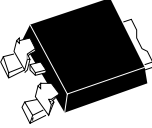

CERAMIC CHIP CAPACITOR

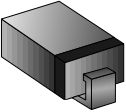

DUMMY COMPONENT ORDERING INFORMATION

CHIP SIZE		TAPE INFO		BULK CHIP CASE		4" (100mm) Tape & Reel Part Number		7" (180mm) Tape & Reel Part Number		13" (330mm) Tape & Reel Part Number	
Inch	Metric	WIDTH	PITCH	XD1	QTY	XM1	QTY	XD1	QTY	XD1	QTY
PAPER TAPE											
0201	0603	8mm	2mm	-	-	SC0201P4A	500	SC0201P7A	15,000	-	-
0402	1005	8mm	2mm	SC0402F	50,000	SC0402P4A	500	SC0402P7A	10,000	SC0402P13A	50,000
0603	1608	8mm	4mm	SC0603F	15,000	SC0603P4A	500	SC0603P7A	4000	SC0603P13A	10,000
0805	2012	8mm	4mm	SC0805F-.6	10,000	SC0805P4A	500	SC0805P7A	4000	SC0805P13A	10,000
0805	2012	8mm	4mm	SC0805F-1.25	5000						
1206	3216	8mm	4mm	SC1206F	4000	SC1206P4A	500	SC1206P7A	4000	SC1206P13A	10,000
PLASTIC TAPE											
0805	2012	8mm	4mm	-	-	SC0805E4A	500	SC0805E7A	3000	SC0805E13A	10,000
1206	3216	8mm	4mm	-	-	SC1206E4A	500	SC1206E7A	3000	SC1206E13A	10,000
1210	3225	8mm	4mm	-	-	SC1210E4A	500	SC1210E7A	3000	SC1210E13A	10,000
1812	4532	12mm	8mm	-	-	SC1812E4A	100	SC1812E7A	1000	SC1812E13A	4000
2225	5664	12mm	8mm	-	-	SC2225E4A	100	SC2225E7A	1000	SC2225E13A	4000
LEAD-FREE  Sn100											
0402	1005	8mm	4mm	-	-	SC0402E4A-TIN	500	SC0402E7A-TIN	5000	-	-
0603	1608	8mm	4mm	-	-	SC0603E4A-TIN	500	SC0603E7A-TIN	4000	-	-
0805	2012	8mm	4mm	-	-	SC0805E4A-TIN	500	SC0805E7A-TIN	4000	-	-
1206	3216	8mm	4mm	-	-	SC1206E4A-TIN	500	SC1206E7A-TIN	4000	-	-
1210	3225	8mm	4mm	-	-	SC1210E4A-TIN	500	SC1210E7A-TIN	4000	-	-
1812	4532	12mm	8mm	-	-	SC1812E4A-TIN	100	SC1812E7A-TIN	1000	-	-

DIMENSION TOLERANCE L x W

0201 ± 0.03mm	0805 ± 0.15mm
0402 ± 0.05mm	1206 ± 0.15mm
0603 ± 0.1mm	1210 ± 0.30mm

HEIGHT (H)

0201	0.3mm ± 0.03	0805	0.6~1.25mm
0402	0.5mm ± 0.1	1206	0.6~1.25mm
0603	0.8mm ± 0.1	1210	1.25~1.5mm

**I
N
F
O** Ceramic chip capacitors are standard with Sn/Pb plated Nickel-Barrier terminations. Other sizes such as 0504, 1805, 1806, 2220 are available on special order. Also available lead-free with Sn 100% tin terminations. Nomenclature: The chip size code is the component's LxW dimensions. Example: 0805 = .08" x .05". Chip size may also be expressed in metric code. Example: 2012 = 2.0mm x 1.2mm.



TANTALUM CAPACITOR MOLDED CASE

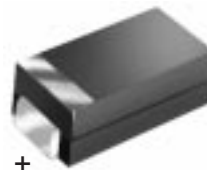

DUMMY COMPONENT ORDERING INFORMATION

CHIP SIZE		TAPE INFO		 Bulk Part Number	4" (100mm) Tape & Reel Part Number		7" (180mm) Tape & Reel Part Number		
METRIC	CODE	WIDTH	PITCH		QTY	QTY	QTY	QTY	
3216	A	8mm	4mm	SD3216X-100	100	SD3216E4A	250	SD3216E7A	2000
3528	B	8mm	4mm	SD3528X-100	100	SD3528E4A	250	SD3528E7A	2000
6032	C	12mm	8mm	SD6032X-50	50	SD6032E4A	100	SD6032E7A	500
7343	D	12mm	8mm	SD7343X-50	50	SD7343E4A	100	SD7343E7A	500

DIMENSIONS			
CASE	LENGTH	WIDTH	HEIGHT
A	3.2mm	1.6mm	1.6mm
B	3.5mm	2.8mm	1.9mm
C	6.0mm	3.2mm	2.5mm
D	7.3mm	4.3mm	2.8mm

**I
N
F
O** Molded tantalum capacitors are available in four standard footprints. All sizes meet EIA/IECQ dimensions. The positive (+) terminal is oriented away from the sprocket holes.
Nomenclature: The metric code specifies the LxW dimensions in millimeters. Example 3528 = 3.5mm x 2.8mm
Standard plating is Sn/Pb.

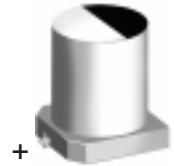

DUMMY COMPONENT ORDERING INFORMATION

CASE DIAMETER	MAXIMUM HEIGHT	TAPE INFO		7" (180mm)  Tape & Reel Part Number		13" (330mm)  Tape & Reel Part Number	
		WIDTH	PITCH	XM1	QTY	XD1	QTY
3mm	5.5mm	12mm	8mm	-	-	SE3E13A	2000
4mm	5.5mm	12mm	8mm	SE4E7A	100	SE4E13A	2000
5mm	5.5mm	12mm	12mm	SE5E7A	100	SE5E13A	1000
6.3mm	5.5mm	16mm	12mm	SE6E7A	100	SE6E13A	1000
8mm	6.0mm	16mm	12mm	-	-	SE8E13A	1000
8mm	10mm	24mm	16mm	-	-	SE9E13A	500
10mm	10mm	24mm	16mm	-	-	SE10E13A	500
12.5mm	14mm	32mm	24mm	-	-	SE12E13A	200/250
12.5mm	17mm	32mm	24mm	-	-	SE13E13A	150/200
16mm	17mm	44mm	28mm	-	-	SE16E13A	125/150
16mm	22mm	44mm	28mm	-	-	SE17E13A	75/100
18mm	22mm	44mm	32mm	-	-	SE18E13A	75
18mm	17mm	44mm	32mm	-	-	SE19E13A	75/100

Aluminum electrolytic capacitors are available in 13 case sizes. Aluminum capacitors are polarized devices and require proper orientation during placement. The negative terminal (black mark on top of component) faces the sprocket holes on the carrier tape.

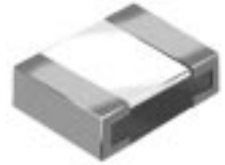

DUMMY COMPONENT ORDERING INFORMATION

CHIP SIZE		TAPE INFO		BULK CHIP CASE PART NUMBER		4" (100mm) Tape & Reel Part Number		7" (180mm) Tape & Reel Part Number		13" (330mm) Tape & Reel Part Number	
Inch	Metric	WIDTH	PITCH	XD1	QTY	XM1	QTY	XD1	QTY	XD1	QTY
PAPER TAPE											
0201	0603	8mm	2mm	-	-	SR0201P4A	1000	SR0201P7A	10,000	-	-
0402	1005	8mm	2mm	SR0402F	50,000	SR0402P4A	1000	SR0402P7A	10,000	SR0402P13A	50,000
0603	1608	8mm	4mm	SR0603F	25,000	SR0603P4A	1000	SR0603P7A	5,000	SR0603P13A	10,000
0805	2012	8mm	4mm	SR0805F	10,000	SR0805P4A	1000	SR0805P7A	5,000	SR0805P13A	10,000
1206	3216	8mm	4mm	SR1206F	5,000	SR1206P4A	1000	SR1206P7A	5,000	SR1206P13A	10,000
1210	3225	8mm	4mm	-	-	SR1210P4A	1000	SR1210P7A	5,000	SR1210P13A	10,000
PLASTIC TAPE											
1210	3225	8mm	4mm	-	-	SR1210E4A	1000	SR1210E7A	4,000	SR1210E13A	10,000
2010	5025	12mm	4mm	-	-	SR2010E4A	250	SR2010E7A	4,000	SR2010E13A	10,000
2512	6332	12mm	8mm	-	-	SR2512E4A	250	SR2512E7A	2,000	SR2512E13A	4,000
ZERO OHM											
0402	1005	8mm	2mm	SR0402F-ZERO	-	-	-	SR0402P7A-ZERO	10,000	-	-
0603	1608	8mm	4mm	SR0603F-ZERO	-	-	-	SR0603P7A-ZERO	5,000	-	-
0805	2012	8mm	4mm	SR0805F-ZERO	-	-	-	SR0805P7A-ZERO	5,000	-	-
1206	3216	8mm	4mm	SR1206F-ZERO	-	-	-	SR1206P7A-ZERO	5,000	-	-
LEAD FREE  Sn100											
0402	1005	8mm	2mm	SR0402F-TIN	-	SR0402P4A-TIN	1000	SR0402P7A-TIN	10,000	-	-
0603	1608	8mm	4mm	SR0603F-TIN	-	SR0603P4A-TIN	1000	SR0603P7A-TIN	5,000	-	-

DIMENSION TOLERANCE

0402 ± 0.05mm
0603 ~ 2512 ± 0.15mm

HEIGHT (H)

0201	0.23mm ± 0.03	0805	0.55mm ± 0.1
0402	0.35mm ± 0.05	1206	0.55mm ± 0.1
0603	0.45mm ± 0.10	1210	0.55mm ± 0.15

NOTE Resistor chips are available in seven standard sizes. Bulk Feeder cassettes are for placement by high-speed chip shooters. Zero ohm jumpers available for continuity checking. Also available Lead Free Sn100% Tin terminations. Nomenclature: The chip size code approximates the LxW dimensions in inches. Example: 0805 = .08" x .05".



DUMMY COMPONENT ORDERING INFORMATION

SIZE CODE		SIZE LENGTH X DIA.	TAPE INFO		4" (100mm) Tape & Reel Part Number		7" (180mm) Tape & Reel Part Number	
INCH	NAME		WIDTH	PITCH	XM1	QTY	XD1	QTY
PLASTIC TAPE								
0604		1.6 x 1.0mm	8mm	4mm	SRM0604E4A	500	SRM0604E7P	3000
0805	Micro	2.2 x 1.1 mm	8mm	4mm	SRM0805E4A	500	SRM0805E7P	3000
1206	Mini	3.2 x 1.6mm	8mm	4mm	SRM1206E4A	500	SRM1206E7P	3000
1406	Mini	3.5 x 1.4mm	8mm	4mm	SRM1406E4A	500	SRM1406E7P	3000
2308	MELF	5.9 x 2.2mm	12mm	4mm	SRM2308E4A	250	SRM2308E7P	1500
LEAD FREE  Sn100								
0805	Micro	2.2 x 1.1	8mm	4mm	SRM0805E4A-TIN	500	SRM0805E7A-TIN	3000
1206	Mini	3.2 x 1.6	8mm	4mm	SRM1206E4A-TIN	500	SRM1206E7A-TIN	3000
2308	MELF	5.9 x 2.2	12mm	4mm	SRM2308E4A-TIN	250	SRM2308E7A-TIN	2000
ZERO OHM								
0805	Micro	2.2 x 1.1	8mm	4mm	SRM0805E4A-ZERO	500	SRM0805E7A-ZERO	3000
1206	Mini	3.2 x 1.6	8mm	4mm	SRM1206E4A-ZERO	500	SRM1206E7A-ZERO	3000
2308	MELF	5.9 x 2.2	12mm	4mm	SRM2308E4A-ZERO	250	SRM2308E7A-ZERO	2000



DUMMY COMPONENT ORDERING INFORMATION

INDIVIDUAL CHIP SIZE	LEAD INFO		TAPE INFO		4" (100mm) Tape & Reel Part Number		7" (180mm) Tape & Reel Part Number	
	NBR	PITCH	WIDTH	PITCH	XM1	Q _{TY}	XD1	Q _{TY}
0603 x 4	8	0.8mm	8mm	4mm	SRA0603X4P4A	500	SRA0603X4P7A	5000
0603 x 8	16	0.8mm	12mm	4mm	-		SRA0603X8E7A	4000
0805 x 4	8	1.27mm	12mm	4mm	-		SRA0805X4P7A	4000
0805 x 8	16	1.27mm	16mm	4mm	-		SRA0805X8E7A	4000
1206 x 4	8	1.27mm	12mm	8mm	SRA1206X4E4A	250	SRA1206X4E7A	2000
1206 x 8	16	1.27mm	16mm	8mm	-		SRA1206X8E7A	2000

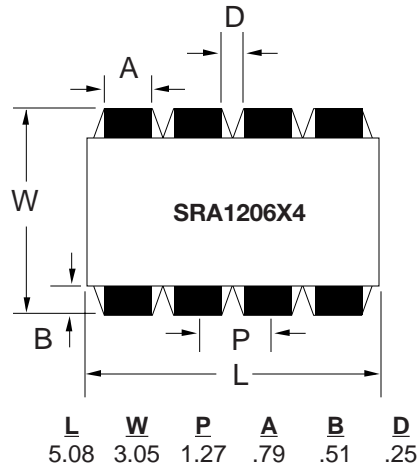
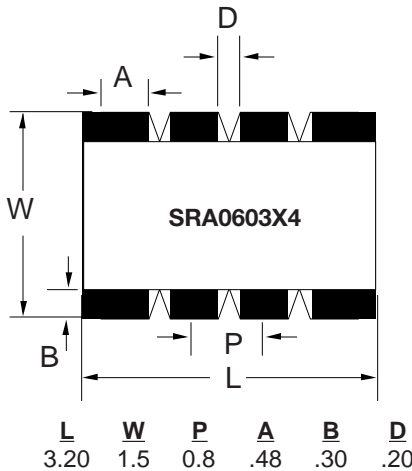

Dimensions in millimeter (mm).



MOLDED CASE



MULTILAYER INDUCTOR

DUMMY COMPONENT ORDERING INFORMATION

CHIP SIZE MAX		HEIGHT	TAPE INFO		4" (100mm) Tape & Reel Part Number		7" (180mm) Tape & Reel Part Number	
INCH	METRIC		WIDTH	PITCH	XM1	QTY	XD1	QTY
MULTILAYER INDUCTOR								
0603	1608	0.8mm	8mm	4mm	SI0603E4A	250	SI0603E7A	4000
0805	2012	1.25mm	8mm	4mm	SI0805E4A	250	SI0805E7A	4000
1206	3216	1.60mm	8mm	4mm	SI1206E4A	250	SI1206E7A	2000
MOLDED CASE INDUCTOR								
1008	2520	1.8mm	8mm	4mm	SI1008E4A	250	SI1008E7A	2000
1210	3225	2.2mm	8mm	4mm	SI1210E4A	250	SI1210E7A	2000
1812	4532	3.2mm	12mm	8mm	SI1812E4A	100	SI1812E7A	500



2001 Dummy Parts

HOW TO ORDER

PAYMENT TERMS

- Credit Terms (Net 30) for established customers.
- American Express, JCB, Mastercard and VISA accepted.

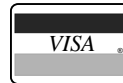

CONFIRMING PURCHASE ORDERS

- Confirming purchase orders are required for all orders over \$500.



MINIMUM PER ORDER

- USA/Canada \$50 minimum. • Export \$1000.

F.O.B. POINT AND SHIPPING

- F.O.B. Garden Grove, California. Please specify preferred method of shipment when placing order.

TopLine™

e-mail sales@topline.tv

www.dummy.tv

11731 Markon Drive, Garden Grove, CA 92841 USA

Toll Free USA/Canada 1-800-776-9888

Tel 1-714-898-3830

Fax 1-714-891-0321

© 2001. TopLine. All Rights Reserved

This catalog, or any parts thereof, must not be reproduced in any form without written permission of TopLine.

Reprint May 2001