

SIDE

TOP VIEW

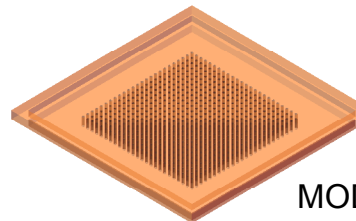
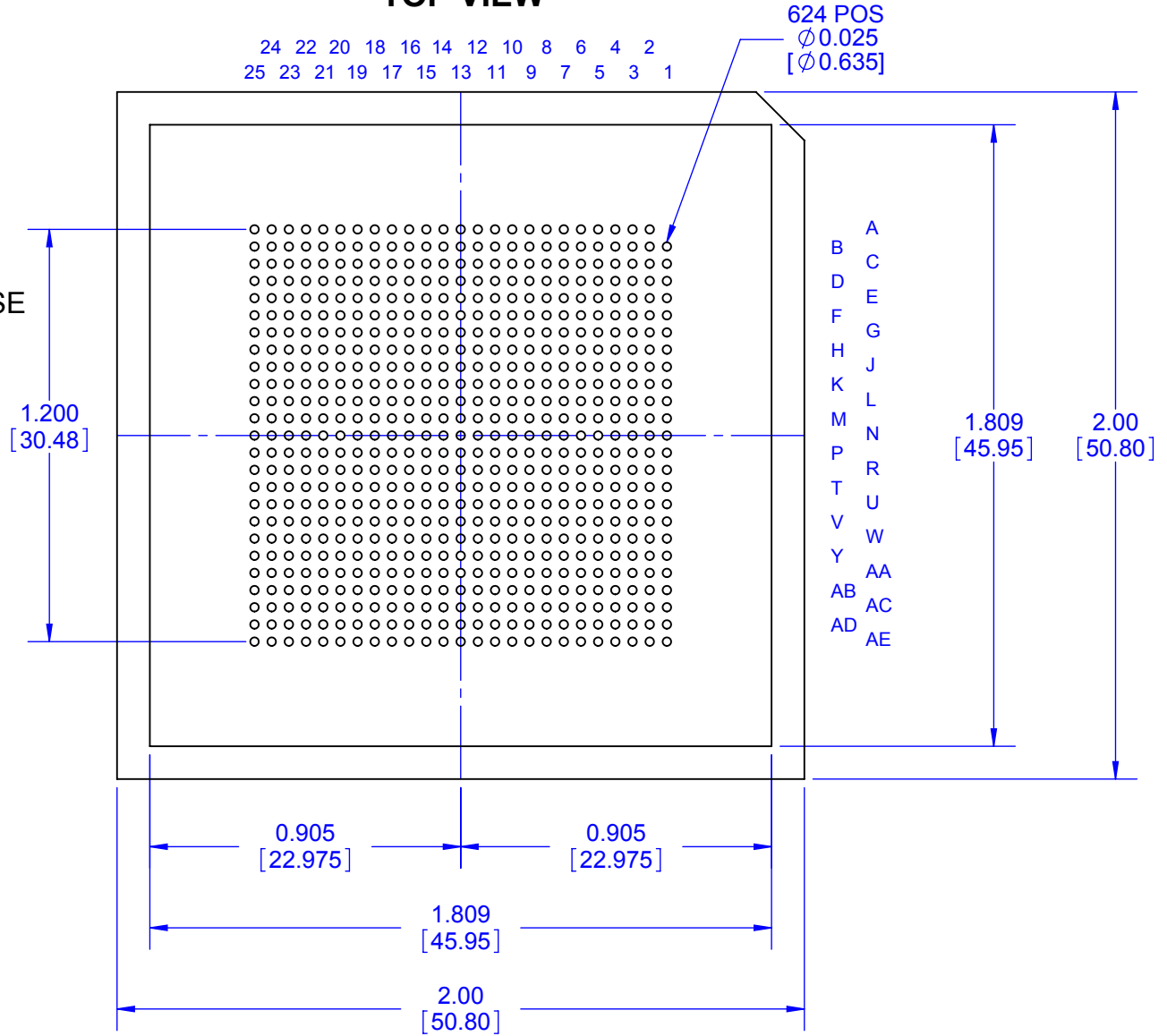
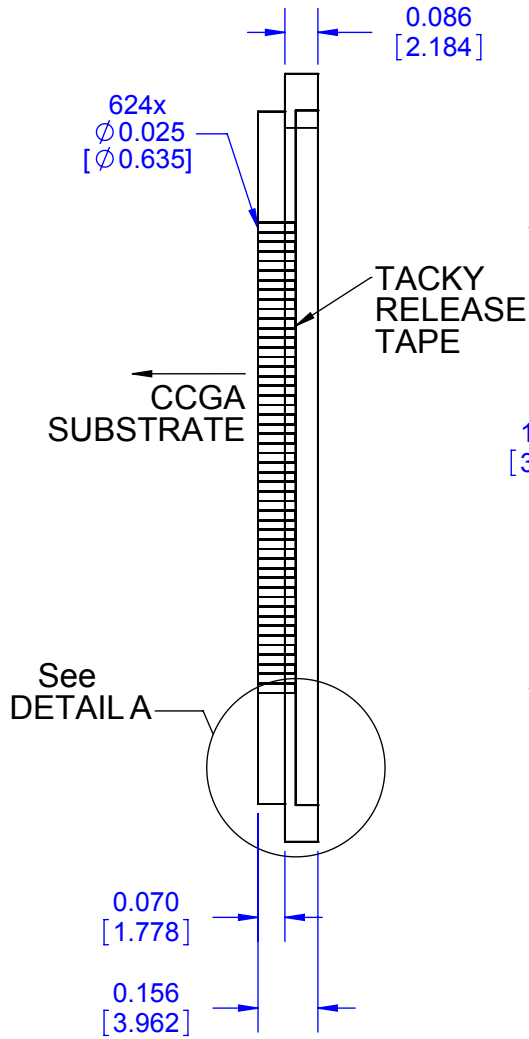

MODEL

NOTES:
1. DIMENSIONS INCHES [MM].
2. SHOWN WITH MAXIMUM ARRAY.

TopLine®			
TITLE PP624 PIN-PACK™ CCGA COLUMN CARRIER			
SCALE 2:1	SIZE A	DRAWING NO. 002250	REV A
DO NOT SCALE DRAWING			SHEET 1 OF 8

DETAIL A

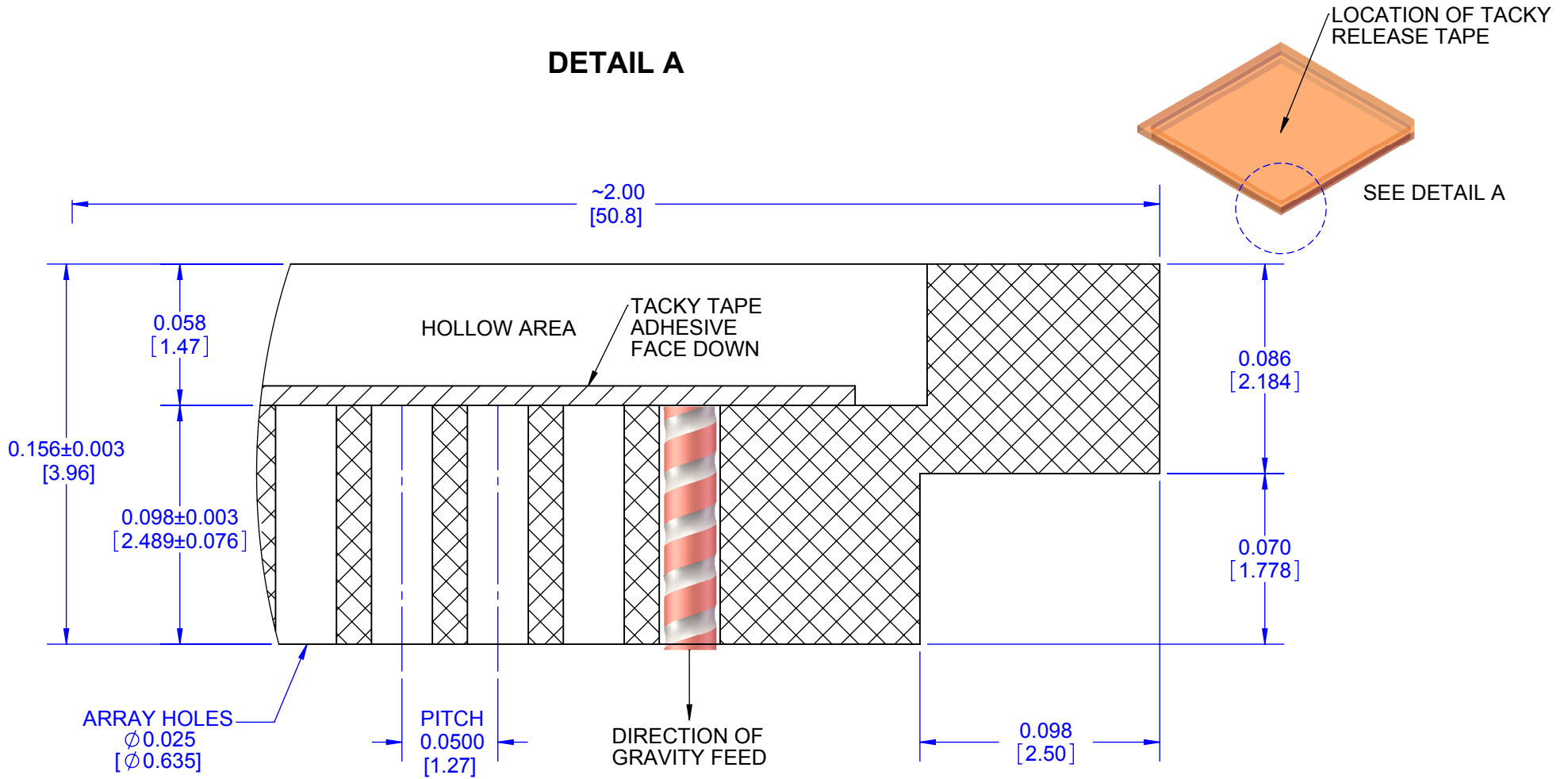

EXAMPLES OF COLUMNS

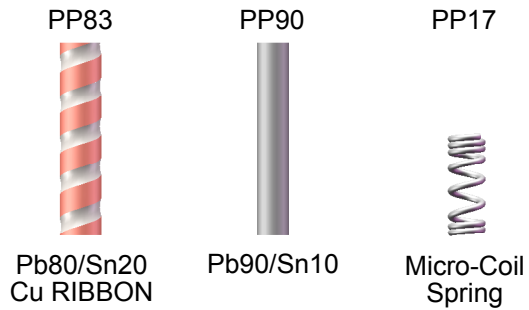

NOTES:
1. DIMENSIONS INCHES [MM].

TopLine[®]

TITLE PP624 PIN-PACK™
CCGA COLUMN CARRIER

SCALE 16:1	SIZE A	DRAWING NO. 002250	REV A
---------------	-----------	-----------------------	----------

DO NOT SCALE DRAWING

SHEET 2 OF 8

PART NUMBER TABLE

PIN-PACK™	Pins	Pitch	Matrix	COLUMN				Empty DWG	Filled DWG
				Alloy	Construction	∅ Dia	Length		
PP83C624F22x100A	624	1.27mm	25x25	Pb80	Cu Ribbon	0.56mm	2.54mm	002250	832250
PP90U624F20x100A				Pb90	Plain	0.51mm	2.54mm		902250
PP17P624F20x50A				MCS	Micro Coil	0.51mm	1.27mm		172250

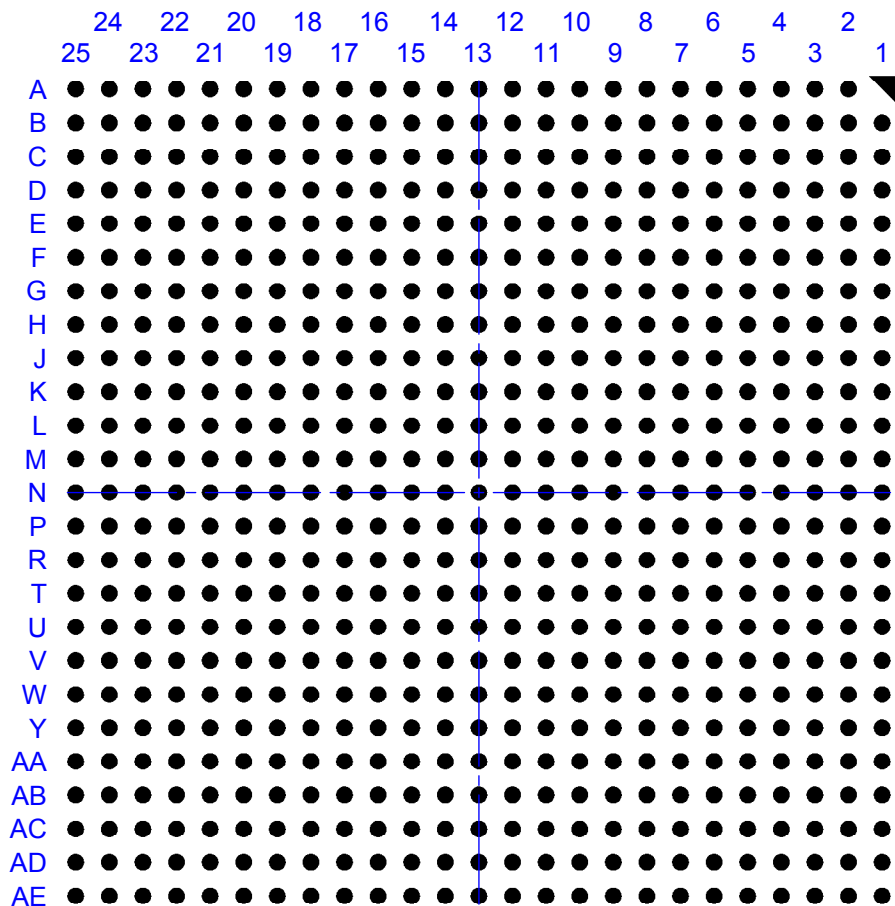

EXAMPLES OF COLUMNS

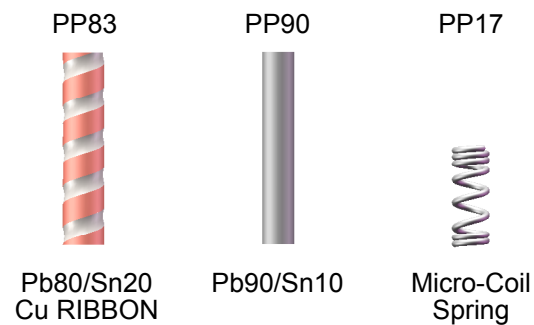

TITLE PP624 PIN-PACK™
CCGA COLUMN CARRIER

SCALE NONE	SIZE A	DRAWING NO. 002250	REV A
---------------	-----------	-----------------------	----------

DO NOT SCALE DRAWING

SHEET 3 OF 8

PIN-PACK™ PART NUMBERING SYSTEM

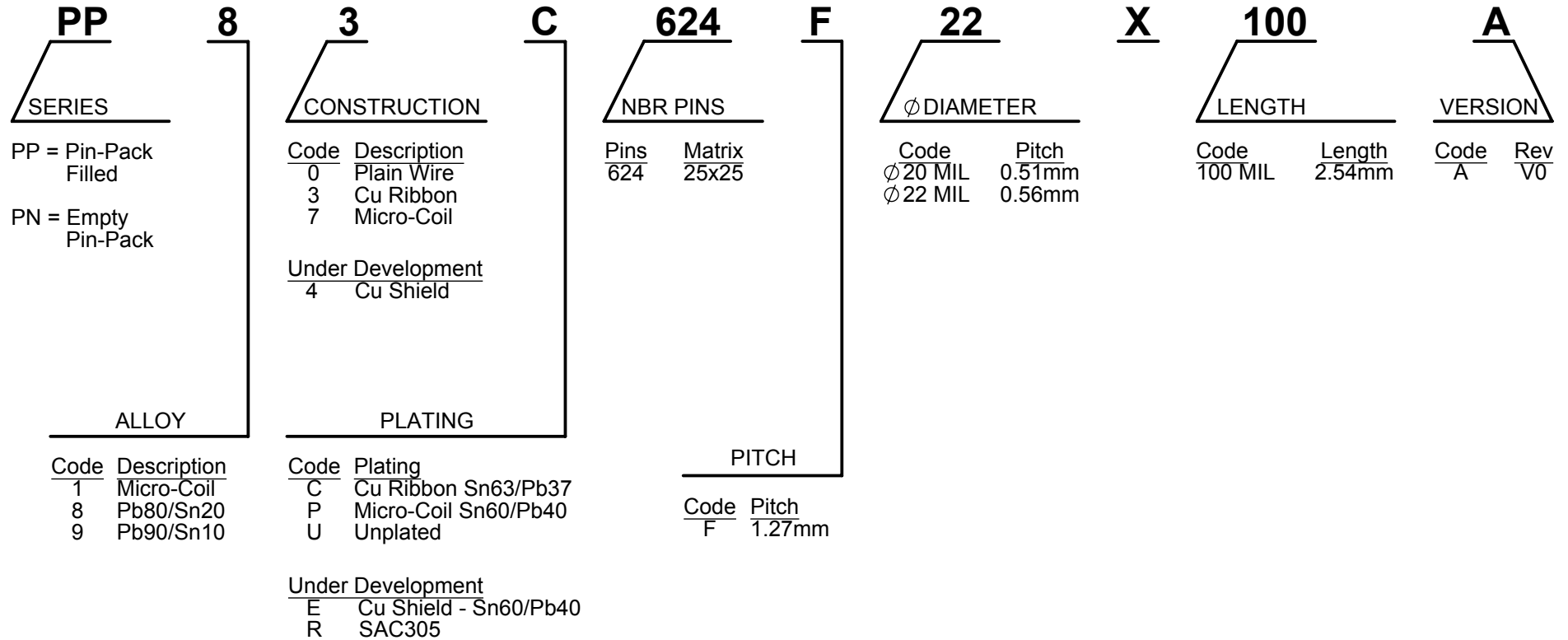

EXAMPLES OF COLUMNS

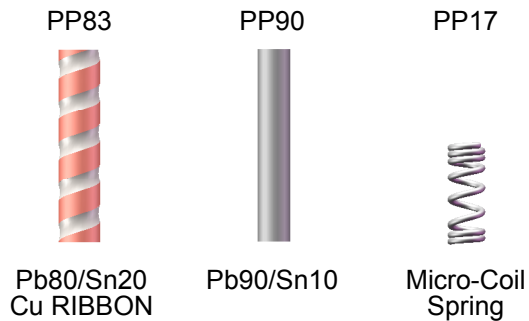

NOTE 1: PP83, PP90 and PP93 REQUIRES TRIMMING TO FINISHED LENGTH.
 NOTE 2: COLUMN 2.54mm TO BE TRIMMED TO 2.21mm AFTER ATTACHMENT.

TopLine®			
TITLE PP624 PIN-PACK™ CCGA COLUMN CARRIER			
SCALE 10:1	SIZE A	DRAWING NO. 002250	REV A
DO NOT SCALE DRAWING			SHEET 4 OF 8

PIN-PACK™ DRAWING NUMBERING SYSTEM

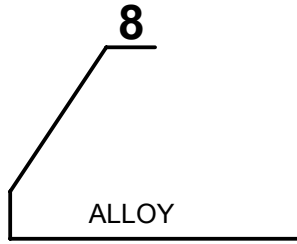

Code	Description
00	Empty
1	Micro-Coil
8	Pb80/Sn20
9	Pb90/Sn10

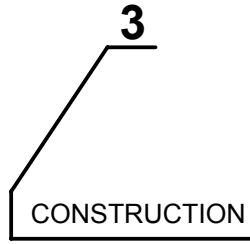

Code	Description
0	Plain Wire
3	Cu Ribbon
7	Micro-Coil

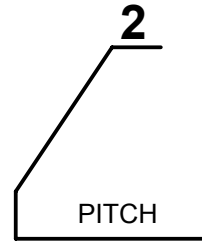

Code	Pitch
2	1.27mm

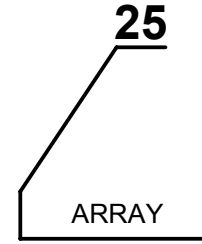

Code	Matrix
25	25x25

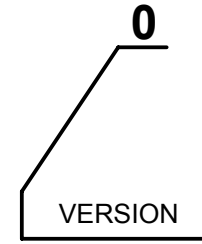

Code	Rev
0	624 PINS

Under Development

4	Cu + Sn60/Pb40
5	Cu + SAC
6	Sn60/Pb40

EXAMPLES OF COLUMNS

PP83



Pb80/Sn20
Cu RIBBON

PP90



Pb90/Sn10

PP17



Micro-Coil
Spring

TopLine®

TITLE PP624 PIN-PACK™
CCGA COLUMN CARRIER

SCALE	SIZE	DRAWING NO.	REV
10:1	A	002250	A

DO NOT SCALE DRAWING

SHEET 5 OF 8

PIN-PACK™ OUTLINE

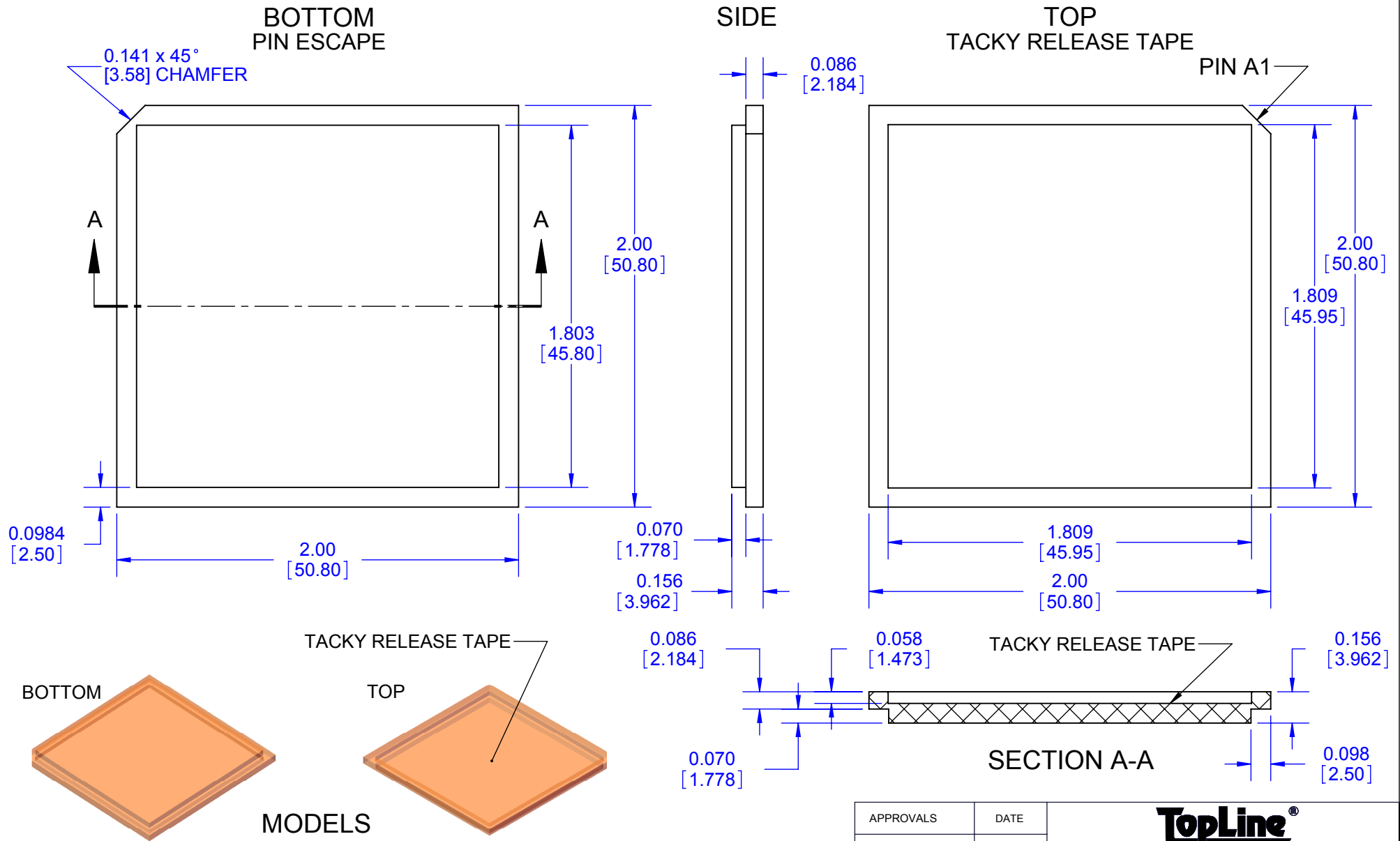

- NOTES:**
1. DIMENSIONS INCHES [MM].
 2. SHOWN WITHOUT HOLES FOR CLARITY.
 3. PIN-PACK™ IS TRADEMARK OF TOPLINE.
 4. PIN-PACK™ PATENT PENDING.

APPROVALS	DATE	TopLine®			
DRAWN T.Au	10/01/14				
ENG M. Hart	10/01/14	TITLE PP624 PIN-PACK™ CCGA COLUMN CARRIER			
MFG		SCALE	SIZE	DRAWING NO.	REV
QA		3:2	A	002250	A
CUST		DO NOT SCALE DRAWING			SHEET 6 OF 8
REVISED					

TACKY RELEASE TAPE TOP VIEW

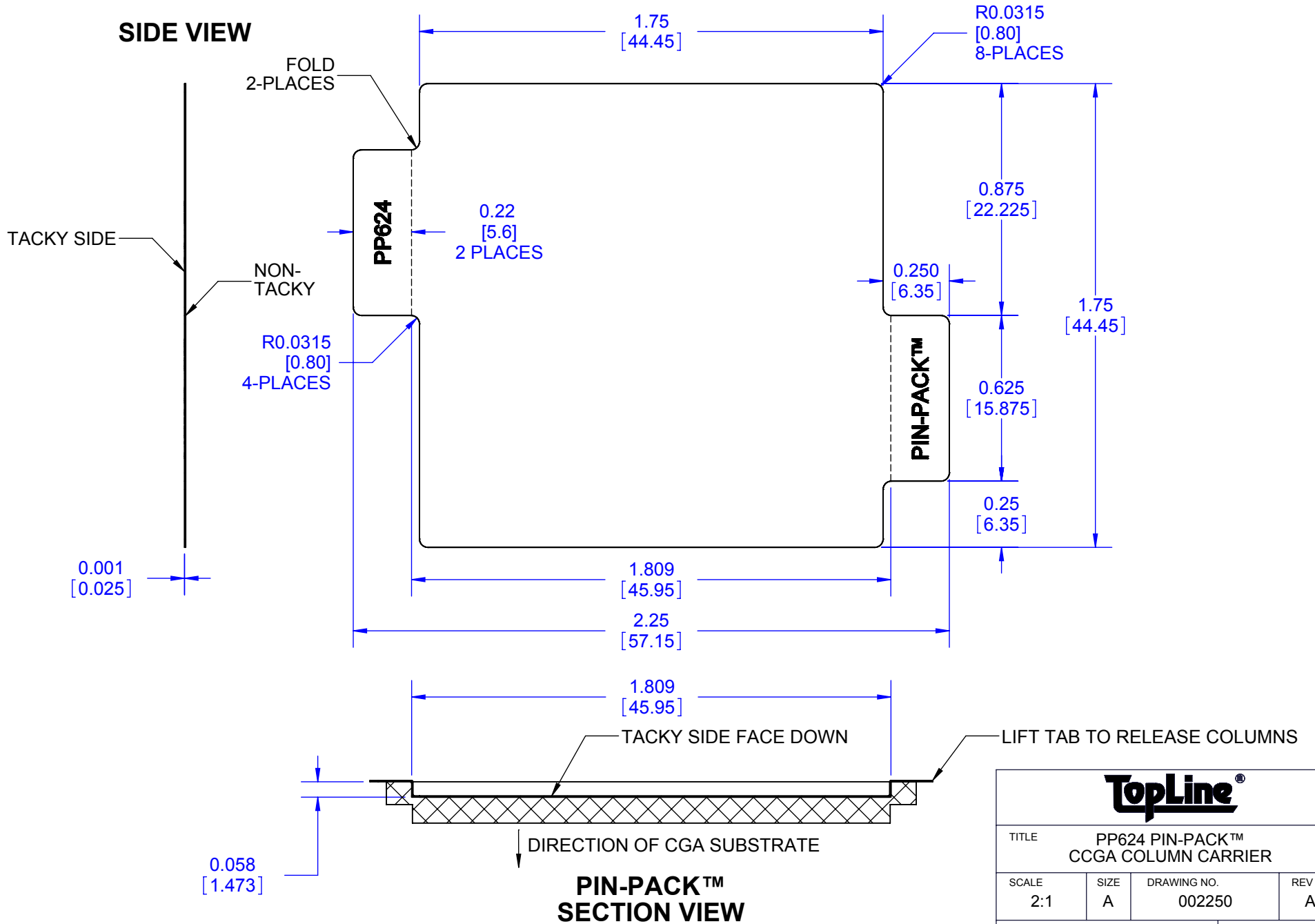

TopLine®			
TITLE PP624 PIN-PACK™ CCGA COLUMN CARRIER			
SCALE 2:1	SIZE A	DRAWING NO. 002250	REV A
DO NOT SCALE DRAWING			SHEET 7 OF 8

TACKY RELEASE TAPE MODEL

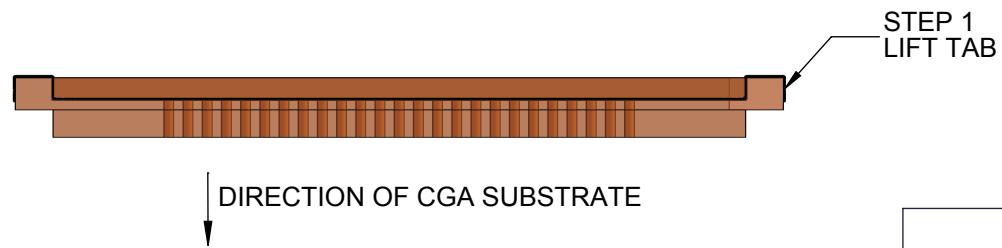
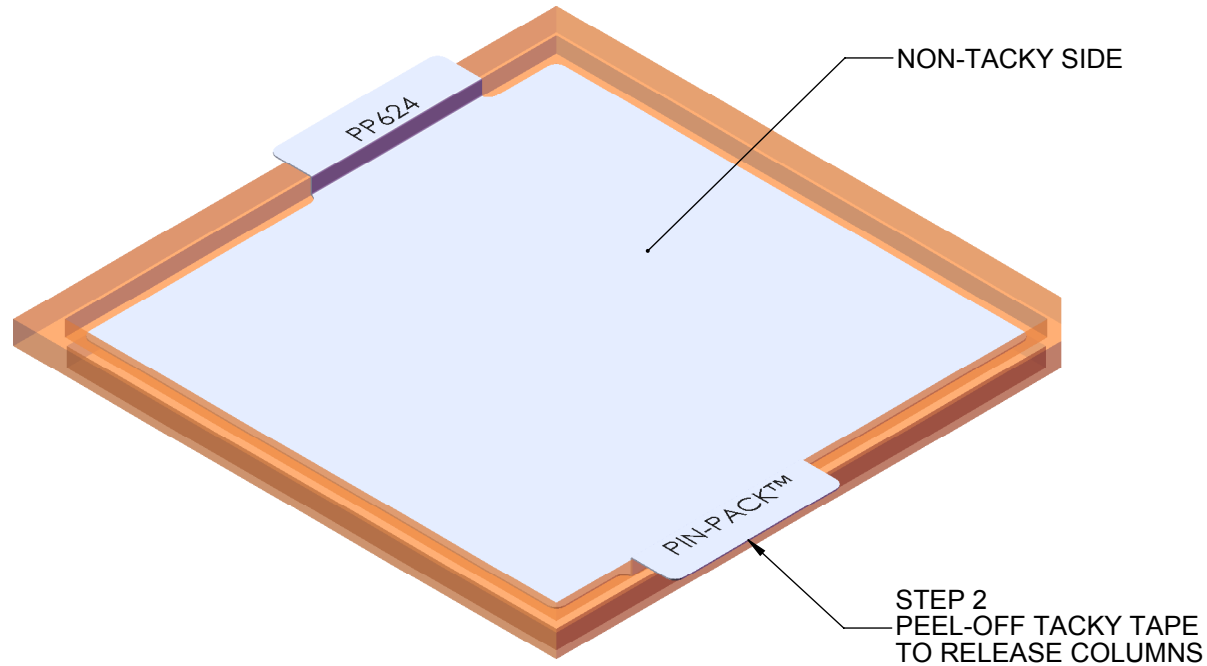

TopLine®			
TITLE PP624 PIN-PACK™ CCGA COLUMN CARRIER			
SCALE 2:1	SIZE A	DRAWING NO. 002250	REV A
DO NOT SCALE DRAWING			SHEET 8 OF 8