

**TOP**

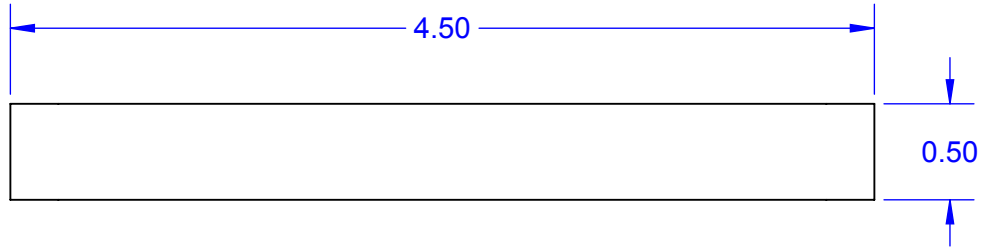

**EDGE**

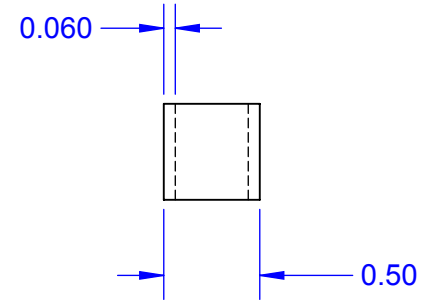

**SIDE**

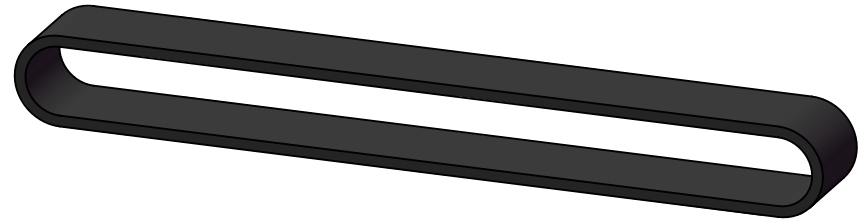
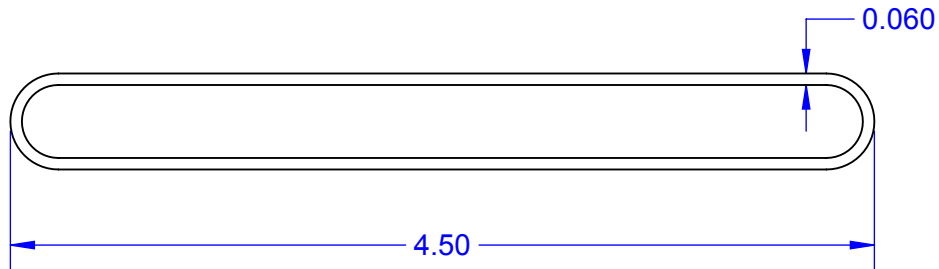

**MODEL**

Notes: (Unless Otherwise Specified).

- 1) SURFACE RESISTIVITY:  $10^3 \Omega$  TO  $10^6 \Omega$  PER SQUARE.
- 2) DIMENSIONS in INCHES (RESTING POSITION).

APPROVALS	DATE	<b>TopLine®</b>			
DRAWN T.Au	04/07/15				
ENG M. Hart	04/07/15	TITLE RUBBER BAND-4.5-C BLACK CONDUCTIVE			
MFG		SCALE 1:1	SIZE A	DRAWING NO.	REV
QA				090007	A
CUST		DO NOT SCALE DRAWING			SHEET 1 OF 1
REVISED					