

### BOTTOM VIEW

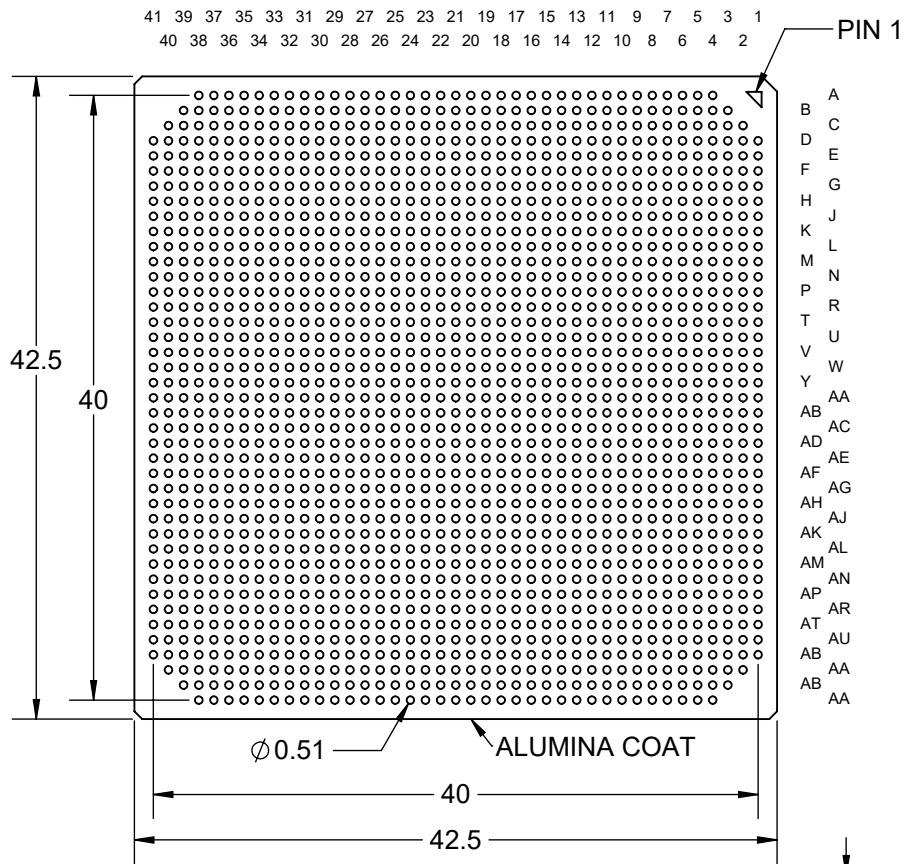

### SIDE VIEW

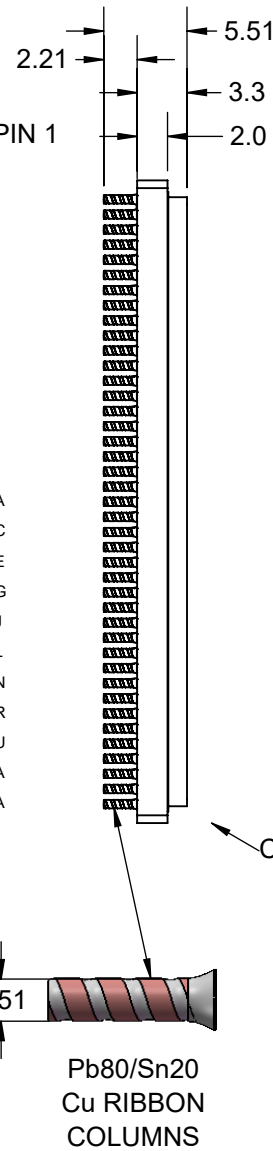

### TOP VIEW

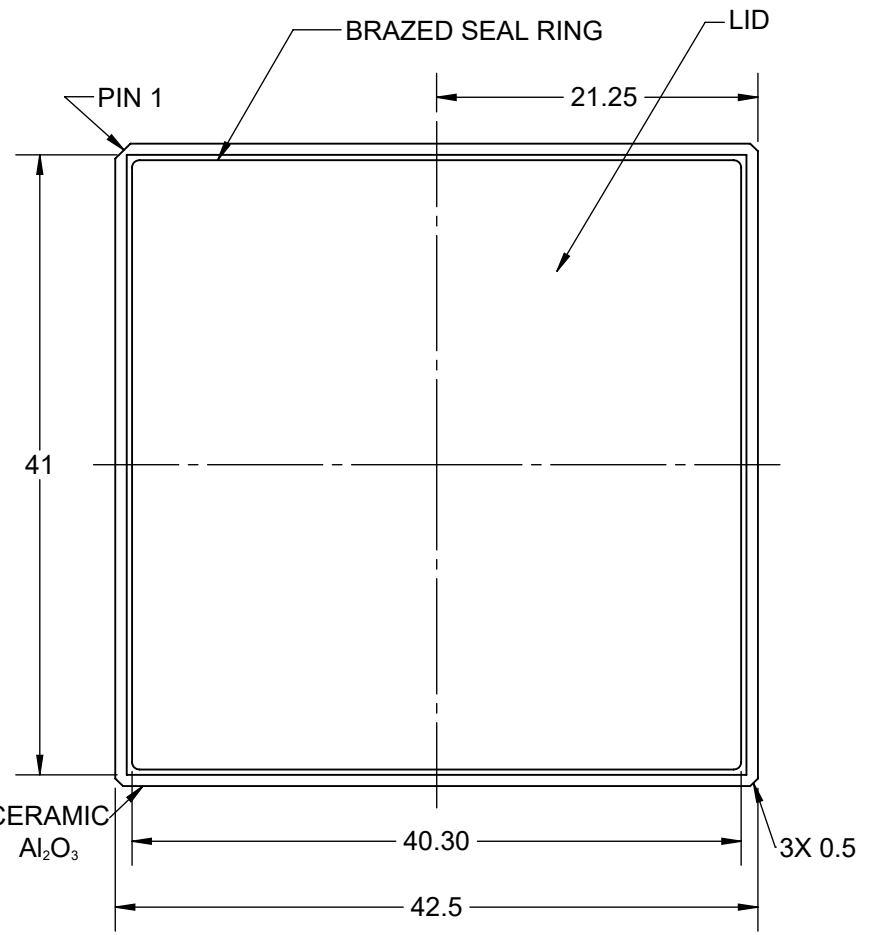

- Notes: (Unless Otherwise Specified).  
 1) DIMENSIONS ARE IN mm.  
 2) CCGA SHOWN WITH COLUMNS.  
 3) SHOWN WITH LID.  
 4) SHOWN WITH DUMMY DIE.  
 5) PART NUMBER CCGA1657T1.0-DC416D.

#### PART NUMBER OPTIONS

PART NUMBER	DUMMY DIE	SOLDER PIN	LID
CCGA1657T1.0-DC416D	YES	YES	YES

APPROVALS		DATE				
DRAWN	T.Au	9/23/2019				
ENG	M. Hart	9/23/2019	TITLE CCGA1657T1.0-DC416D DUMMY COLUMN GRID ARRAY			
MFG			SCALE	SIZE	DRAWING NO.	REV
QA			2:1	A	160193	A
CUST						
REVISED			DO NOT SCALE DRAWING			SHEET 1 OF 7

# DAISY CHAIN PATTERN

## COLUMN (BALL) VIEW

41 39 37 35 33 31 29 27 25 23 21 19 17 15 13 11 9 7 5 3 1  
40 38 36 34 32 30 28 26 24 22 20 18 16 14 12 10 8 6 4 2

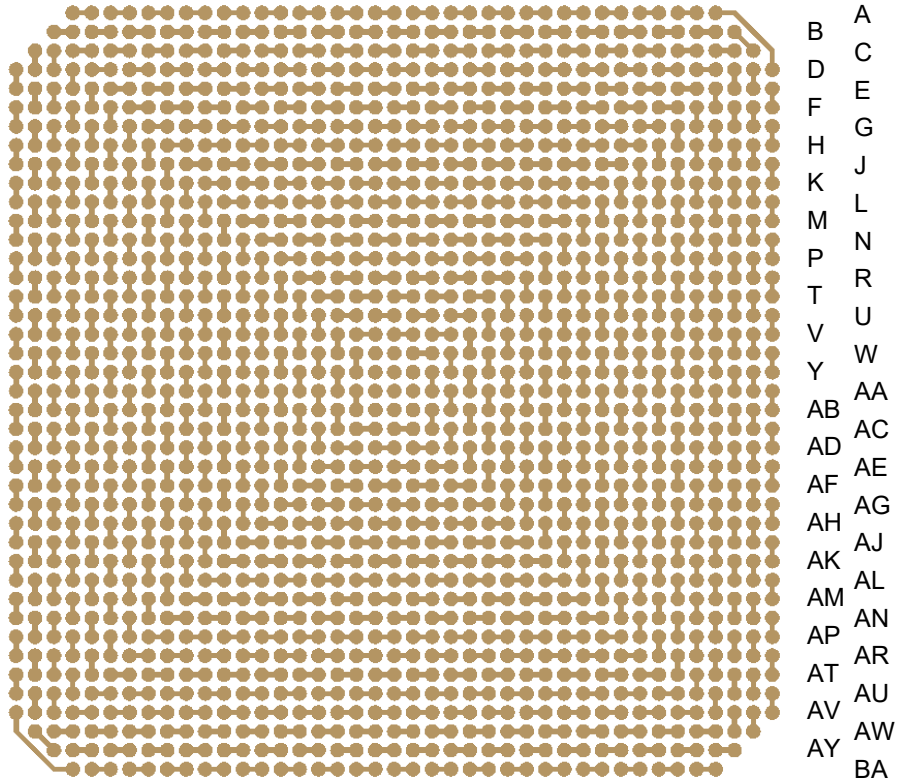

## BOTTOM X-RAY VIEWED FROM TOP

1 3 5 7 9 11 13 15 17 19 21 23 25 27 29 31 33 35 37 39 41  
2 4 6 8 10 12 14 16 18 20 22 24 26 28 30 32 34 36 38 40

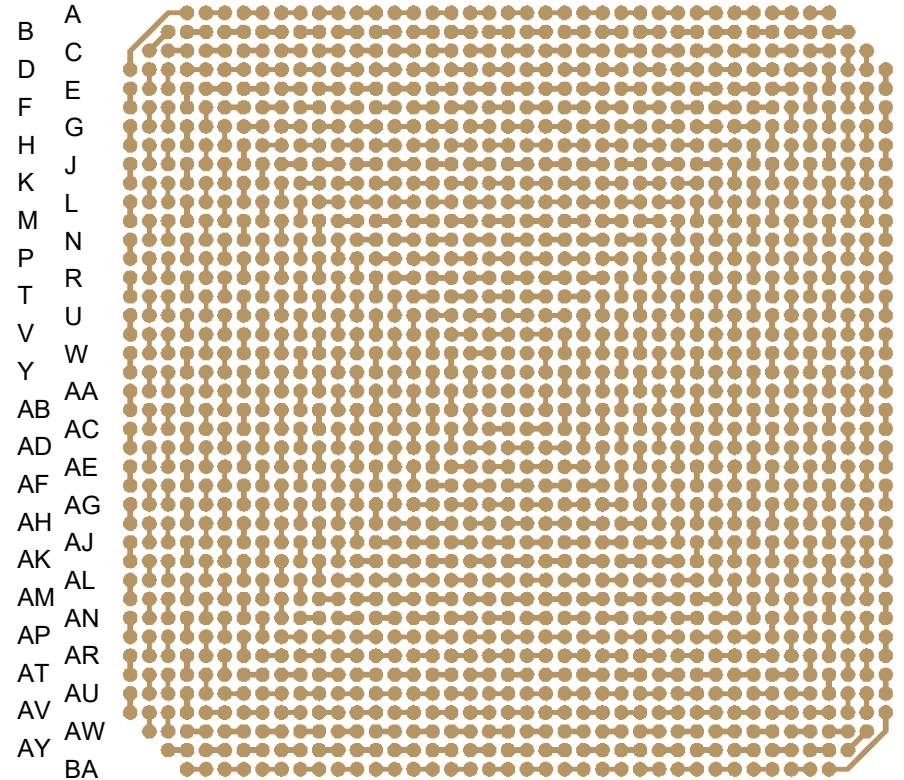

**TopLine®**

TITLE CCGA1657T1.0-DC416D  
DUMMY COLUMN GRID ARRAY

SCALE	SIZE	DRAWING NO.	REV
2.5:1	A	160193	A

DO NOT SCALE DRAWING

SHEET 2 OF 7

# NET LIST DAISY CHAIN CONNECTION TABLE

DC PAIR	
A4	D1
A5	A6
A7	A8
A9	A10
A11	A12
A13	A14
A15	A16
A17	A18
A19	A20
A21	A22
A23	A24
A25	A26
A27	A28
A29	A30
A31	A32
A33	A34
A35	A36
A37	A38
B3	C2
B4	B5
B6	B7
B8	B9
B10	B11
B12	B13
B14	B15
B16	B17
B18	B19
B20	B21
B22	B23
B24	B25
B26	B27
B28	B29
B30	B31
B32	B33
B34	B35
B36	B37

DC PAIR	
C3	C4
C5	C6
C7	C8
C9	C10
C11	C12
C13	C14
C15	C16
C17	C18
C19	C20
C21	C22
C23	C24
C25	C26
C27	C28
C29	C30
C31	C32
C33	C34
C35	C36
C37	C38
C39	D39
C40	D40
D2	E2
D3	E3
D4	D5
D6	D7
D8	D9
D10	D11
D12	D13
D14	D15
D16	D17
D18	D19
D20	D21
D22	D23
D24	D25
D26	D27
D28	D29
D30	D31
D32	D33
D34	D35
D36	D37
D38	E38
D41	E41

DC PAIR	
E1	F1
E4	F4
E5	E6
E7	E8
E9	E10
E11	E12
E13	E14
E15	E16
E17	E18
E19	E20
E21	E22
E23	E24
E25	E26
E27	E28
E29	E30
E31	E32
E33	E34
E35	E36
E37	F37
E39	F39
E40	F40
F2	G2
F3	G3
F5	G5
F6	F7
F8	F9
F10	F11
F12	F13
F14	F15
F16	F17
F18	F19
F20	F21
F22	F23
F24	F25
F26	F27
F28	F29
F30	F31
F32	F33
F34	F35
F36	G36
F38	G38
F41	G41

DC PAIR	
G1	H1
G4	H4
G6	H6
G7	G8
G9	G10
G11	G12
G13	G14
G15	G16
G17	G18
G19	G20
G21	G22
G23	G24
G25	G26
G27	G28
G29	G30
G31	G32
G33	G34
G35	H35
G37	H37
G39	H39
G40	H40
H2	J2
H3	J3
H5	J5
H7	J7
H8	H9
H10	H11
H12	H13
H14	H15
H16	H17
H18	H19
H20	H21
H22	H23
H24	H25
H26	H27
H28	H29
H30	H31
H32	H33
H34	J34
H36	J36
H38	J38
H41	J41

DC PAIR	
J1	K1
J4	K4
J6	K6
J8	K8
J9	J10
J11	J12
J13	J14
J15	J16
J17	J18
J19	J20
J21	J22
J23	J24
J25	J26
J27	J28
J29	J30
J31	J32
J33	K33
J35	K35
J37	K37
J39	K39
J40	K40
K2	L2
K3	L3
K5	L5
K7	L7
K9	L9
K10	K11
K12	K13
K14	K15
K16	K17
K18	K19
K20	K21
K22	K23
K24	K25
K26	K27
K28	K29
K30	K31
K32	L32
K34	L34
K36	L36
K38	L38
K41	L41

DC PAIR	
L1	M1
L4	M4
L6	M6
L8	M8
L10	M10
L11	L12
L13	L14
L15	L16
L17	L18
L19	L20
L21	L22
L23	L24
L25	L26
L27	L28
L29	L30
L31	M31
L33	M33
L35	M35
L37	M37
L39	M39
L40	M40
M2	N2
M3	N3
M5	N5
M7	N7
M9	N9
M11	N11
M12	M13
M14	M15
M16	M17
M18	M19
M20	M21
M22	M23
M24	M25
M26	M27
M28	M29
M30	N30
M32	N32
M34	N34
M36	N36
M38	N38
M41	N41

DC PAIR	
N1	P1
N4	P4
N6	P6
N8	P8
N10	P10
N12	P12
N13	N14
N15	N16
N17	N18
N19	N20
N21	N22
N23	N24
N25	N26
N27	N28
N29	P29
N31	P31
N33	P33
N35	P35
N37	P37
N39	P39
N40	P40
P2	R2
P3	R3
P5	R5
P7	R7
P9	R9
P11	R11
P13	R13
P14	P15
P16	P17
P18	P19
P20	P21
P22	P23
P24	P25
P26	P27
P28	R28
P30	R30
P32	R32
P34	R34
P36	R36
P38	R38
P41	R41

CONTINUED NEXT PAGE

<b>TopLine®</b>			
TITLE CCGA1657T1.0-DC416D DUMMY COLUMN GRID ARRAY			
SCALE NONE	SIZE A	DRAWING NO. 160193	REV A
DO NOT SCALE DRAWING			SHEET 3 OF 7

# NET LIST DAISY CHAIN CONNECTION TABLE

DC PAIR		DC PAIR		DC PAIR		DC PAIR		DC PAIR		DC PAIR		DC PAIR	
R1	T1	U1	V1	W1	Y1	Y38	AA38	AB34	AC34	AD38	AE38	AG1	AH1
R4	T4	U4	V4	W4	Y4	Y41	AA41	AB36	AC36	AD41	AE41	AG4	AH4
R6	T6	U6	V6	W6	Y6	AA1	AB1	AB38	AC38	AE1	AF1	AG6	AH6
R8	T8	U8	V8	W8	Y8	AA4	AB4	AB41	AC41	AE4	AF4	AG8	AH8
R10	T10	U10	V10	W10	Y10	AA6	AB6	AC1	AD1	AE6	AF6	AG10	AH10
R12	T12	U12	V12	W12	Y12	AA8	AB8	AC4	AD4	AE8	AF8	AG12	AH12
R14	T14	U14	V14	W14	Y14	AA10	AB10	AC6	AD6	AE10	AF10	AG14	AH14
R15	R16	U16	V16	W16	Y16	AA12	AB12	AC8	AD8	AE12	AF12	AG16	AG17
R17	R18	U17	U18	W18	Y18	AA14	AB14	AC10	AD10	AE14	AF14	AG18	AG19
R19	R20	U19	U20	W19	W20	AA16	AB16	AC12	AD12	AE16	AF16	AG20	AG21
R21	R22	U21	U22	W21	NC	AA18	AB18	AC14	AD14	AE18	AE19	AG22	AG23
R23	R24	U23	U24	W22	NC	AA20	NC	AC16	AD16	AE20	AE21	AG24	AG25
R25	R26	U25	V25	W23	Y23	AA21	NC	AC18	AD18	AE22	AE23	AG26	AG27
R27	T27	U27	V27	W25	Y25	AA22	NC	AC20	AC21	AE24	AE25	AG29	AH29
R29	T29	U29	V29	W27	Y27	AA23	AB23	AC22	AC23	AE27	AF27	AG31	AH31
R31	T31	U31	V31	W29	Y29	AA25	AB25	AC25	AD25	AE29	AF29	AG33	AH33
R33	T33	U33	V33	W31	Y31	AA27	AB27	AC27	AD27	AE31	AF31	AG35	AH35
R35	T35	U35	V35	W33	Y33	AA29	AB29	AC29	AD29	AE33	AF33	AG37	AH37
R37	T37	U37	V37	W35	Y35	AA31	AB31	AC31	AD31	AE35	AF35	AG39	AH39
R39	T39	U39	V39	W37	Y37	AA33	AB33	AC33	AD33	AE37	AF37	AG40	AH40
R40	T40	U40	V40	W39	Y39	AA35	AB35	AC35	AD35	AE39	AF39	AH2	AJ2
T2	U2	V2	W2	W40	Y40	AA37	AB37	AC37	AD37	AE40	AF40	AH3	AJ3
T3	U3	V3	W3	Y2	AA2	AA39	AB39	AC39	AD39	AF2	AG2	AH5	AJ5
T5	U5	V5	W5	Y3	AA3	AA40	AB40	AC40	AD40	AF3	AG3	AH7	AJ7
T7	U7	V7	W7	Y5	AA5	AB2	AC2	AD2	AE2	AF5	AG5	AH9	AJ9
T9	U9	V9	W9	Y7	AA7	AB3	AC3	AD3	AE3	AF7	AG7	AH11	AJ11
T11	U11	V11	W11	Y9	AA9	AB5	AC5	AD5	AE5	AF9	AG9	AH13	AJ13
T13	U13	V13	W13	Y11	AA11	AB7	AC7	AD7	AE7	AF11	AG11	AH15	AH16
T15	U15	V15	W15	Y13	AA13	AB9	AC9	AD9	AE9	AF13	AG13	AH17	AH18
T16	T17	V17	W17	Y15	AA15	AB11	AC11	AD11	AE11	AF15	AG15	AH19	AH20
T18	T19	V18	V19	Y17	AA17	AB13	AC13	AD13	AE13	AF17	AF18	AH21	AH22
T20	T21	V20	V21	Y19	AA19	AB15	AC15	AD15	AE15	AF19	AF20	AH23	AH24
T22	T23	V22	V23	Y20	NC	AB17	AC17	AD17	AE17	AF21	AF22	AH25	AH26
T24	T25	V24	W24	Y21	NC	AB19	AC19	AD19	AD20	AF23	AF24	AH27	AH28
T26	U26	V26	W26	Y22	NC	AB20	NC	AD21	AD22	AF25	AF26	AH30	AJ30
T28	U28	V28	W28	Y24	AA24	AB21	NC	AD23	AD24	AF28	AG28	AH32	AJ32
T30	U30	V30	W30	Y26	AA26	AB22	NC	AD26	AE26	AF30	AG30	AH34	AJ34
T32	U32	V32	W32	Y28	AA28	AB24	AC24	AD28	AE28	AF32	AG32	AH36	AJ36
T34	U34	V34	W34	Y30	AA30	AB26	AC26	AD30	AE30	AF34	AG34	AH38	AJ38
T36	U36	V36	W36	Y32	AA32	AB28	AC28	AD32	AE32	AF36	AG36	AH41	AJ41
T38	U38	V38	W38	Y34	AA34	AB30	AC30	AD34	AE34	AF38	AG38		
T41	U41	V41	W41	Y36	AA36	AB32	AC32	AD36	AE36	AF41	AG41		

AA21 NO CONNECTION

CONTINUED NEXT PAGE

			
TITLE CCGA1657T1.0-DC416D DUMMY COLUMN GRID ARRAY			
SCALE NONE	SIZE A	DRAWING NO. 160193	REV A
DO NOT SCALE DRAWING			SHEET 4 OF 7

# NET LIST DAISY CHAIN CONNECTION TABLE

DC PAIR	
AJ1	AK1
AJ4	AK4
AJ6	AK6
AJ8	AK8
AJ10	AK10
AJ12	AK12
AJ14	AJ15
AJ16	AJ17
AJ18	AJ19
AJ20	AJ21
AJ22	AJ23
AJ24	AJ25
AJ26	AJ27
AJ28	AJ29
AJ31	AK31
AJ33	AK33
AJ35	AK35
AJ37	AK37
AJ39	AK39
AJ40	AK40
AK2	AL2
AK3	AL3
AK5	AL5
AK7	AL7
AK9	AL9
AK11	AL11
AK13	AK14
AK15	AK16
AK17	AK18
AK19	AK20
AK21	AK22
AK23	AK24
AK25	AK26
AK27	AK28
AK29	AK30
AK32	AL32
AK34	AL34
AK36	AL36
AK38	AL38
AK41	AL41

DC PAIR	
AL1	AM1
AL4	AM4
AL6	AM6
AL8	AM8
AL10	AM10
AL12	AL13
AL14	AL15
AL16	AL17
AL18	AL19
AL20	AL21
AL22	AL23
AL24	AL25
AL26	AL27
AL28	AL29
AL30	AL31
AL33	AM33
AL35	AM35
AL37	AM37
AL39	AM39
AL40	AM40
AM2	AN2
AM3	AN3
AM5	AN5
AM7	AN7
AM9	AN9
AM11	AM12
AM13	AM14
AM15	AM16
AM17	AM18
AM19	AM20
AM21	AM22
AM23	AM24
AM25	AM26
AM27	AM28
AM29	AM30
AM31	AM32
AM34	AN34
AM36	AN36
AM38	AN38
AM41	AN41

DC PAIR	
AN1	AP1
AN4	AP4
AN6	AP6
AN8	AP8
AN10	AN11
AN12	AN13
AN14	AN15
AN16	AN17
AN18	AN19
AN20	AN21
AN22	AN23
AN24	AN25
AN26	AN27
AN28	AN29
AN30	AN31
AN32	AN33
AN35	AP35
AN37	AP37
AN39	AP39
AN40	AP40
AP2	AR2
AP3	AR3
AP5	AR5
AP7	AR7
AP9	AP10
AP11	AP12
AP13	AP14
AP15	AP16
AP17	AP18
AP19	AP20
AP21	AP22
AP23	AP24
AP25	AP26
AP27	AP28
AP29	AP30
AP31	AP32
AP33	AP34
AP36	AR36
AP38	AR38
AP41	AR41

DC PAIR	
AR1	AT1
AR4	AT4
AR6	AT6
AR8	AR9
AR10	AR11
AR12	AR13
AR14	AR15
AR16	AR17
AR18	AR19
AR20	AR21
AR22	AR23
AR24	AR25
AR26	AR27
AR28	AR29
AR30	AR31
AR32	AR33
AR34	AR35
AR37	AT37
AR39	AT39
AR40	AT40
AT2	AU2
AT3	AU3
AT5	AU5
AT7	AT8
AT9	AT10
AT11	AT12
AT13	AT14
AT15	AT16
AT17	AT18
AT19	AT20
AT21	AT22
AT23	AT24
AT25	AT26
AT27	AT28
AT29	AT30
AT31	AT32
AT33	AT34
AT35	AT36
AT38	AU38
AT41	AU41

DC PAIR	
AU1	AV1
AU4	AV4
AU6	AU7
AU8	AU9
AU10	AU11
AU12	AU13
AU14	AU15
AU16	AU17
AU18	AU19
AU20	AU21
AU22	AU23
AU24	AU25
AU26	AU27
AU28	AU29
AU30	AU31
AU32	AU33
AU34	AU35
AU36	AU37
AU39	AV39
AU40	AV40
AV2	AW2
AV3	AW3
AV5	AV6
AV7	AV8
AV9	AV10
AV11	AV12
AV13	AV14
AV15	AV16
AV17	AV18
AV19	AV20
AV21	AV22
AV23	AV24
AV25	AV26
AV27	AV28
AV29	AV30
AV31	AV32
AV33	AV34
AV35	AV36
AV37	AV38
AV41	BA38

DC PAIR	
AW4	AW5
AW6	AW7
AW8	AW9
AW10	AW11
AW12	AW13
AW14	AW15
AW16	AW17
AW18	AW19
AW20	AW21
AW22	AW23
AW24	AW25
AW26	AW27
AW28	AW29
AW30	AW31
AW32	AW33
AW34	AW35
AW36	AW37
AW38	AW39
AW40	AY39
AY3	AY4
AY5	AY6
AY7	AY8
AY9	AY10
AY11	AY12
AY13	AY14
AY15	AY16
AY17	AY18
AY19	AY20
AY21	AY22
AY23	AY24
AY25	AY26
AY27	AY28
AY29	AY30
AY31	AY32
AY33	AY34
AY35	AY36
AY37	AY38

DC PAIR	
BA4	BA5
BA6	BA7
BA8	BA9
BA10	BA11
BA12	BA13
BA14	BA15
BA16	BA17
BA18	BA19
BA20	BA21
BA22	BA23
BA24	BA25
BA26	BA27
BA28	BA29
BA30	BA31
BA32	BA33
BA34	BA35
BA36	BA37

<b>TopLine®</b>			
TITLE CCGA1657T1.0-DC416D DUMMY COLUMN GRID ARRAY			
SCALE NONE	SIZE A	DRAWING NO. 160193	REV A
DO NOT SCALE DRAWING			SHEET 5 OF 7

# SOLDER PIN OPTIONS

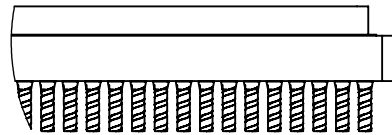
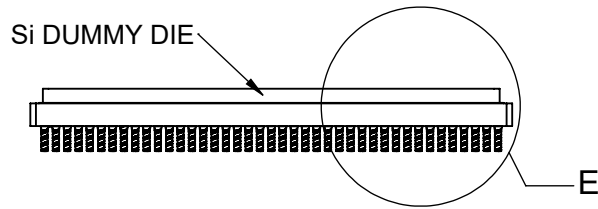

DETAIL E  
SCALE 3 : 1

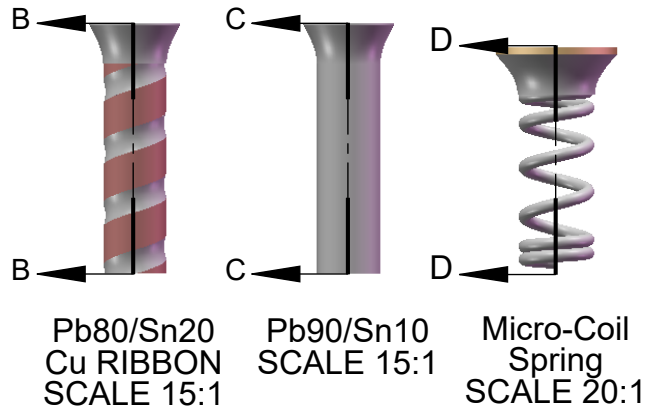
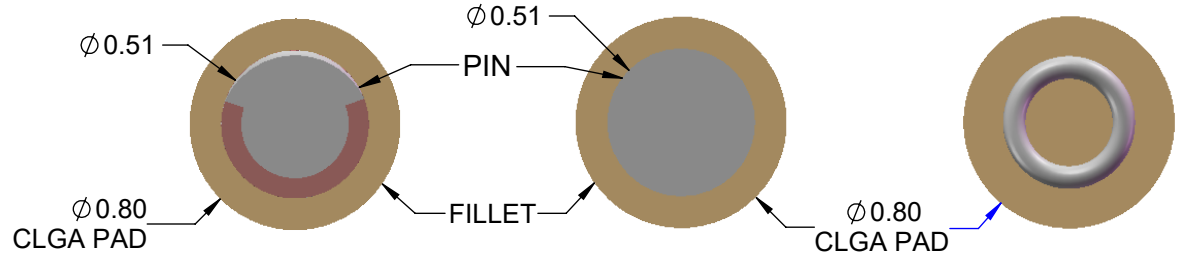
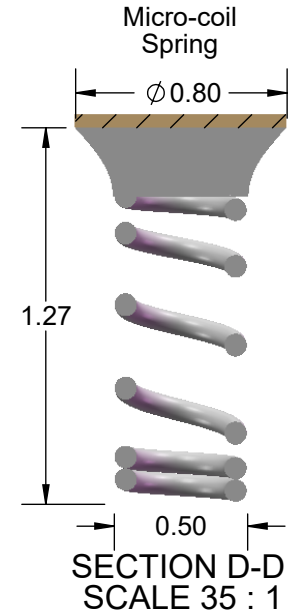
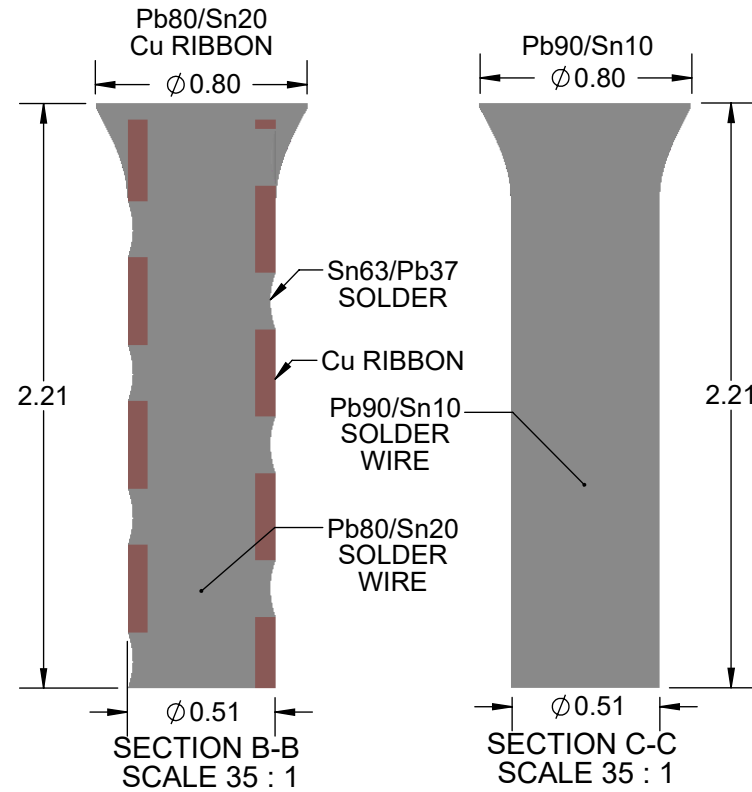

PART NUMBER OPTIONS		
PART NUMBER	DUMMY DIE	SOLDER PIN
CCGA1657T1.0-DC416D	YES	Pb80/Sn20 Cu RIBBON
CCGA1657T1.0A-DC416D	YES	Pb90/Sn10
CCGA1657T1.0M-DC416D	YES	Micro-Coil
CLGA1657T1.0-DC416D	YES	NONE

TITLE			
CCGA1657T1.0-DC416D DUMMY COLUMN GRID ARRAY			
SCALE	SIZE	DRAWING NO.	REV
35:1	A	160193	A
DO NOT SCALE DRAWING			SHEET 6 OF 7

**MODEL CCGA1657T1.0-DC416D  
Pb80/Sn20 Copper Wrap Columns**

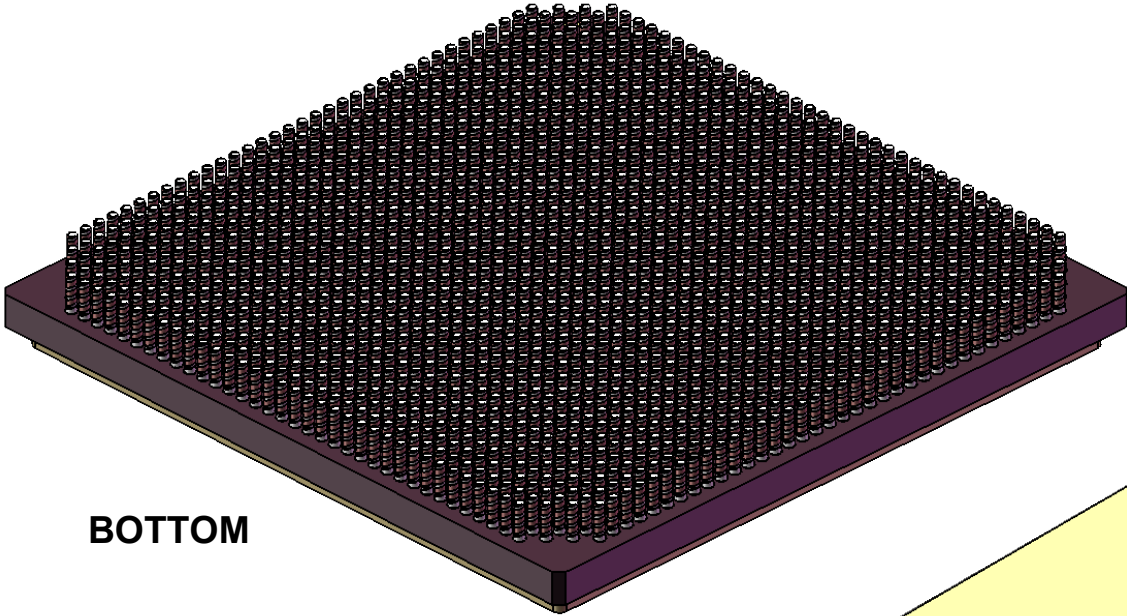

**BOTTOM**

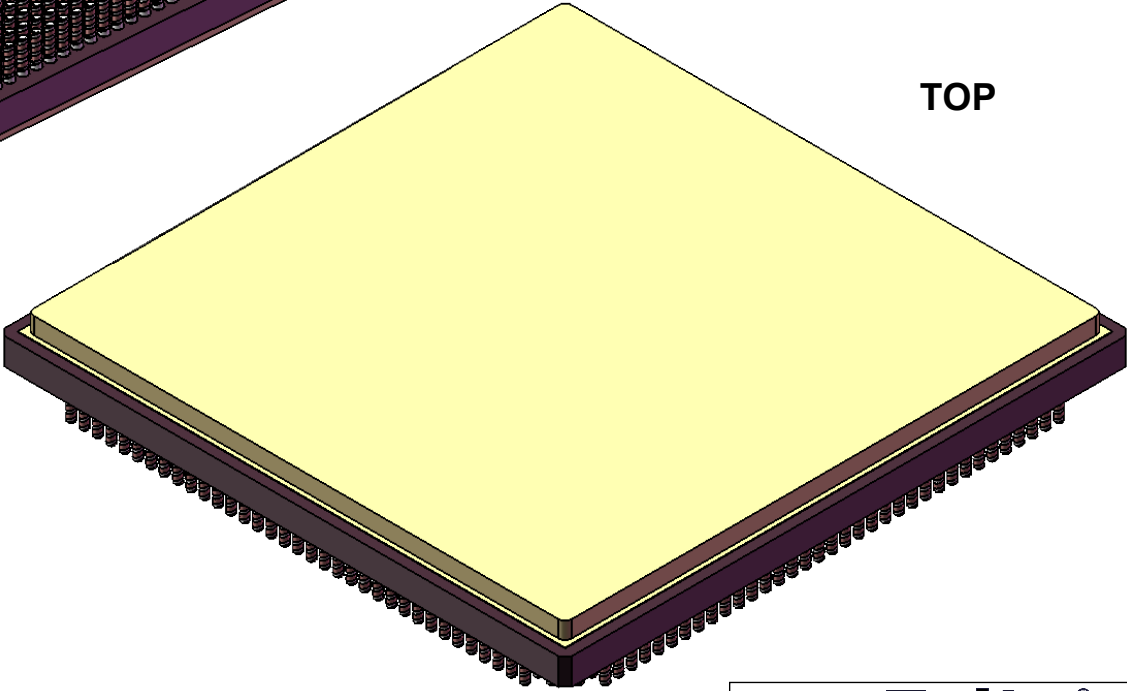

**TOP**

<b>TopLine®</b>			
TITLE CCGA1657T1.0-DC416D DUMMY COLUMN GRID ARRAY			
SCALE	SIZE	DRAWING NO.	REV
2.5:1	A	160193	A
DO NOT SCALE DRAWING			SHEET 7 OF 7