

### BOTTOM VIEW

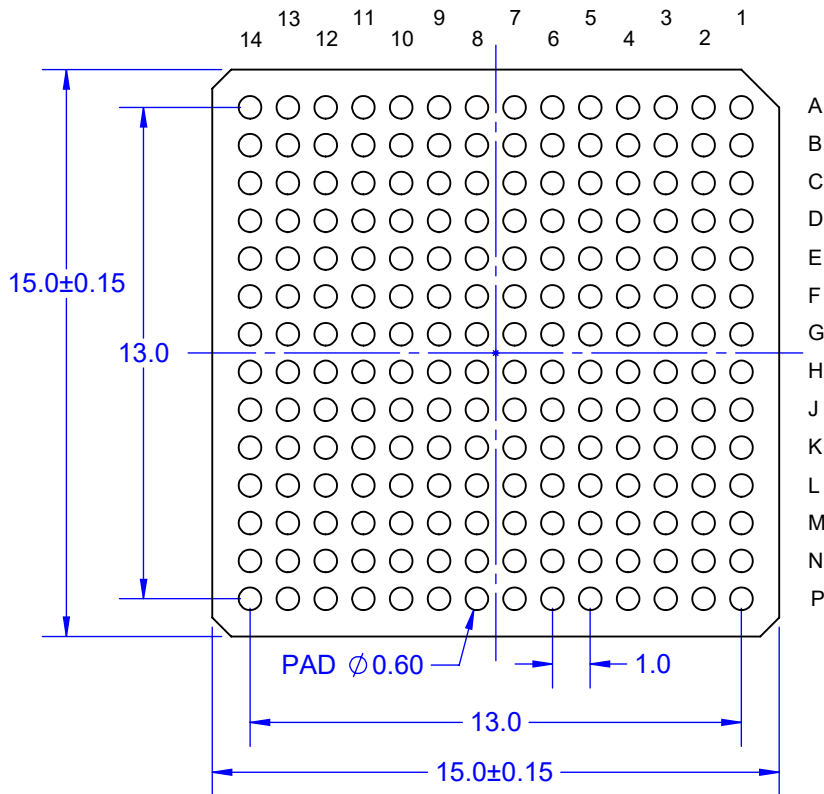

### SIDE VIEW

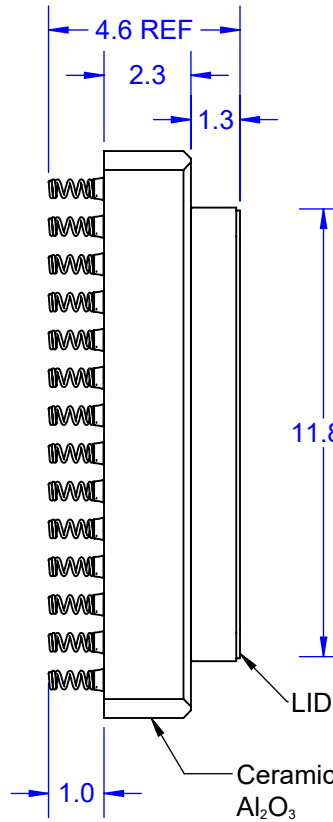

### TOP VIEW

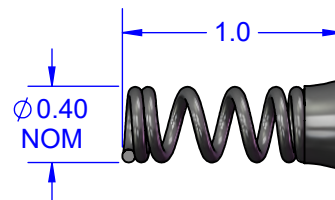
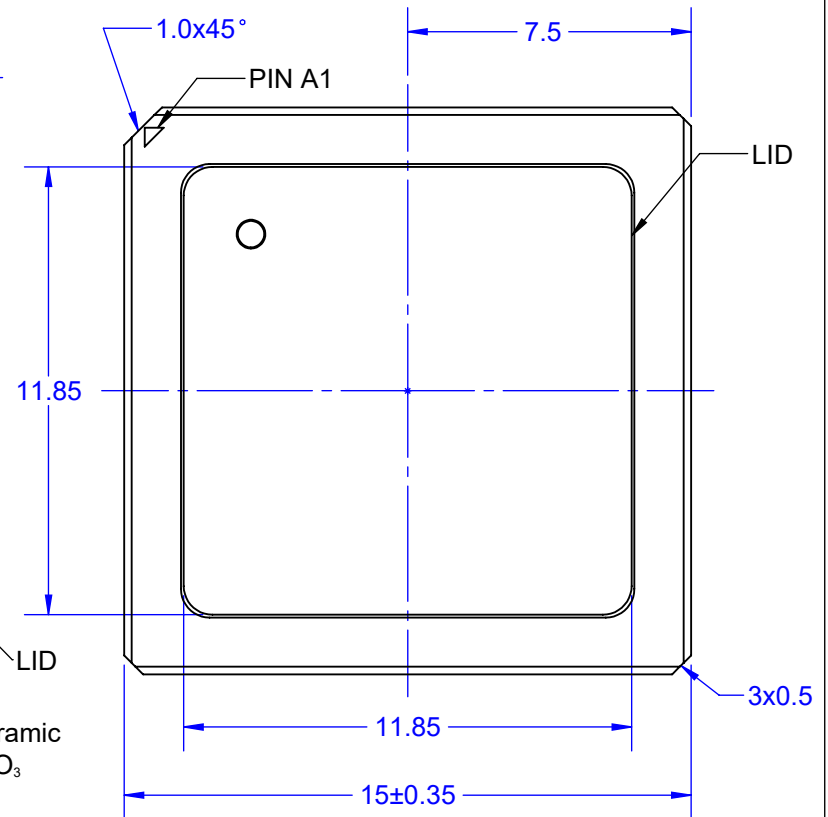

MICRO-COIL SPRING

Notes: (Unless Otherwise Specified).

- 1) DIMENSIONS mm.
- 2) SHOWN WITH COLUMNS.
- 3) SHOWN WITH LID COVER ATTACHED.

PART NUMBER OPTIONS			
PART NUMBER	DUMMY DIE	SOLDER PIN	LID
CCGA196T1.0M-DC149D	YES	YES	YES

APPROVALS	DATE	<b>TopLine®</b>		
DRAWN T.Au	8/23/2022			
ENG M. Hart	8/23/2022	TITLE CCGA196T1.0M-DC149D DAISY CHAIN COLUMN GRID ARRAY		
MFG		SCALE 5:1	SIZE A	DRAWING NO. 160078
QA				REV B
CUST				
REVISED		DO NOT SCALE DRAWING		SHEET 1 OF 5

# DAISY CHAIN PATTERN

## COLUMN (PAD) VIEW

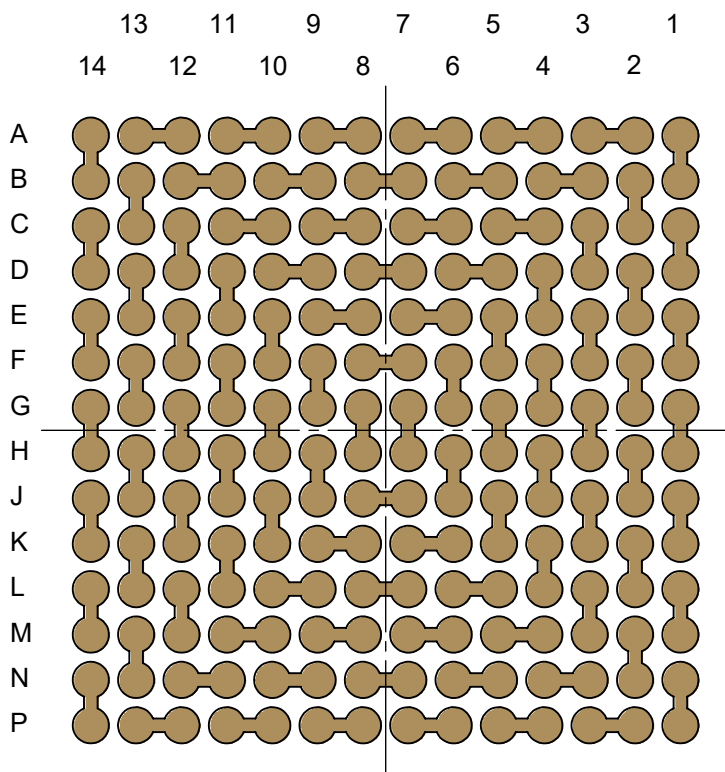

## BOTTOM X-RAY VIEWED FROM TOP

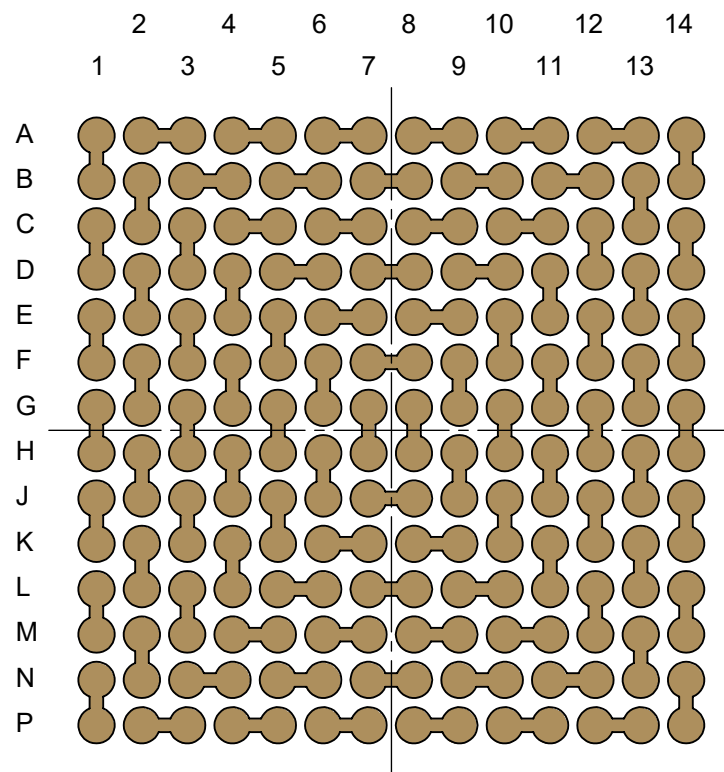

**TopLine®**

TITLE CCGA196T1.0M-DC149D  
DAISY CHAIN COLUMN GRID ARRAY

SCALE 2.5:1	SIZE A	DRAWING NO. 160078	REV B
----------------	-----------	-----------------------	----------

DO NOT SCALE DRAWING SHEET 2 OF 5

## DAISY CHAIN NET LIST

PIN	PIN
A1	B1
A2	A3
A4	A5
A6	A7
A8	A9
A10	A11
A12	A13
A14	B14
B2	C2
B3	B4
B5	B6
B7	B8
B9	B10
B11	B12
B13	C13
C1	D1
C3	D3
C4	C5
C6	C7
C8	C9
C10	C11
C12	D12
C14	D14
D2	E2
D4	E4

PIN	PIN
D5	D6
D7	D8
D9	D10
D11	E11
D13	E13
E1	F1
E3	F3
E5	F5
E6	E7
E8	E9
E10	F10
E12	F12
E14	F14
F2	G2
F4	G4
F6	G6
F7	F8
F9	G9
F11	G11
F13	G13
G1	H1
G3	H3
G5	H5
G7	H7
G8	H8

PIN	PIN
G10	H10
G12	H12
G14	H14
H2	J2
H4	J4
H6	J6
H9	J9
H11	J11
H13	J13
J1	K1
J3	K3
J5	K5
J7	J8
J10	K10
J12	K12
J14	K14
K2	L2
K4	L4
K6	K7
K8	K9
K11	L11
K13	L13
L1	M1
L3	M3
L5	L6

PIN	PIN
L7	L8
L9	L10
L12	M12
L14	M14
M2	N2
M4	M5
M6	M7
M8	M9
M10	M11
M13	N13
N1	P1
N3	N4
N5	N6
N7	N8
N9	N10
N11	N12
N14	P14
P2	P3
P4	P5
P6	P7
P8	P9
P10	P11
P12	P13

<b>TopLine®</b>			
TITLE CCGA196T1.0M-DC149D DAISY CHAIN COLUMN GRID ARRAY			
SCALE NONE	SIZE A	DRAWING NO. 160078	REV B
DO NOT SCALE DRAWING		SHEET 3 OF 5	

# SOLDER PIN OPTIONS

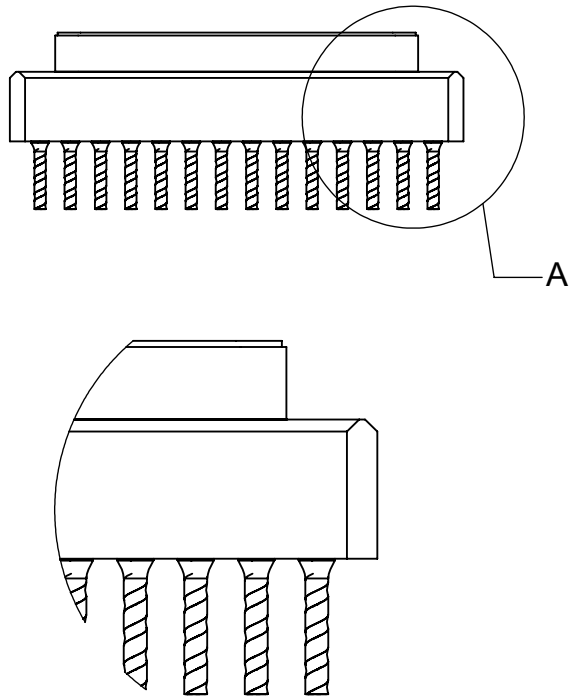

DETAIL A  
SCALE 8 : 1

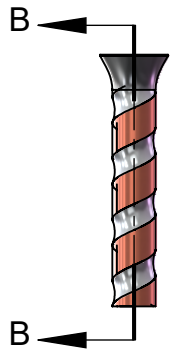

Pb80/Sn20  
Cu RIBBON  
SCALE 15:1

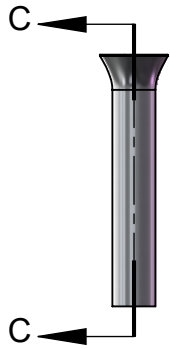

Pb90/Sn10  
SCALE 15:1

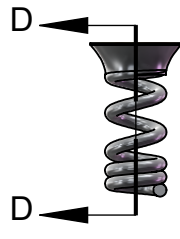

Micro-Coil  
Spring  
SCALE 20:1

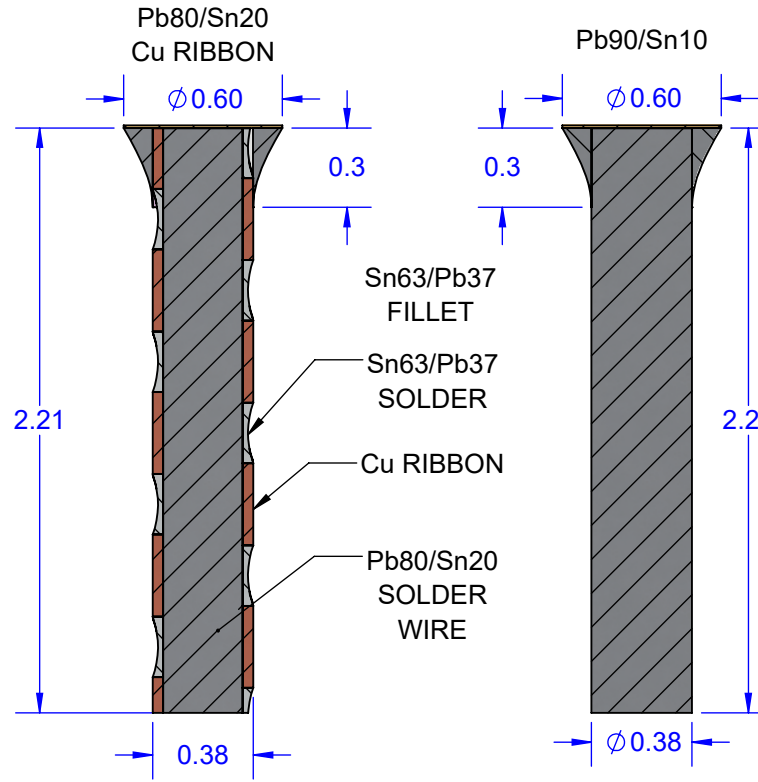

SECTION B-B  
SCALE 35 : 1

SECTION C-C  
SCALE 35 : 1

SECTION D-D  
SCALE 35 : 1

Ø 0.38  
COLUMN

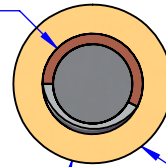

Ø 0.60  
PAD

Ø 0.38  
COLUMN

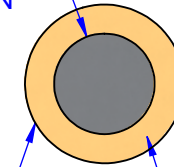

FILLET  
Ø 0.60 MIN

CLGA PAD  
Ø 0.60

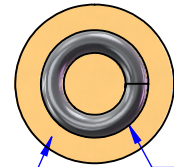

Ø 0.40  
SPRING

**TopLine**<sup>®</sup>

TITLE CCGA196T1.0M-DC149D  
DAISY CHAIN COLUMN GRID ARRAY

SCALE 4:1	SIZE A	DRAWING NO. 160078	REV B
--------------	-----------	-----------------------	----------

DO NOT SCALE DRAWING

SHEET 4 OF 5

**MODEL**  
**CCGA196T1.0M-DC149D**  
**MICRO-COIL SPRINGS**

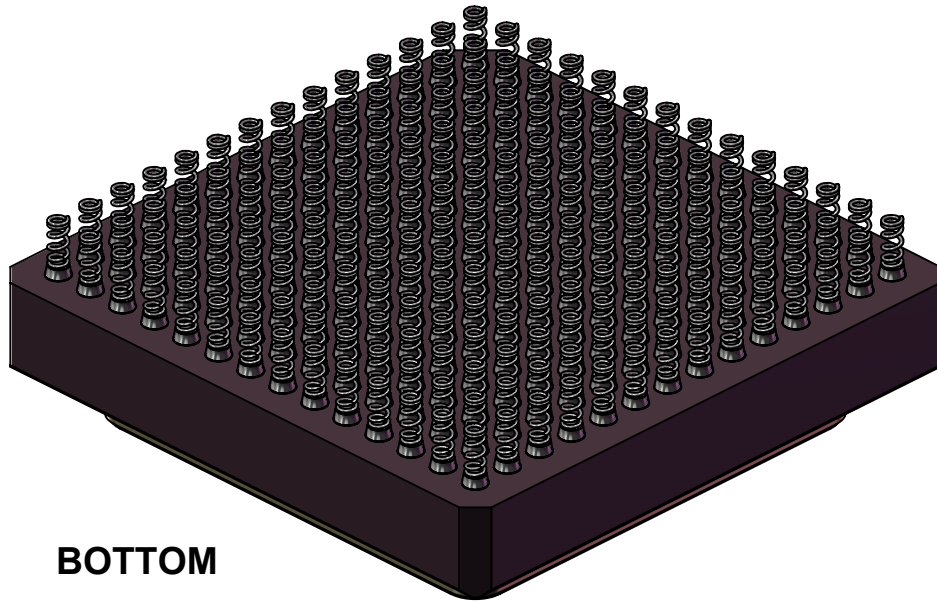

**BOTTOM**

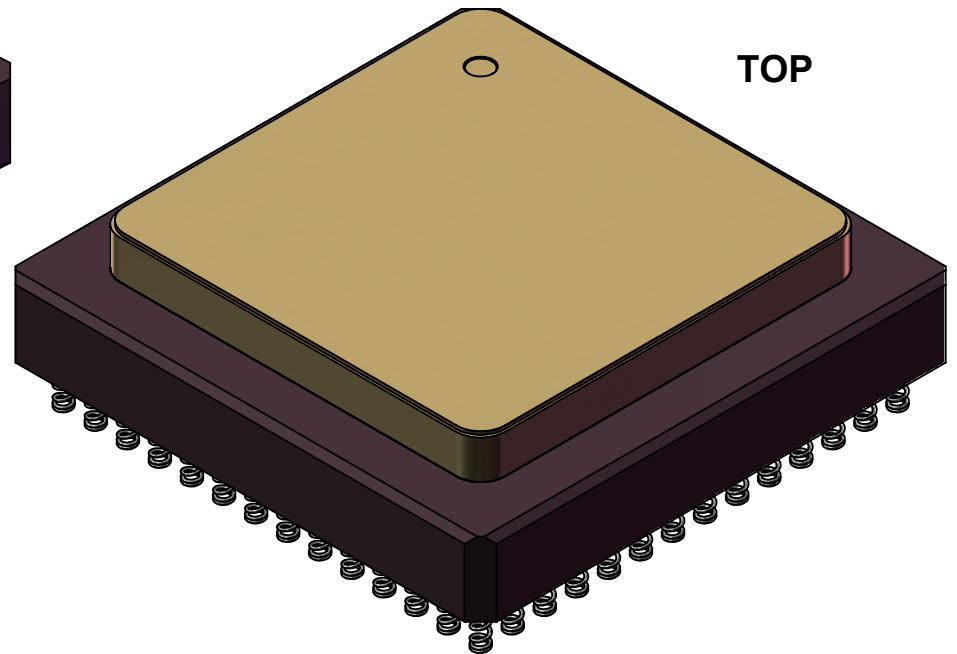

**TOP**

<b>TopLine®</b>			
TITLE CCGA196T1.0M-DC149D DAISY CHAIN COLUMN GRID ARRAY			
SCALE	SIZE	DRAWING NO.	REV
6:1	A	160078	B
DO NOT SCALE DRAWING			SHEET 5 OF 5