

6 CHCA J9K

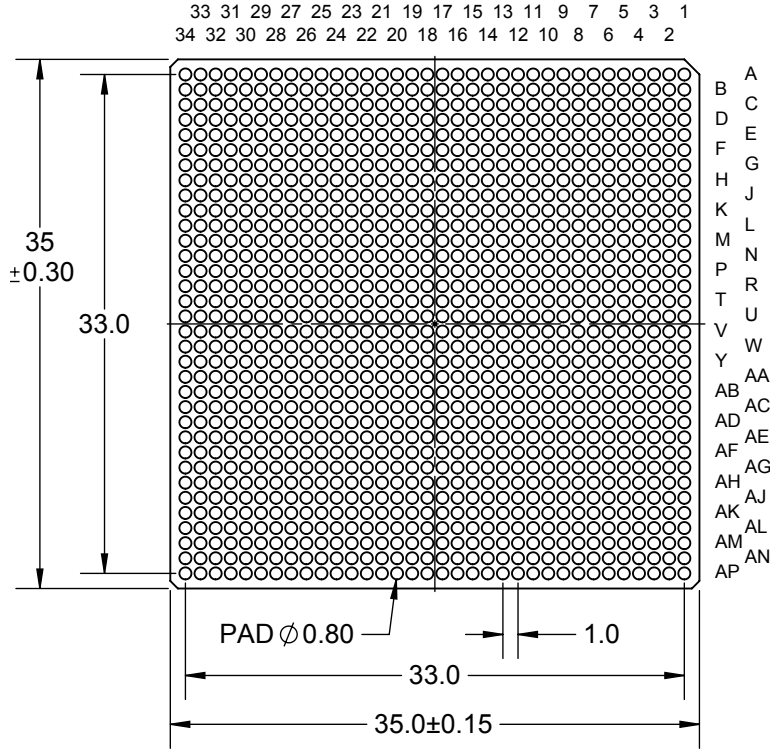

G89 J9K

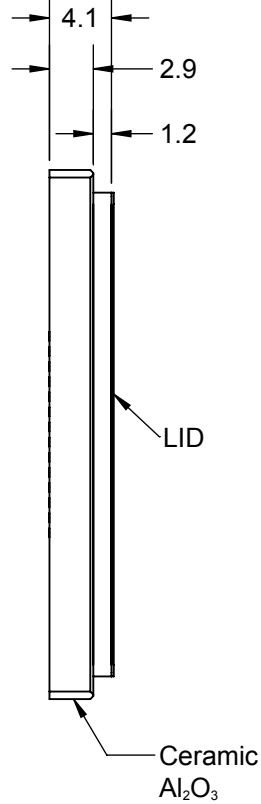

HCD J9K

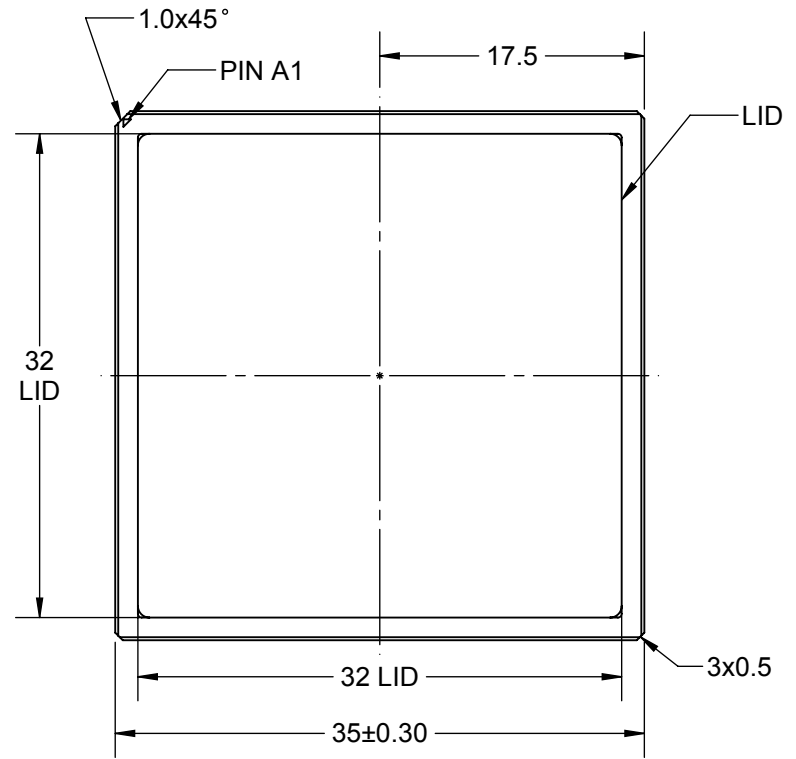

- Notes: (Unless Otherwise Specified).
 1) DIMENSIONS ARE IN mm.
 2) SHOWN WITHOUT COLUMNS.
 3) SHOWN WITH LID COVER ATTACHED.

D5FH'BI A69F'CDHCBG			
D5FH'BI A69F	89	GC @9F'D-B	@8
CLGA1156T1.0-DC349D	YES	NONE	YES

APPROVALS	DATE	TopLine®		
DRAWN T.Au	4/12/2020			
ENG M. Hart	4/12/2020	TITLE CLGA1156T1.0-DC349D LAND GRID ARRAY		
MFG		SCALE	SIZE	DRAWING NO.
QA		2:1	A	160139
CUST				REV A
REVISED		DO NOT SCALE DRAWING		SHEET 1 OF 3

8 5 -GM7 < 5 -B'D5 HH9 FB

7 C @ AB'fD5 8LJ-9K

6 CHHCA'L!F5 MJ-9K 98 : FCA'HCD

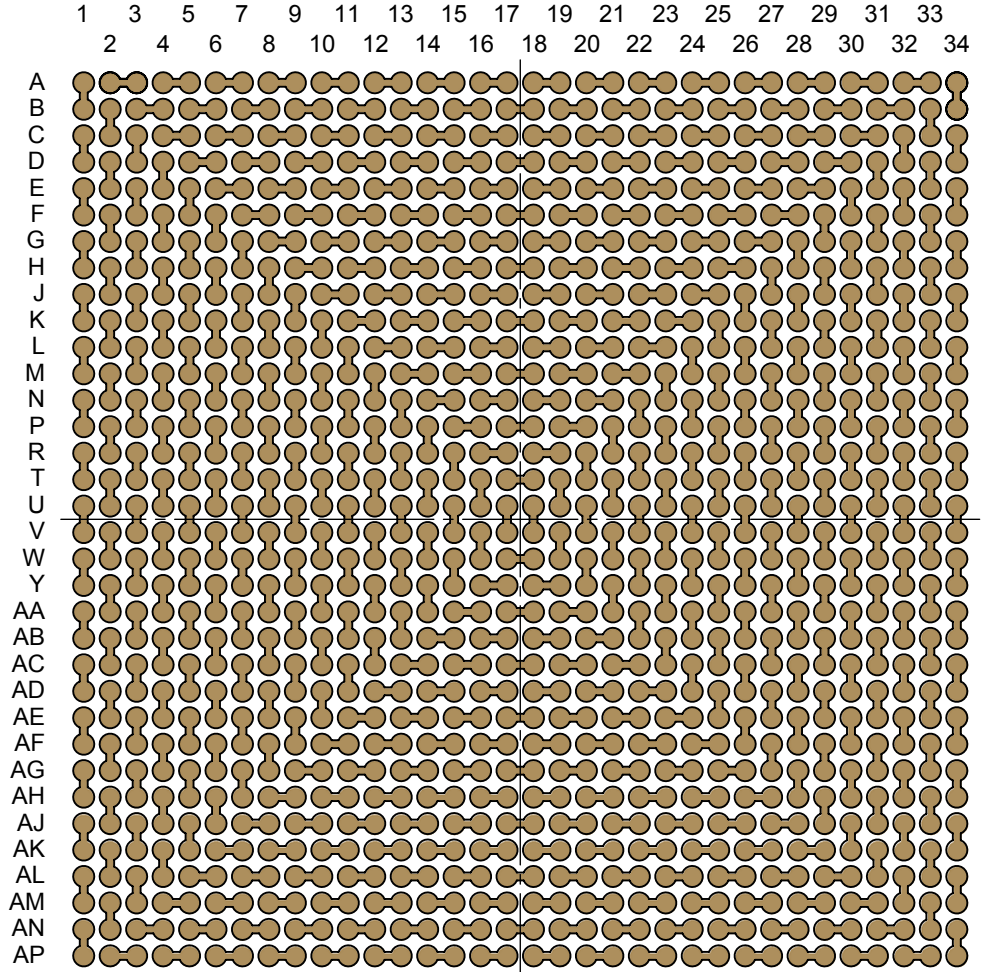
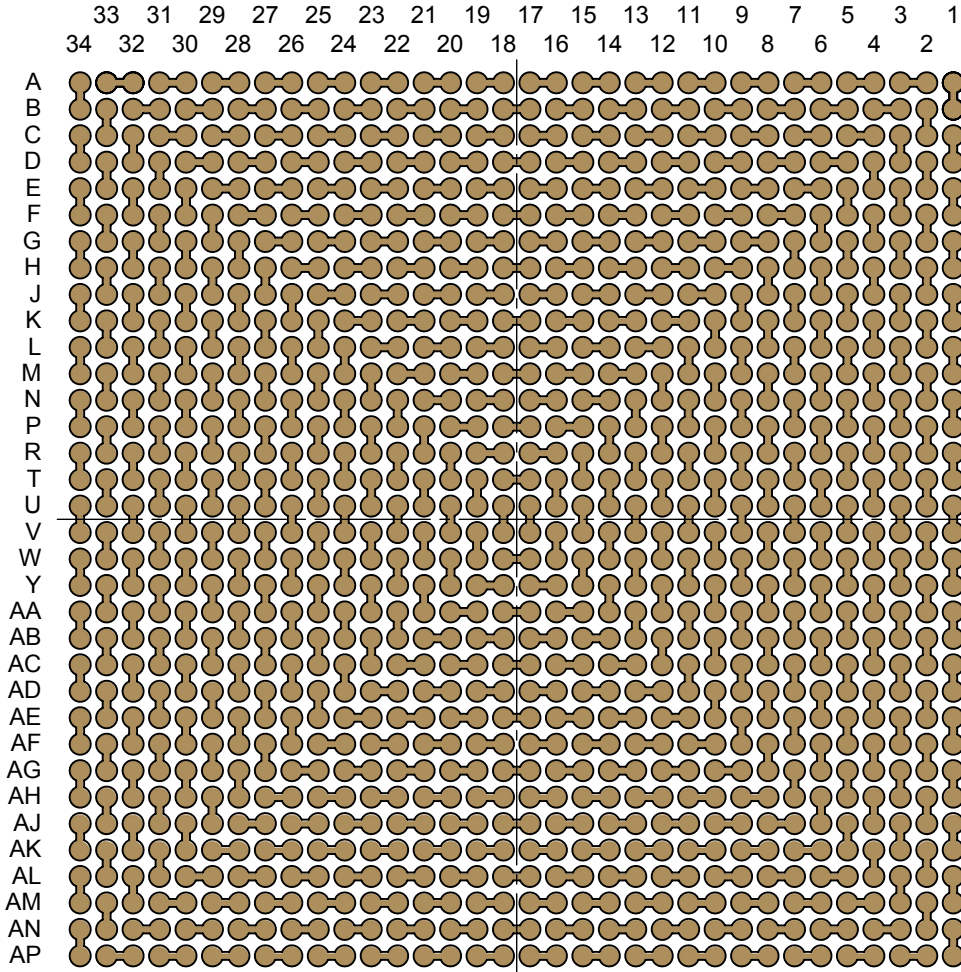

TITLE			
CLGA1156T1.0-DC349D LAND GRID ARRAY			
SCALE	SIZE	DRAWING NO.	REV
3.5:1	A	160139	A
DO NOT SCALE DRAWING			SHEET 2 OF 3

AC89@
7 @ 5% * H%\$!87' (-8
@8 '5 HH57 <98

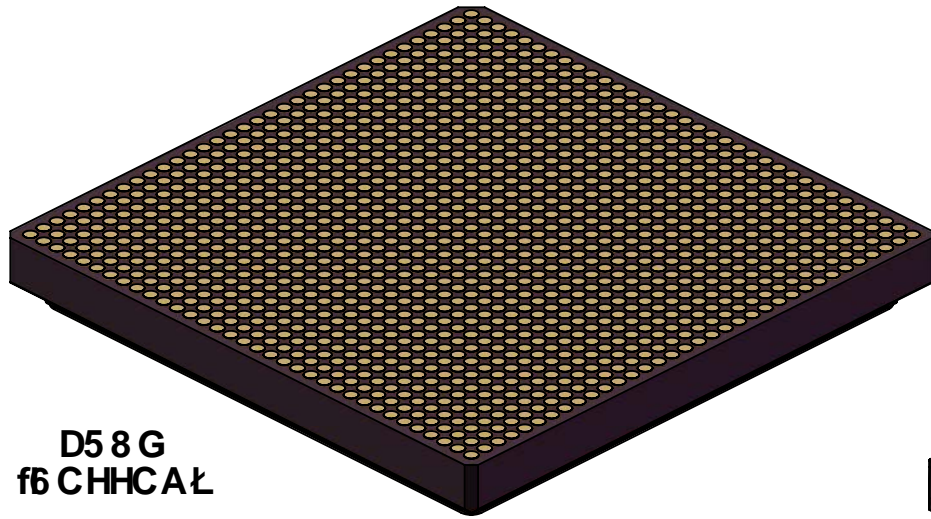

D5 8 G
f6 CHHCAŁ

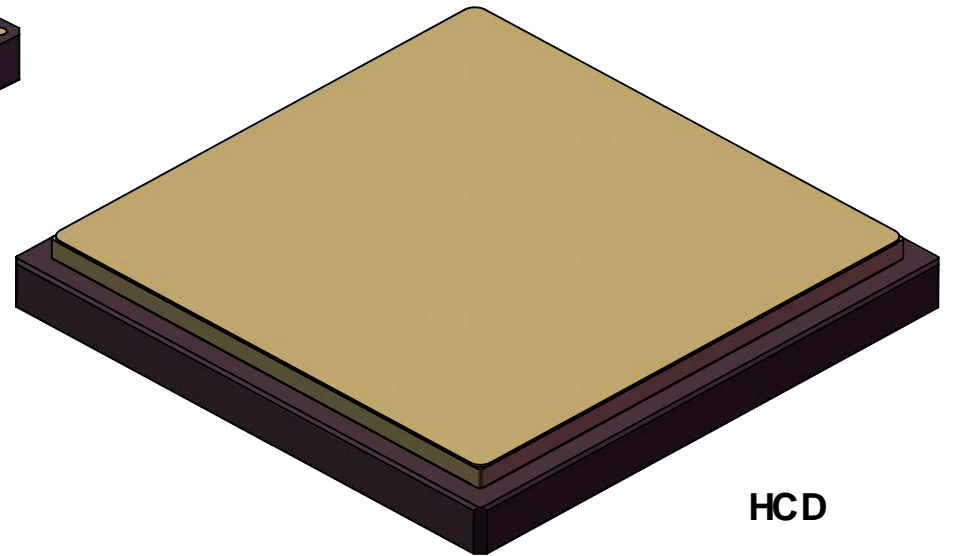

HCD

TopLine[®]

TITLE CLGA1156T1.0-DC349D
LAND GRID ARRAY

SCALE 2.5:1	SIZE A	DRAWING NO. 160139	REV A
----------------	-----------	-----------------------	----------

DO NOT SCALE DRAWING

SHEET 3 OF 3