

TOP VIEW

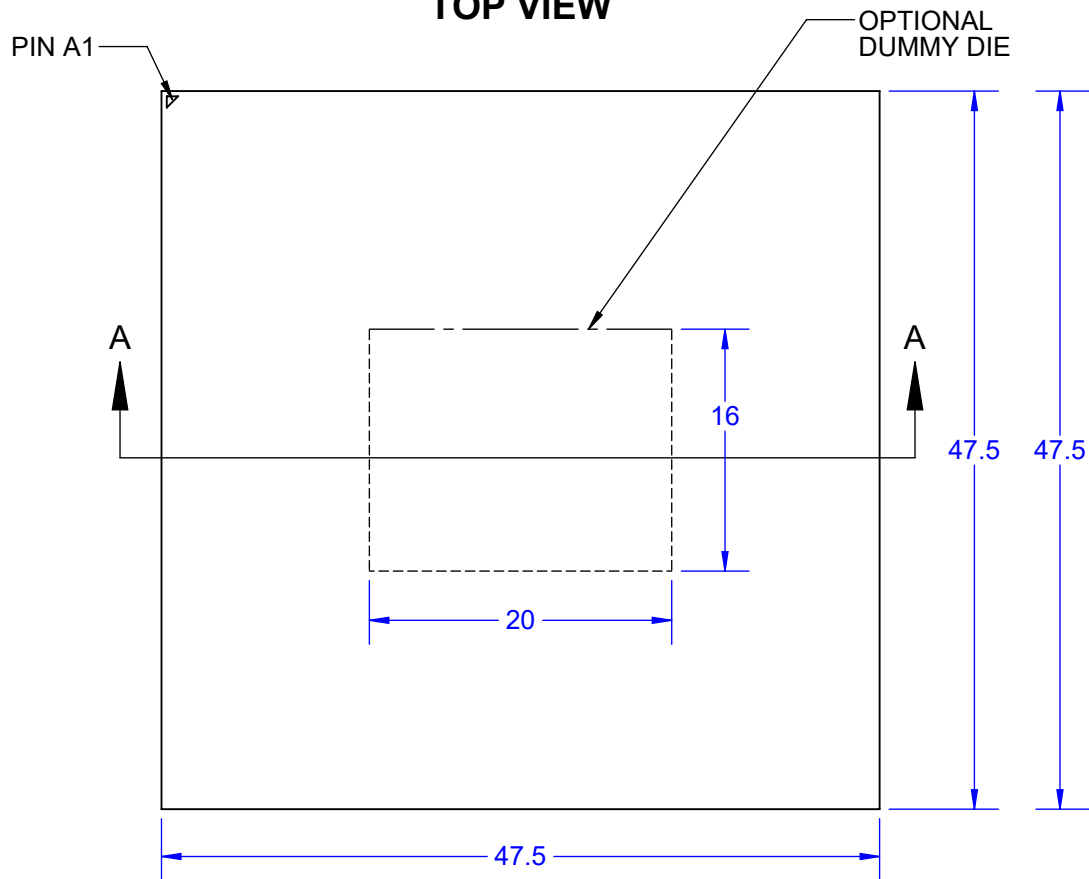

BALL VIEW

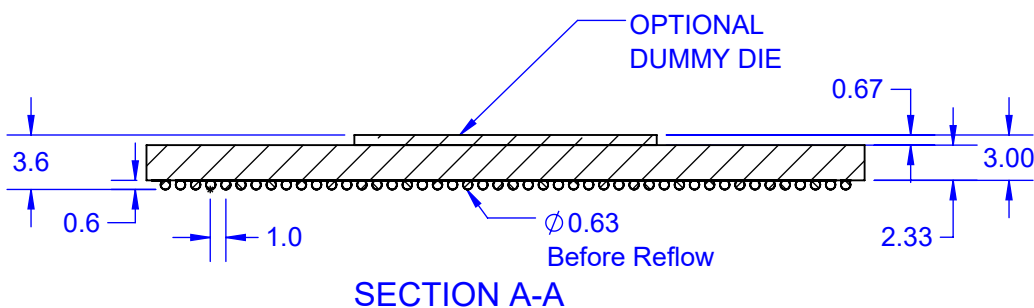
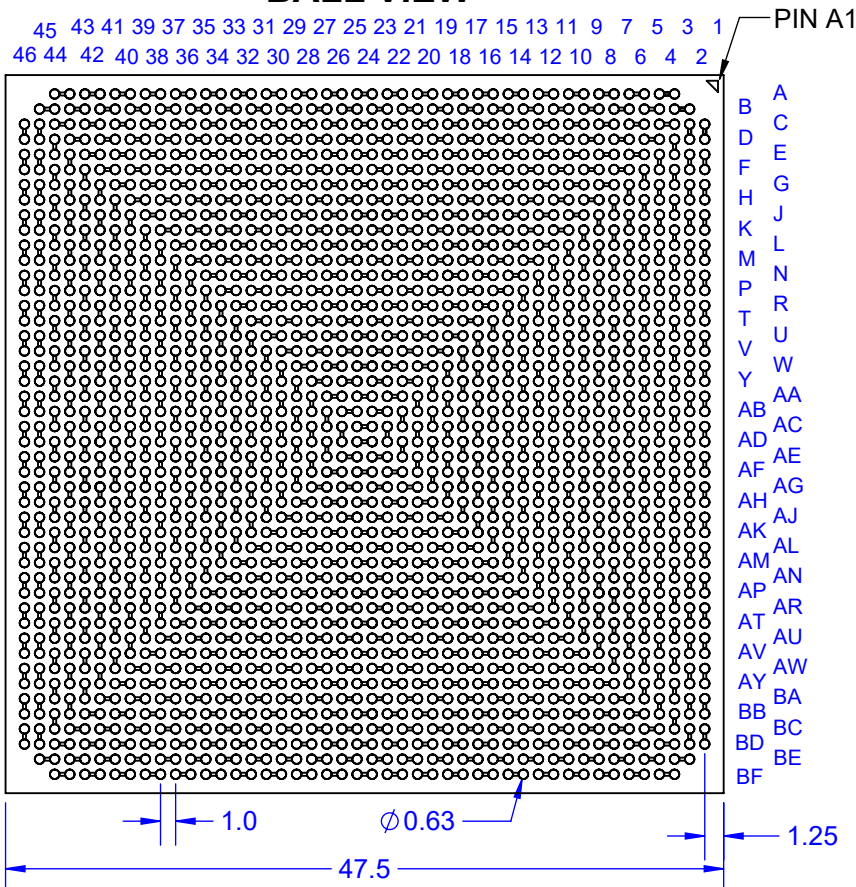

Notes: (Unless Otherwise Specified).

- 1) ALL DIMENSIONS ARE IN MM.
- 2) SOLDER BALL ALLOY: SEE PART NUMBER TABLE.
- 3) BALL DIAMETER (BEFORE REFLOW): 0.635mm (25 MIL).
- 4) SOLDER MASK DEFINED PAD OPENING: 0.508mm (20 MIL).
- 5) PAD Cu DIAMETER: 0.635mm (25 MIL).
- 6) SUBSTRATE MATERIAL: BT (ALTERNATE FR4 or Polyimide).
- 7) DUMMY DIE IS OPTIONAL.
- 8) DAISY CHAIN PATTERN (SEE PAGE 2).
- 9) MSL-3 RECOMMENDED BAKING 24 HOURS @ 125°C TO REMOVE MOISTURE PRIOR SOLDERING TO PC BOARD.

PART NUMBER TABLE

PART NUMBER	BALL ALLOY	BALL ALLOY	RoHS	Si DIE
LBGA2104T1.0C-DC467D	Sn96.5/Ag3.0/Cu0.5	SAC305	YES	YES
LBGA2104T1.0C-DC467	Sn96.5/Ag3.0/Cu0.5	SAC305	YES	NO
LBGA2104T1.0-DC467D	Sn63/Pb37	Sn63	NO	YES
LBGA2104T1.0-DC467	Sn63/Pb37	Sn63	NO	NO

APPROVALS	DATE				
DRAWN T.Au	1/10/2021				
ENG M. Hart	1/10/2021	TITLE LBGA2104T1.0C-DC467D DAISY CHAIN DUMMY			
MFG		SCALE	SIZE	DRAWING NO.	REV
QA		2:1	A	514671	A
CUST		DO NOT SCALE DRAWING			SHEET 1 OF 9
REVISED					

BALL VIEW

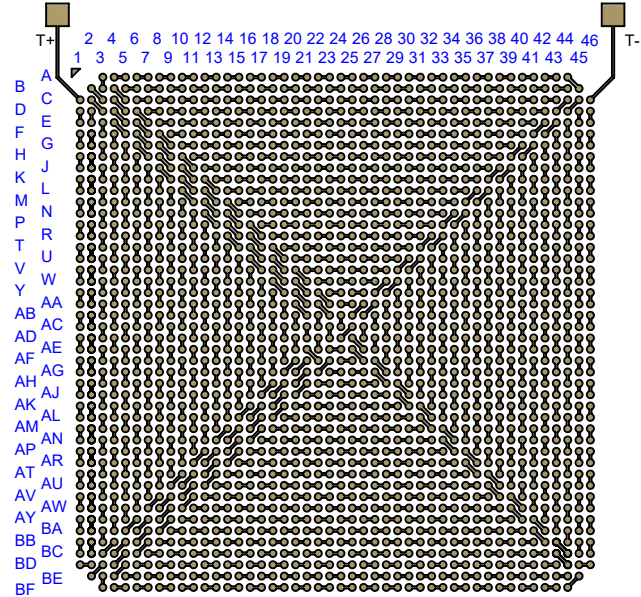
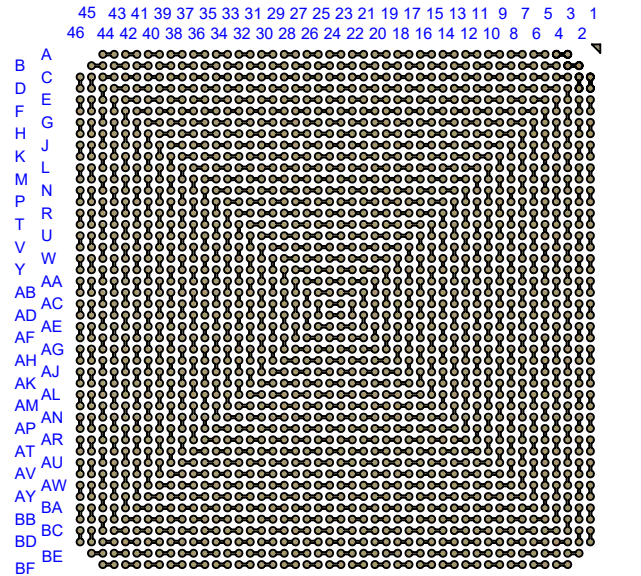

TEST VEHICLE BOARD

BOTTOM SIDE (TOP X-RAY VIEW)

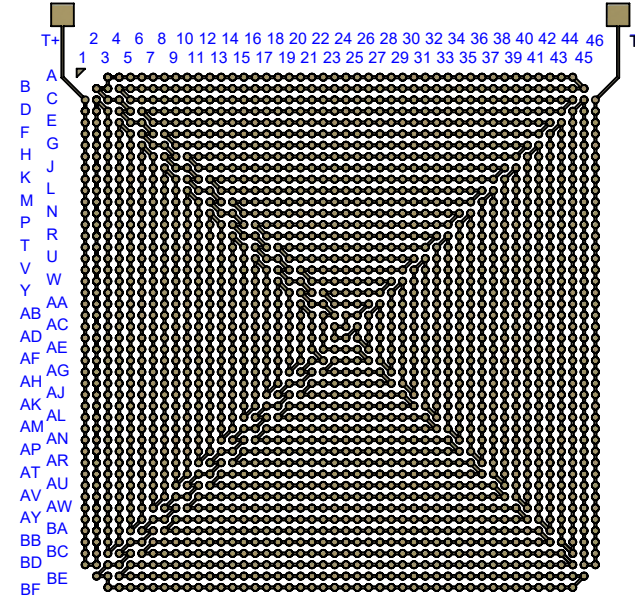
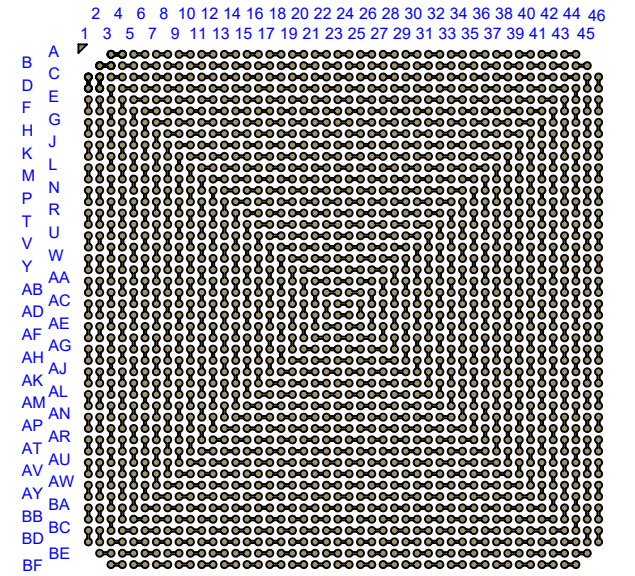

AFTER MOUNTING

- Notes:
- 1) PCB BOARD DIMENSIONS ARE PRESENTD ONLY AS A GUIDELINE. DESIGNERS SHOULD USE THEIR OWN EXPERIENCE WHEN DESIGNING PCB.
 - 2) PCB Cu BALL PAD DIAMETER 0.635mm [25 MIL].
 - 3) PCB DAISY CHAIN TRACING LINE WIDTH 0.204mm [8 MIL].
 - 4) SMD (SOLDER MASK DEFINED) PAD OPENING 0.508mm [20 MIL].

TopLine®			
TITLE		LBGA2104T1.0C-DC467D DAISY CHAIN DUMMY	
SCALE	SIZE	DRAWING NO.	REV
3:2	A	514671	A
DO NOT SCALE DRAWING			SHEET 2 OF 9

BALL VIEW

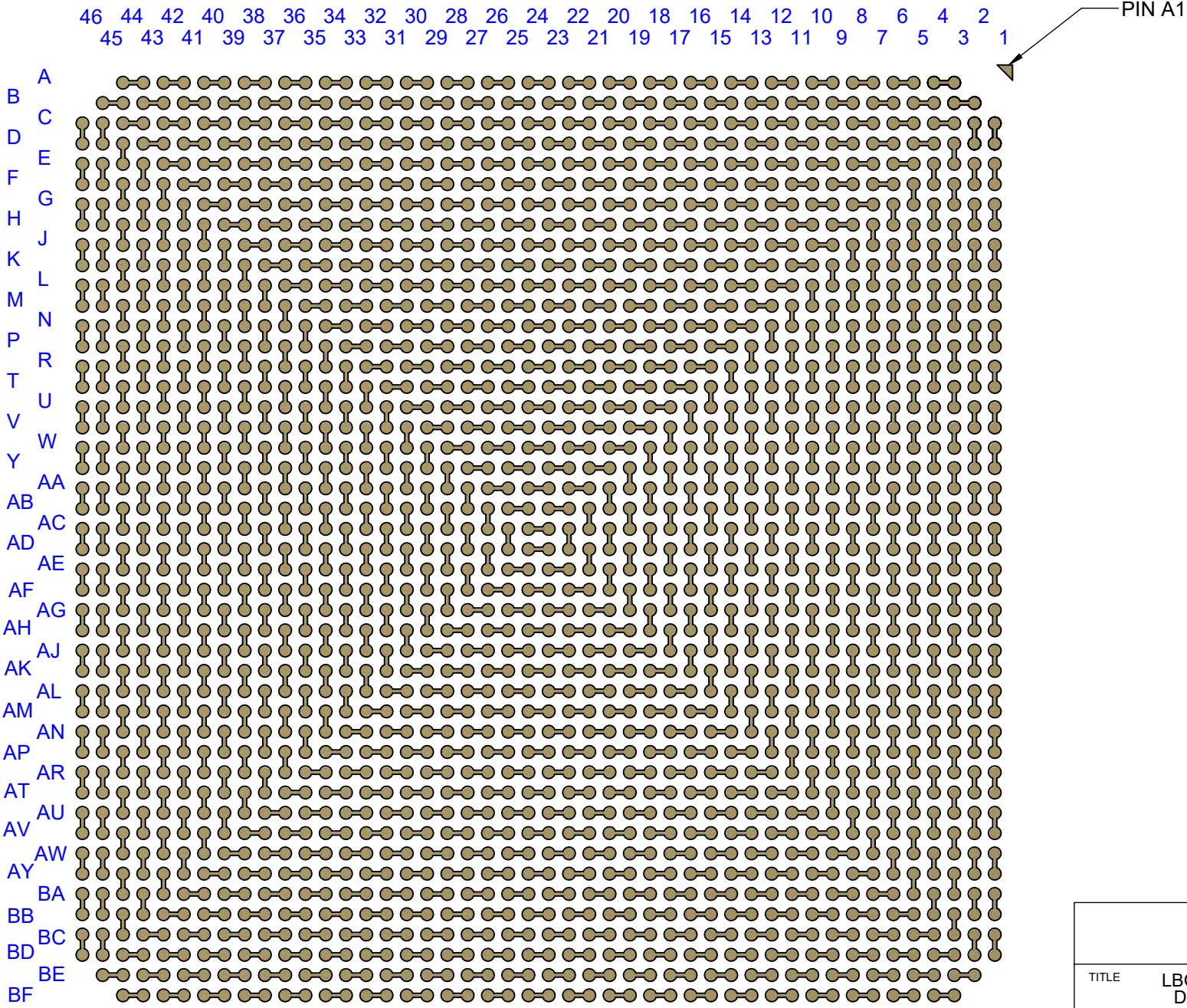

TopLine®			
TITLE LPGA2104T1.0C-DC467D DAISY CHAIN DUMMY			
SCALE	SIZE	DRAWING NO.	REV
3.5:1	A	514671	A
DO NOT SCALE DRAWING			SHEET 3 OF 9

BOTTOM SIDE (TOP X-RAY VIEW)

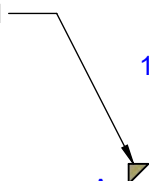
PIN A1 

1 3 5 7 9 11 13 15 17 19 21 23 25 27 29 31 33 35 37 39 41 43 45
2 4 6 8 10 12 14 16 18 20 22 24 26 28 30 32 34 36 38 40 42 44 46



TopLine®			
TITLE LBG2104T1.0C-DC467D DAISY CHAIN DUMMY			
SCALE	SIZE	DRAWING NO.	REV
3.5:1	A	514671	A
DO NOT SCALE DRAWING			SHEET 4 OF 9

TEST VEHICLE BOARD

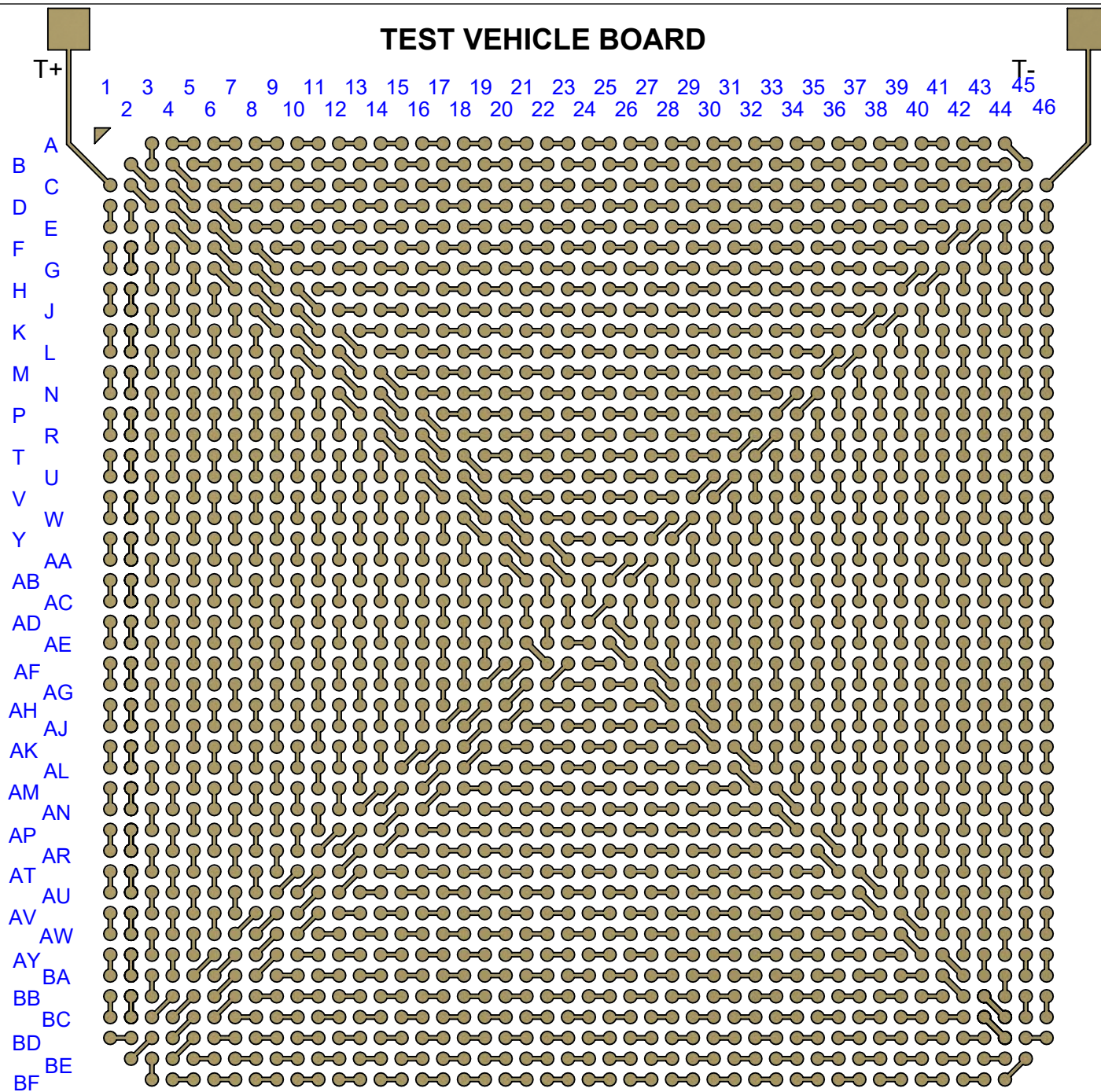

Notes:

- 1) PCB BOARD DIMENSIONS ARE PRESENTD ONLY AS A GUIDELINE. DESIGNERS SHOULD USE THEIR OWN EXPERIENCE WHEN DESIGNING PCB.
- 2) PCB Cu BALL PAD DIAMETER 0.635mm [25 MIL].
- 3) PCB DAISY CHAIN TRACING LINE WIDTH 0.204mm [8 MIL].
- 4) SMD (SOLDER MASK DEFINED) PAD OPENING 0.508mm [20 MIL].

TopLine®			
TITLE LPGA2104T1.0C-DC467D DAISY CHAIN DUMMY			
SCALE 3.5:1	SIZE A	DRAWING NO. 514671	REV A
DO NOT SCALE DRAWING			SHEET 5 OF 9

AFTER MOUNTING

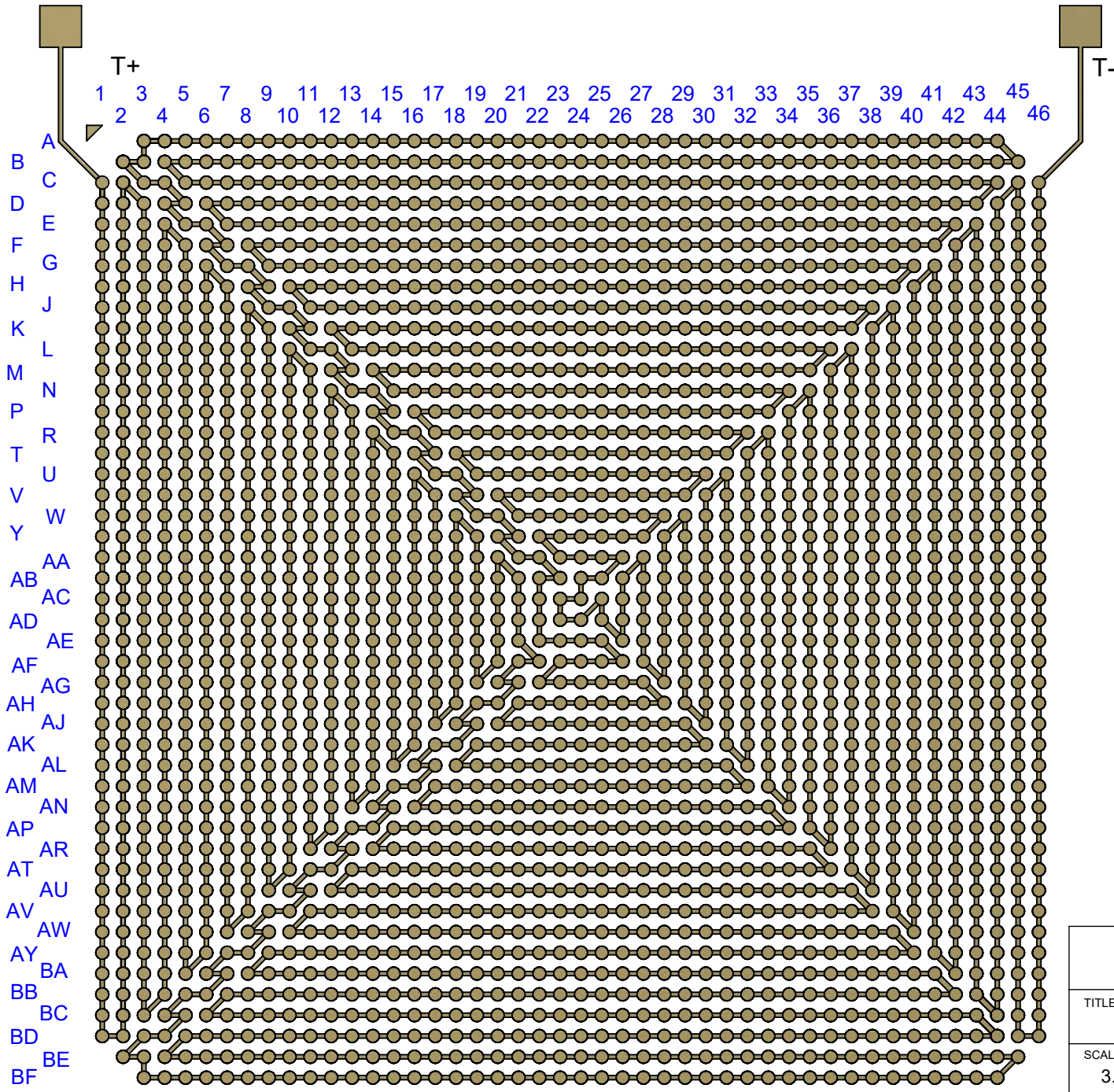

TopLine®			
TITLE LBG2104T1.0C-DC467D DAISY CHAIN DUMMY			
SCALE	SIZE	DRAWING NO.	REV
3.5:1	A	514671	A
DO NOT SCALE DRAWING			SHEET 6 OF 9

**MODEL
WITH DIE**

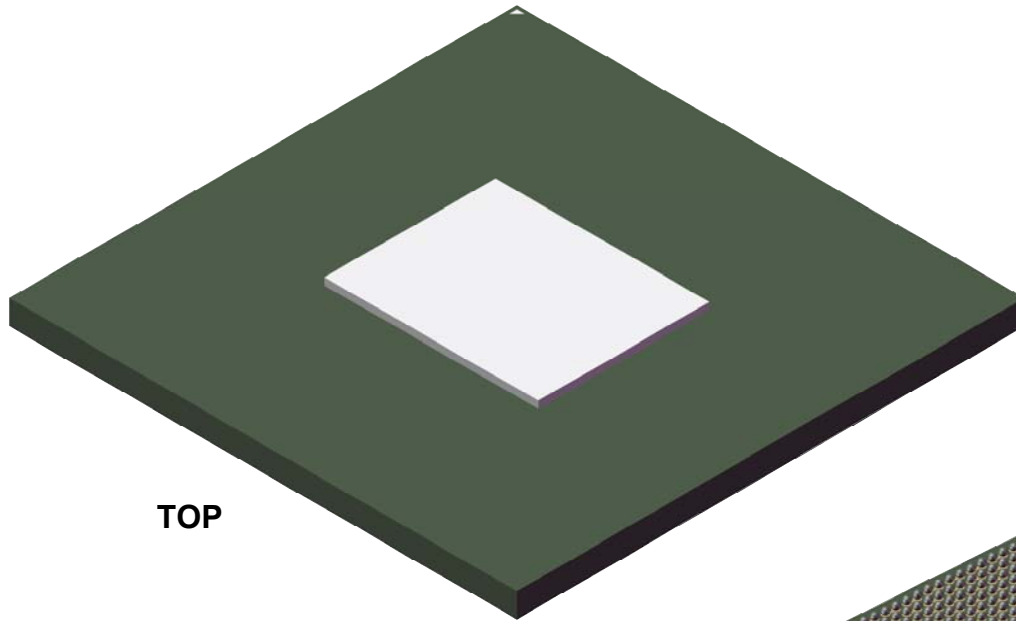

TOP

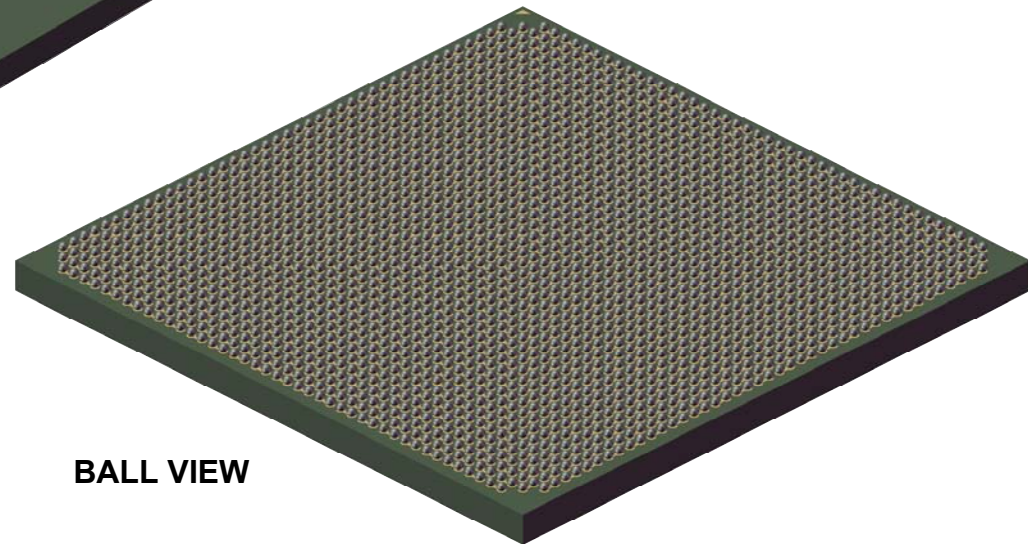

BALL VIEW

TopLine®

TITLE LPGA2104T1.0C-DC467D
DAISY CHAIN DUMMY

SCALE 2:1	SIZE A	DRAWING NO. 514671	REV A
--------------	-----------	-----------------------	----------

DO NOT SCALE DRAWING

SHEET 7 OF 9

**MODEL
WITHOUT DIE**

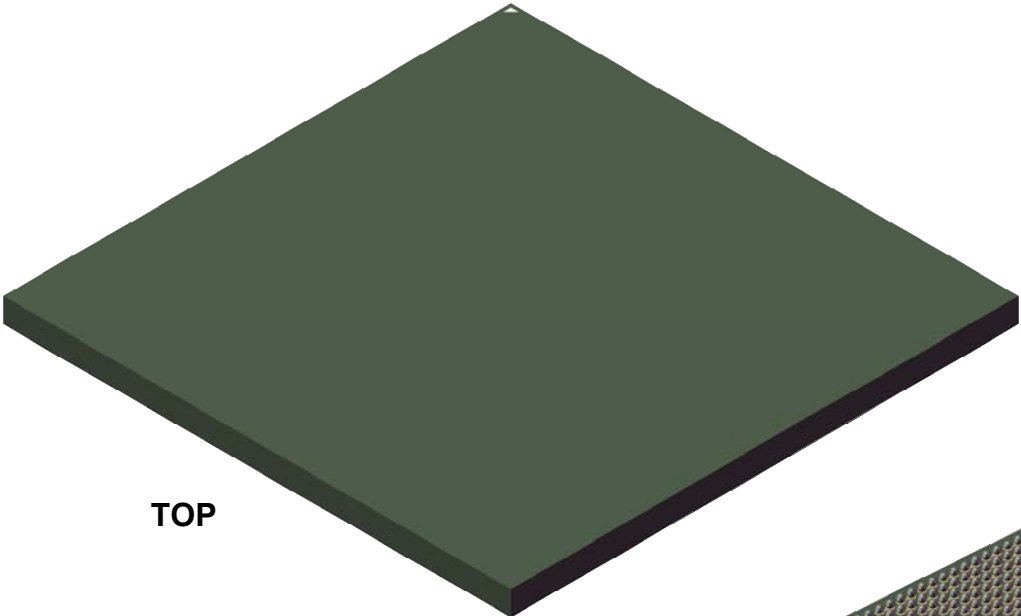

TOP

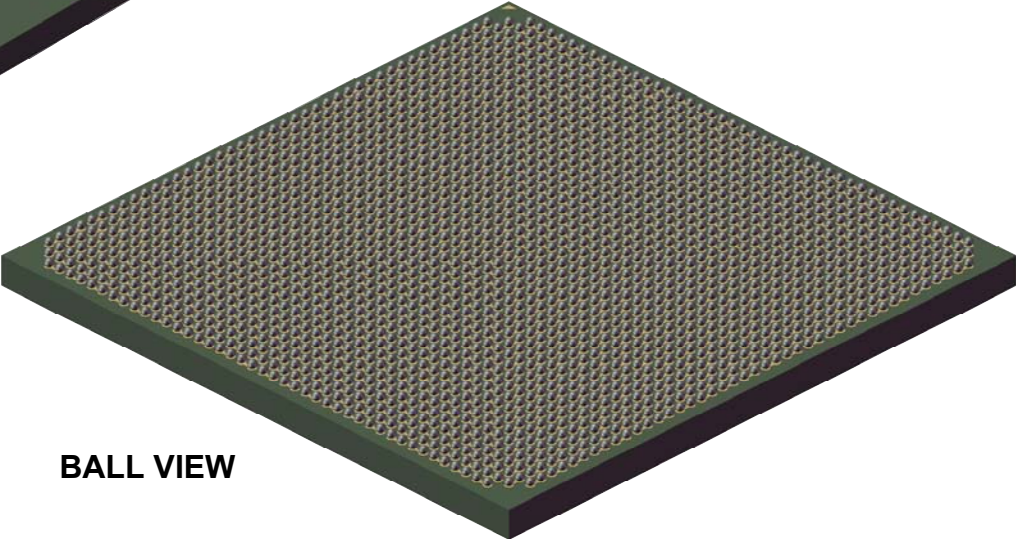

BALL VIEW



TITLE LPGA2104T1.0C-DC467D
DAISY CHAIN DUMMY

SCALE 2:1	SIZE A	DRAWING NO. 514671	REV A
--------------	-----------	-----------------------	----------

BOTTOM SOLDER MASK (RIGHT READING)

46 44 42 40 38 36 34 32 30 28 26 24 22 20 18 16 14 12 10 8 6 4 2
45 43 41 39 37 35 33 31 29 27 25 23 21 19 17 15 13 11 9 7 5 3 1

A
B
C
D
E
F
G
H
J
K
L
M
N
P
R
T
U
V
W
Y
AA
AB
AC
AD
AE
AF
AG
AH
AJ
AK
AL
AM
AN
AP
AR
AT
AU
AV
AW
AY
BA
BB
BC
BD
BE
BF

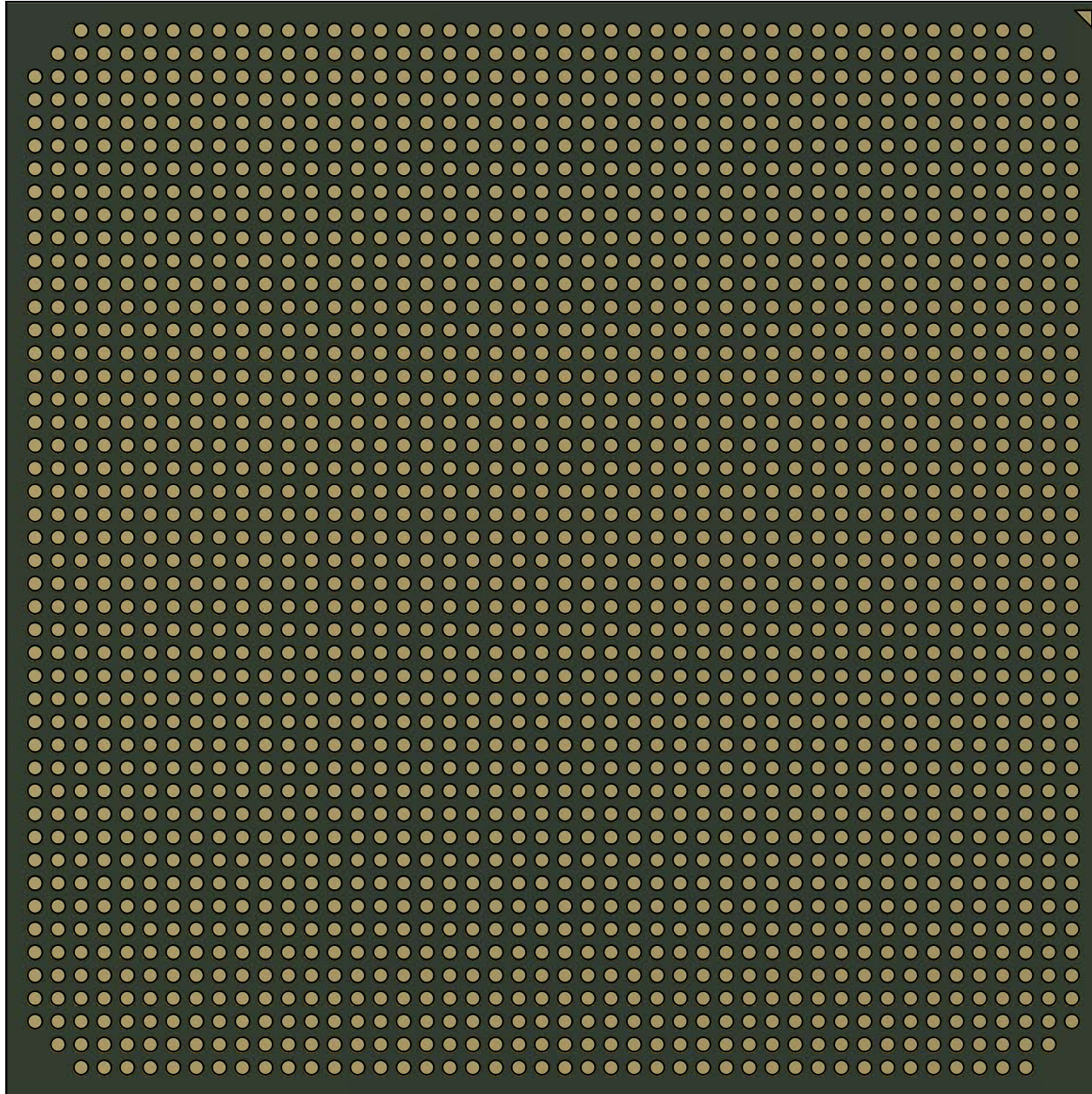

TopLine®			
TITLE SBGA2104T1.0-DC467D DAISY CHAIN DUMMY			
SCALE 3.75:1	SIZE A	DRAWING NO. 514676	REV A
DO NOT SCALE DRAWING			SHEET 9 OF 9