

TOP VIEW

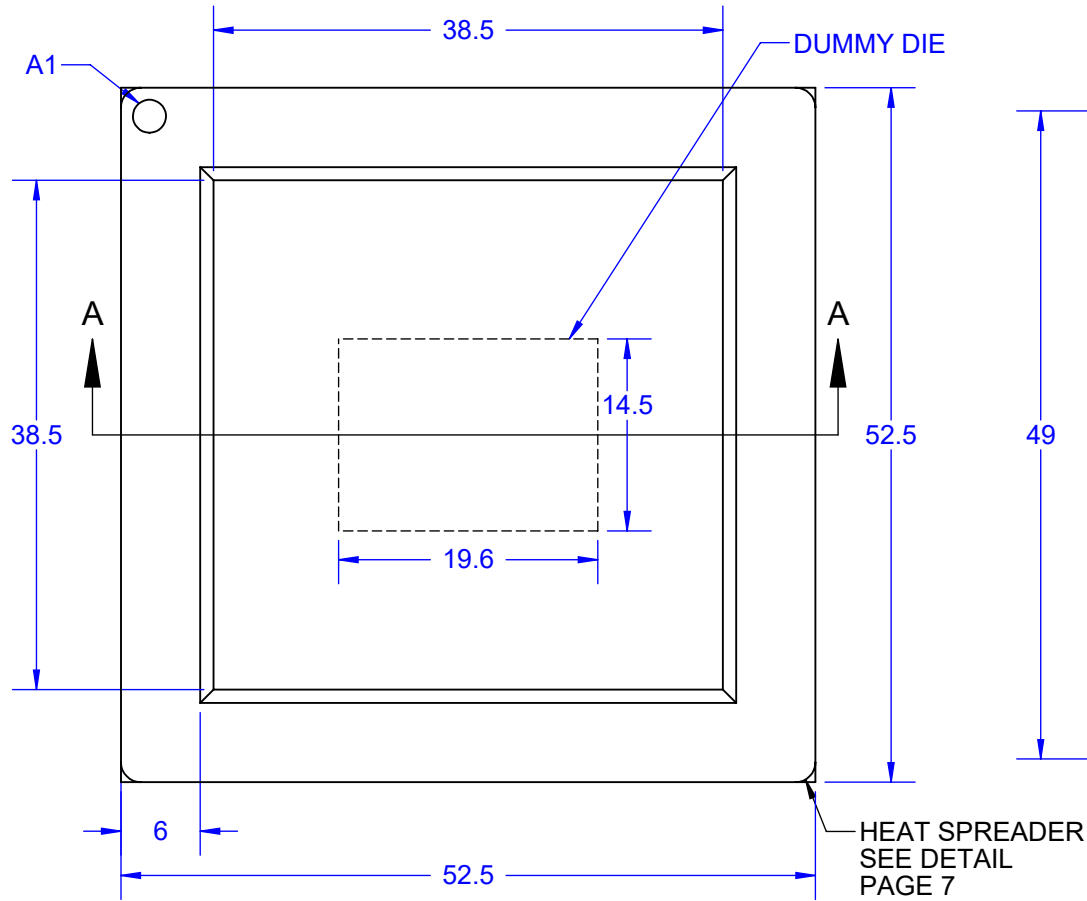

BALL VIEW

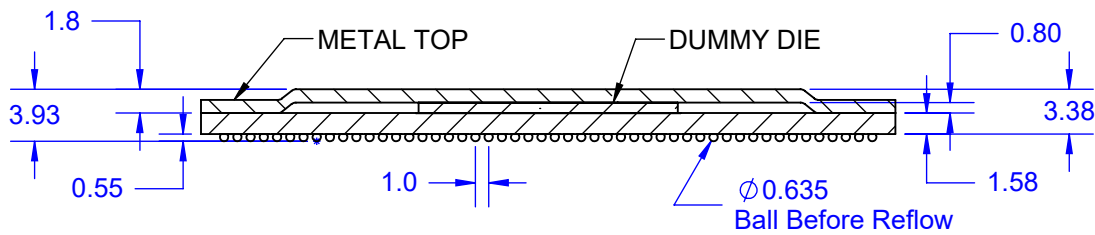
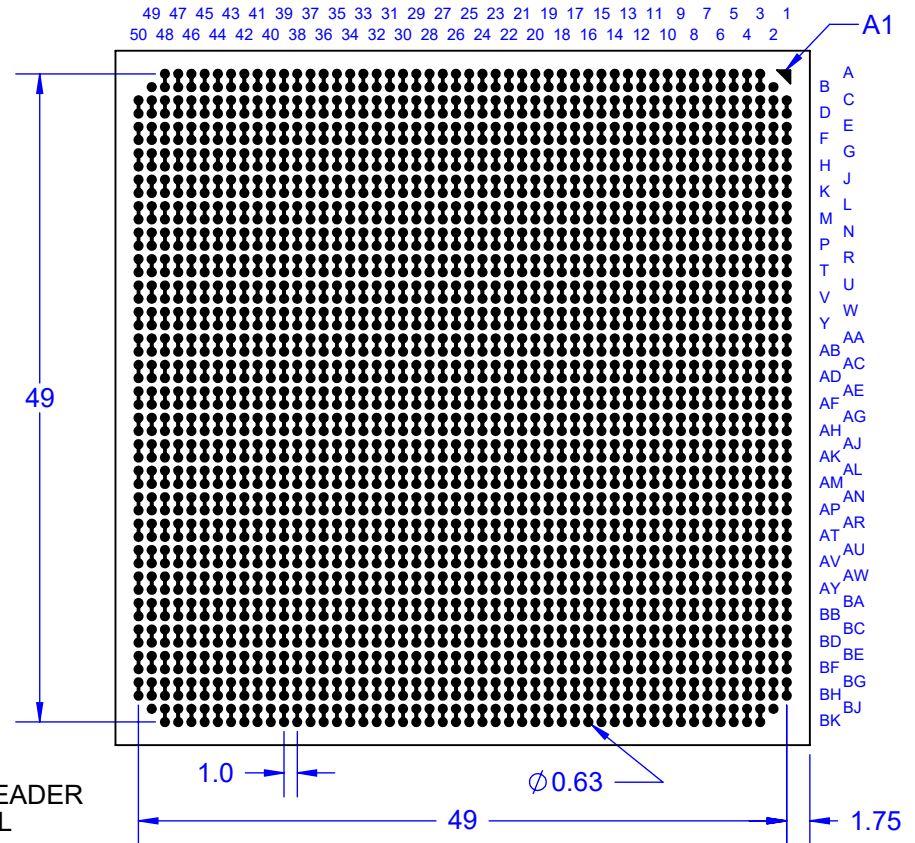

SECTION A-A

NOTES: (Unless Otherwise Specified).

- 1) ALL DIMENSIONS ARE IN MM.
- 2) SOLDER BALL ALLOY: SEE PART NUMBER TABLE.
- 3) BALL DIAMETER (BEFORE REFLOW) 0.635mm [25mil].
- 4) SOLDER MASK DEFINED PAD OPENING: 0.505mm [20mil].
- 5) PAD Cu DIAMETER: 0.635 [0.25mil].
- 6) SUBSTRATE MATERIAL: FR4.
- 7) DUMMY DIE: Si (SILICON).
- 8) DAISY CHAIN PATTERN (SEE PAGE 2).
- 9) MSL-3 RECOMMENDED BAKING 24 HOURS @ 125°C TO REMOVE MOISTURE PRIOR TO SOLDERING TO PC BOARD.

PART NUMBER TABLE

PART NUMBER	BALL METAL	BALL ALLOY	RoHS	Si DIE
SBGA2488T1.0C-DC507D	Sn96.5/Ag3.0/Cu0.5	SAC305	YES	YES
SBGA2488T1.0-DC507D	Sn63/Pb37	Sn63	NO	YES

APPROVALS	DATE				
DRAWN T. Au	10/18/16				
ENG M. Hart	10/18/16	TITLE SBGA2488T1.0C-DC507D DAISY CHAIN DUMMY			
MFG		SCALE 1.75:1	SIZE A	DRAWING NO. 515070	REV A
QA		DO NOT SCALE DRAWING			SHEET 1 OF 12
CUST					
REVISED					

BALL VIEW

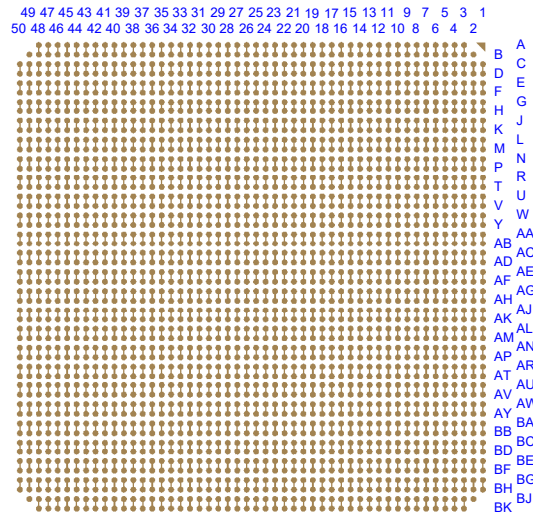

BOTTOM SIDE (TOP X-RAY VIEW)

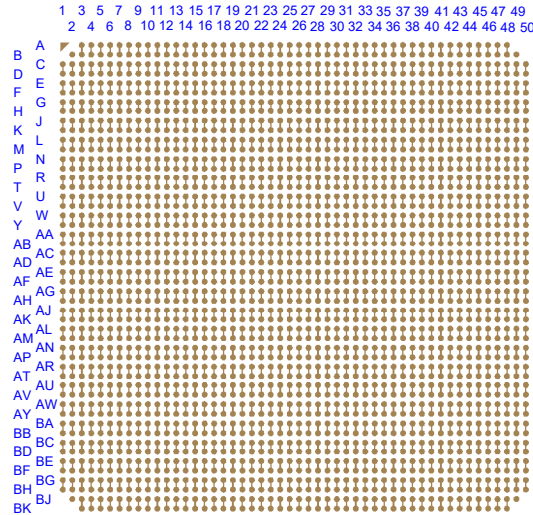

A

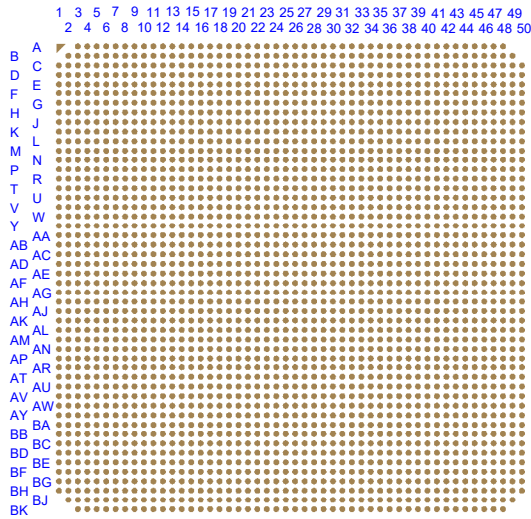

TEST VEHICLE BOARD UNDER DEVELOPMENT

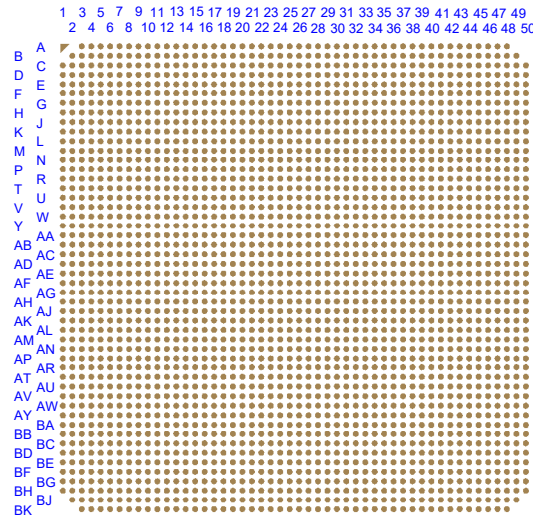

TEST VEHICLE BOARD UNDER DEVELOPMENT

NOTES: (Unless Otherwise Specified).

- 1) PCB BOARD DIMENSIONS ARE PRESENTED ONLY AS A GUIDELINE DESIGNERS SHOULD USE THEIR OWN KNOWLEDGE WHEN DESIGNING THE PCB.
- 2) PCB Cu BALL PAD DIAMETER: 0.635 [25mil].
- 3) PCB DAISY CHAIN TRACING LINE WIDTH: 0.152 [6mil].
- 4) SMD (SOLDERMASK DEFINED) PAD OPENING: 0.508mm [20mil].

TopLine[®]

TITLE		SBGA2488T1.0C-DC507D DAISY CHAIN DUMMY	
SCALE	SIZE	DRAWING NO.	REV
1.75:1	A	515070	A
DO NOT SCALE DRAWING		SHEET 2 OF 12	

BALL VIEW

49 47 45 43 41 39 37 35 33 31 29 27 25 23 21 19 17 15 13 11 9 7 5 3 1
 50 48 46 44 42 40 38 36 34 32 30 28 26 24 22 20 18 16 14 12 10 8 6 4 2

A

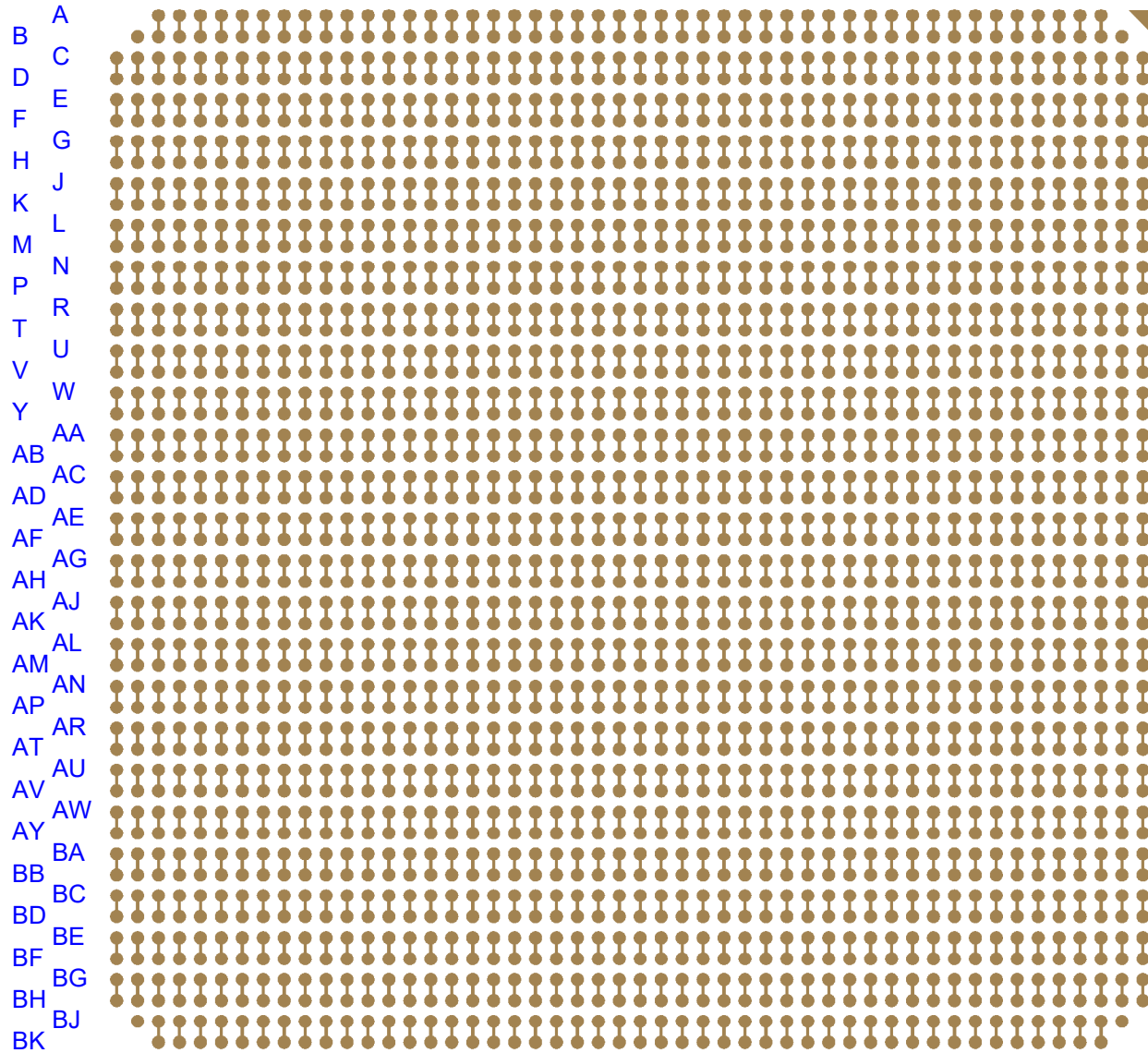

TopLine®			
TITLE SGA2488T1.0C-DC507D DAISY CHAIN DUMMY			
SCALE 3:1	SIZE A	DRAWING NO. 515070	REV A
DO NOT SCALE DRAWING		SHEET 3 OF 12	

BOTTOM SIDE (TOP X-RAY VIEW)

1 3 5 7 9 11 13 15 17 19 21 23 25 27 29 31 33 35 37 39 41 43 45 47 49
 2 4 6 8 10 12 14 16 18 20 22 24 26 28 30 32 34 36 38 40 42 44 46 48 50

A

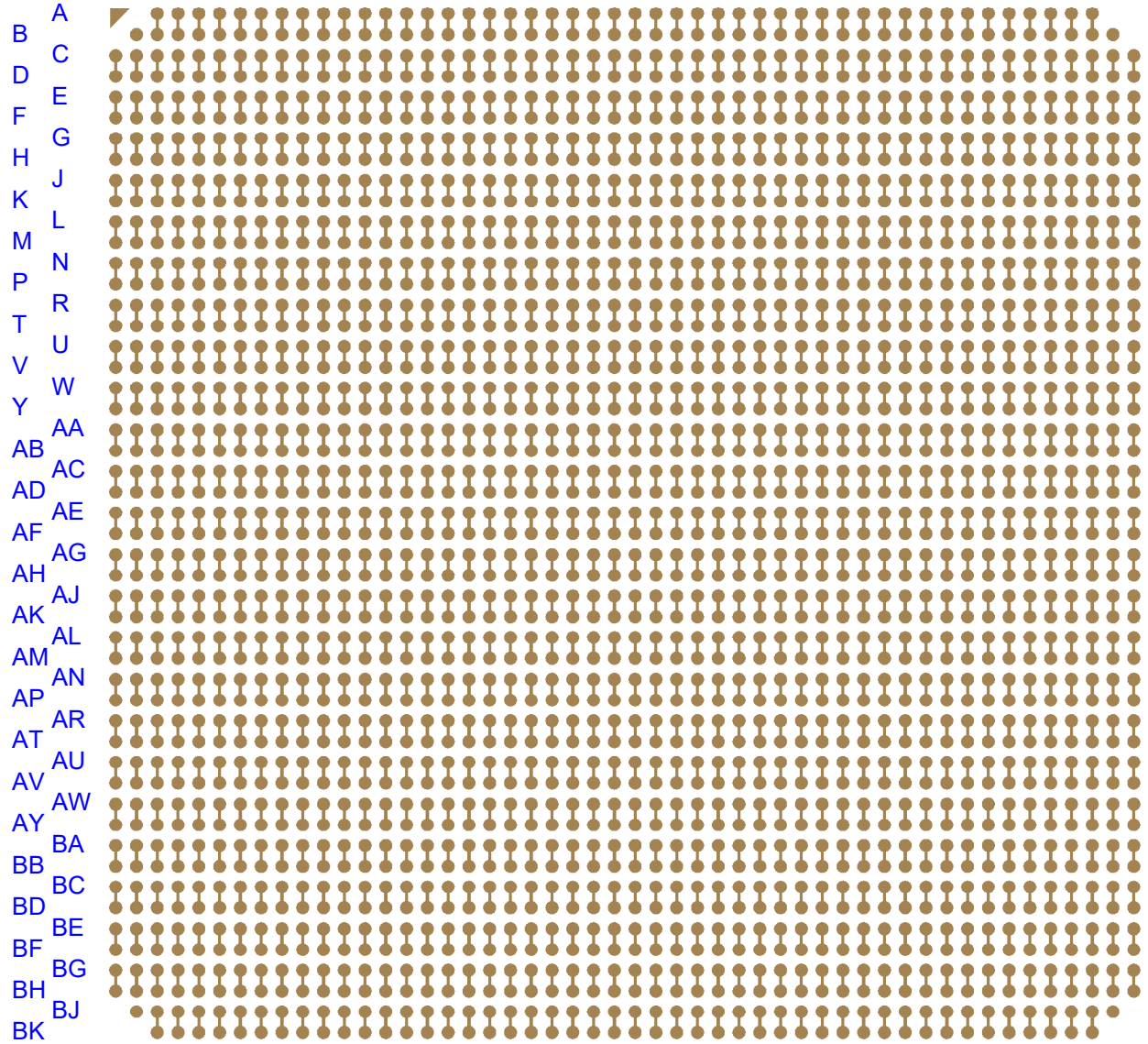

TopLine®			
TITLE SGA2488T1.0C-DC507D DAISY CHAIN DUMMY			
SCALE 3:1	SIZE A	DRAWING NO. 515070	REV A
DO NOT SCALE DRAWING		SHEET 4 OF 12	

TEST VEHICLE BOARD

1 3 5 7 9 11 13 15 17 19 21 23 25 27 29 31 33 35 37 39 41 43 45 47 49
 2 4 6 8 10 12 14 16 18 20 22 24 26 28 30 32 34 36 38 40 42 44 46 48 50

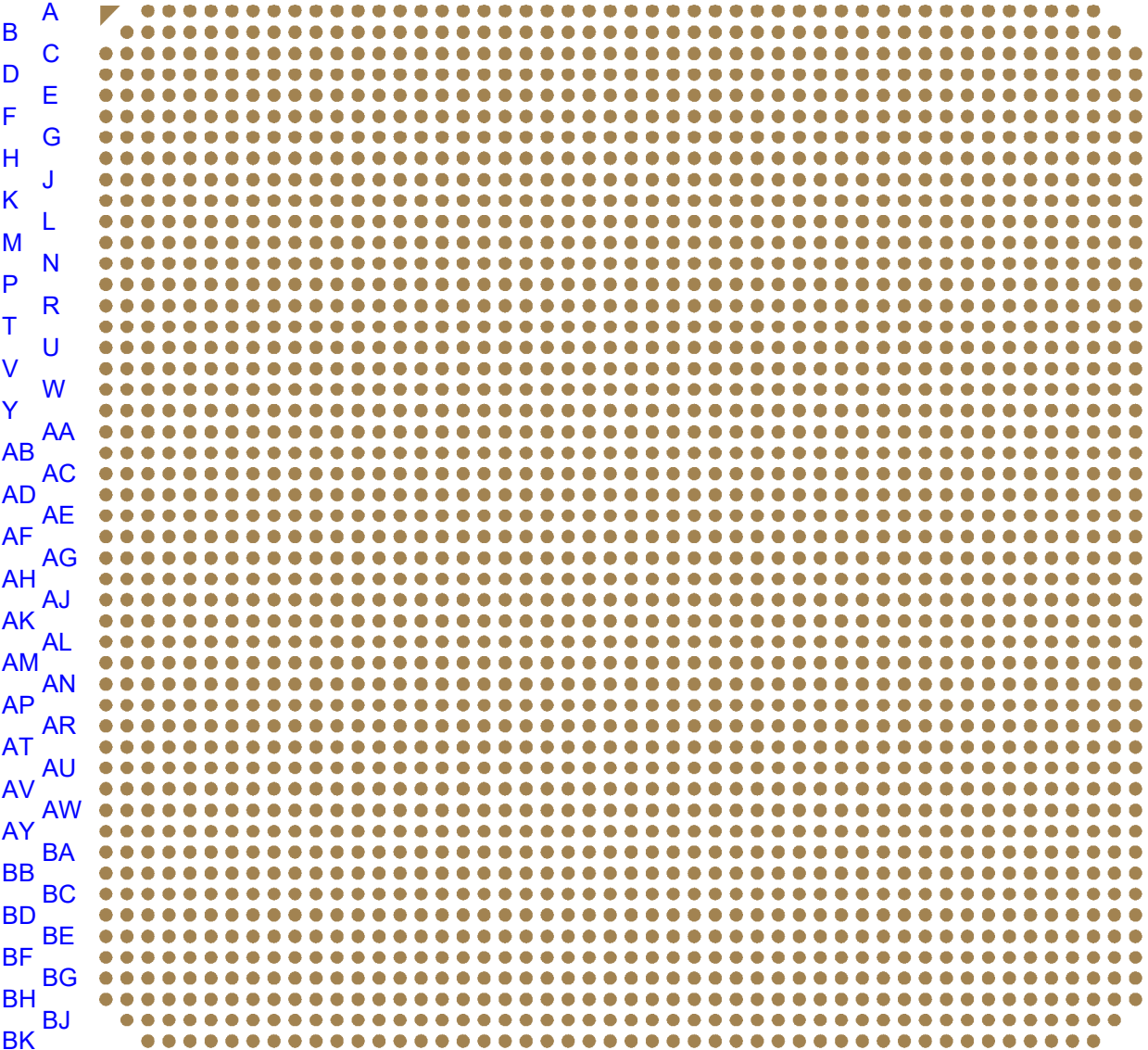

**UNDER
DEVELOPMENT**

TopLine®			
TITLE SGA2488T1.0C-DC507D DAISY CHAIN DUMMY			
SCALE 3:1	SIZE A	DRAWING NO. 515070	REV A
DO NOT SCALE DRAWING		SHEET 5 OF 12	

AFTER MOUNTING TO TEST BOARD

1 3 5 7 9 11 13 15 17 19 21 23 25 27 29 31 33 35 37 39 41 43 45 47 49
 2 4 6 8 10 12 14 16 18 20 22 24 26 28 30 32 34 36 38 40 42 44 46 48 50

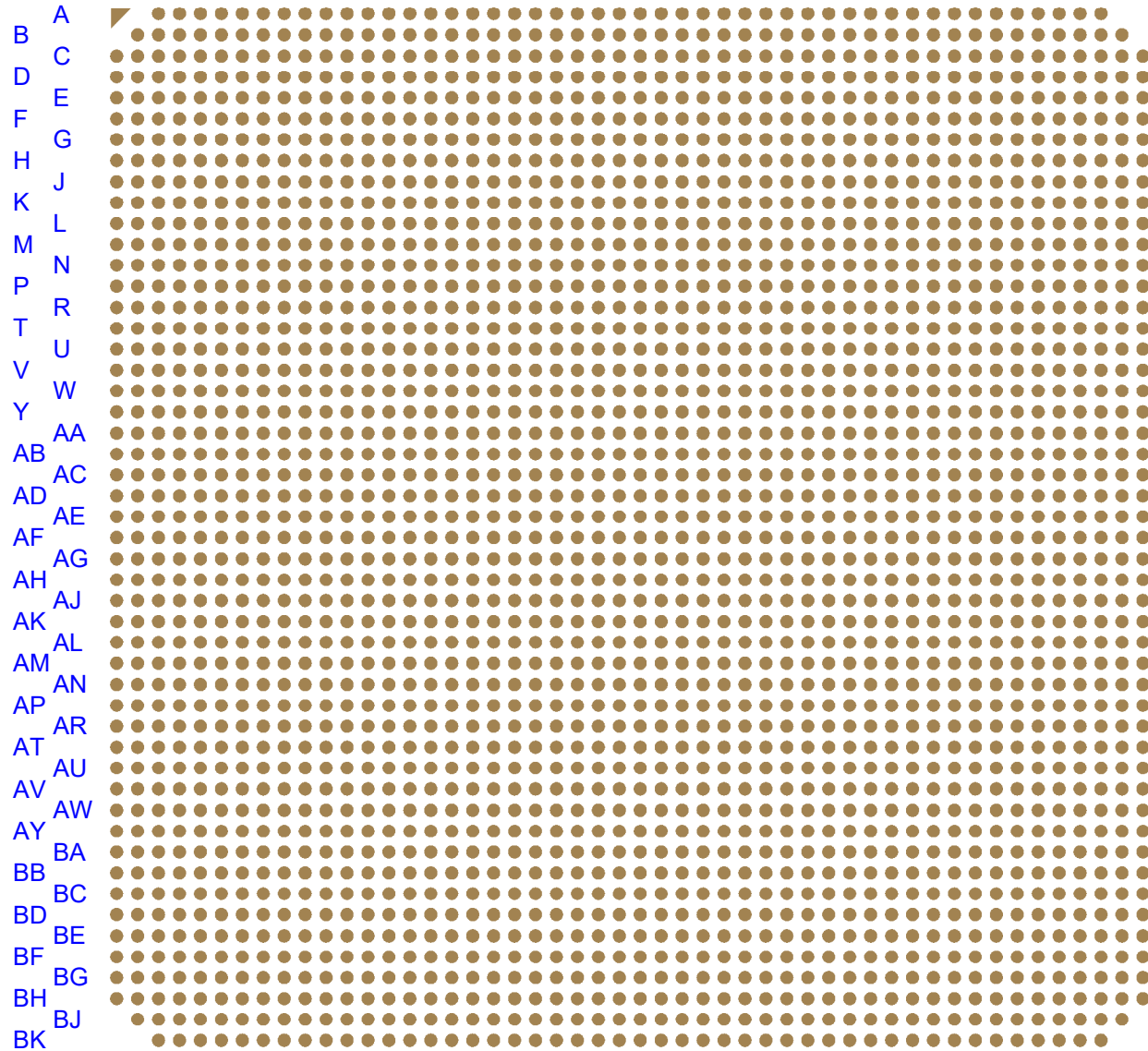

**UNDER
DEVELOPMENT**

TopLine®

TITLE SPGA2488T1.0C-DC507D
DAISY CHAIN DUMMY

SCALE 3:1	SIZE A	DRAWING NO. 515070	REV A
--------------	-----------	-----------------------	----------

DO NOT SCALE DRAWING

SHEET 6 OF 12

HEAT SPREADER

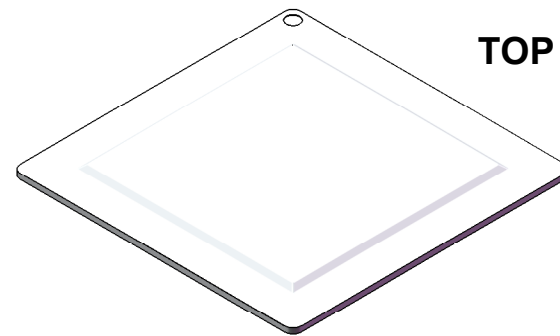
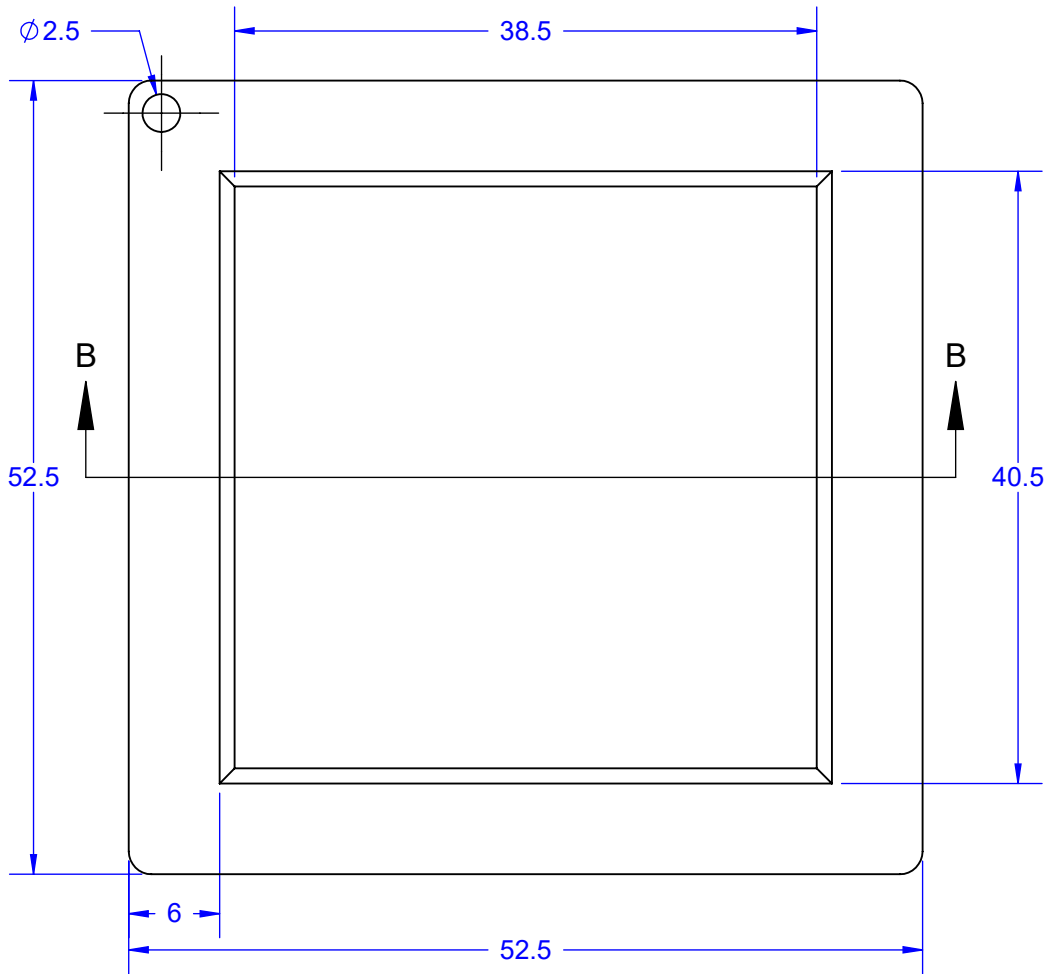

TOP

MODEL

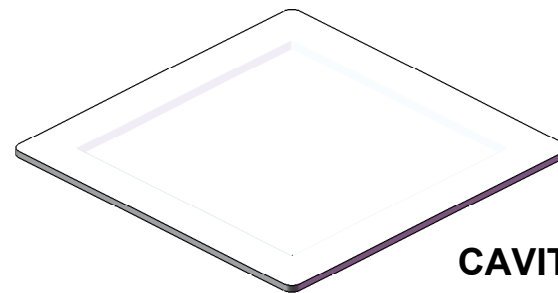

CAVITY

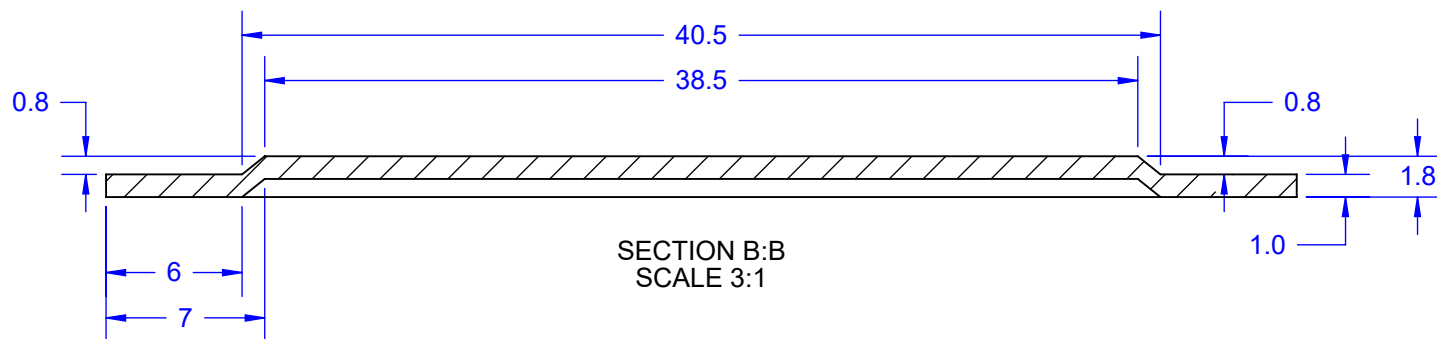

TopLine[®]

TITLE SBGA2488T1.0C-DC507D
DAISY CHAIN DUMMY

SCALE 3:1	SIZE A	DRAWING NO. 515070	REV A
--------------	-----------	-----------------------	----------

DO NOT SCALE DRAWING

SHEET 7 OF 12

MODEL

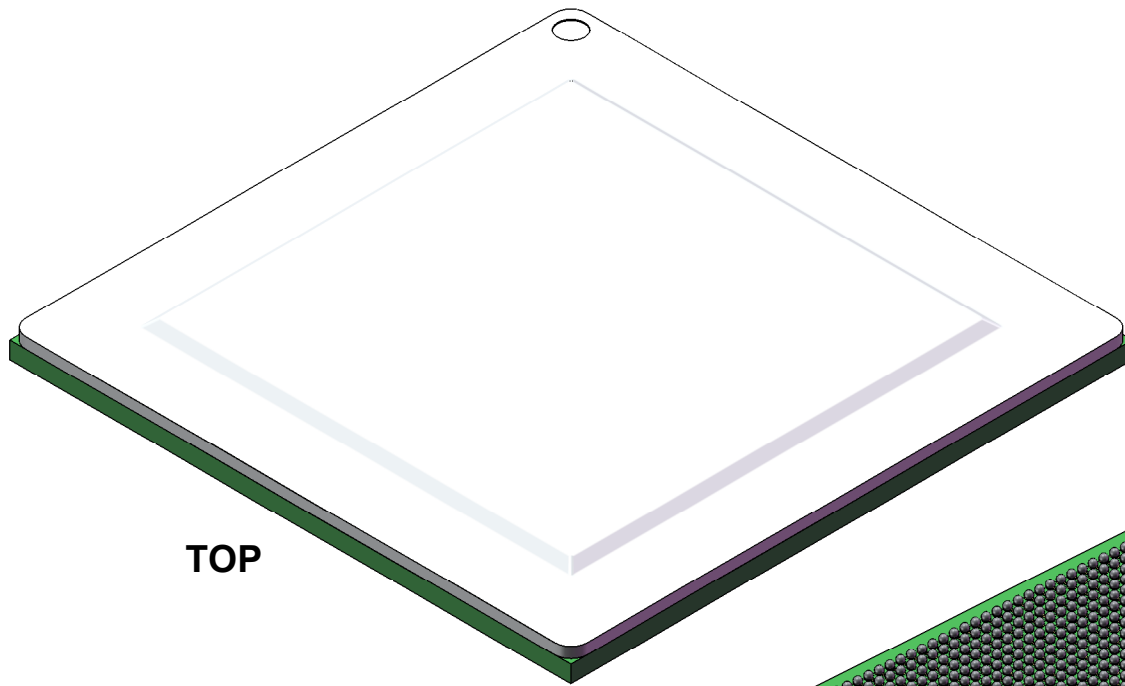

TOP

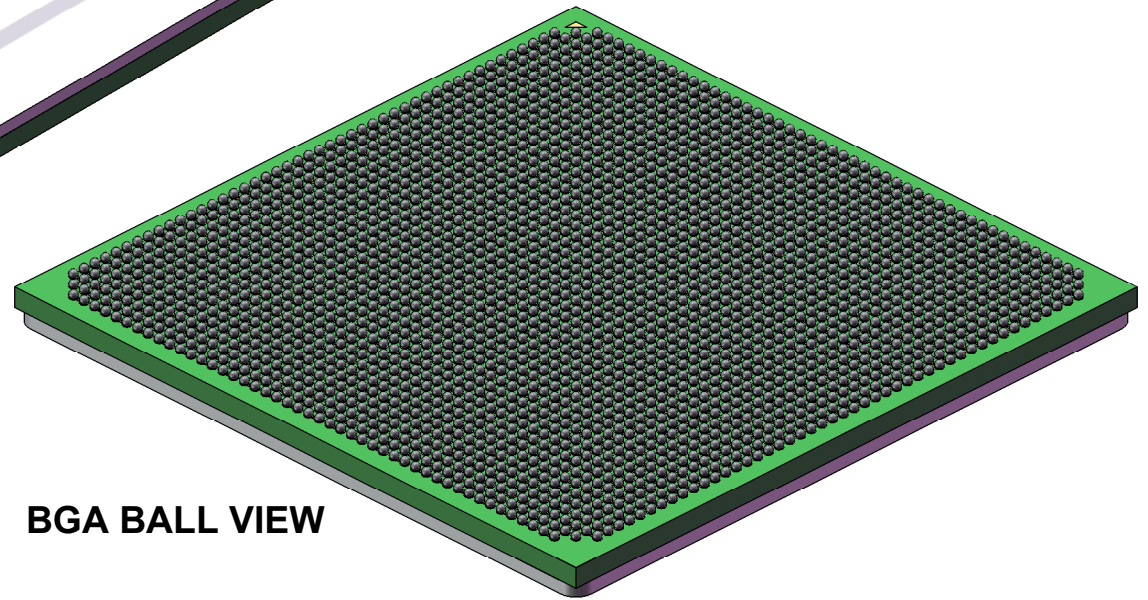

BGA BALL VIEW

TopLine[®]

TITLE SBGA2488T1.0C-DC507D
DAISY CHAIN DUMMY

SCALE 2:1	SIZE A	DRAWING NO. 515070	REV A
--------------	-----------	-----------------------	----------

DO NOT SCALE DRAWING

SHEET 8 OF 12

TOP LAYER - LAYER 1

1 3 5 7 9 11 13 15 17 19 21 23 25 27 29 31 33 35 37 39 41 43 45 47 49
 2 4 6 8 10 12 14 16 18 20 22 24 26 28 30 32 34 36 38 40 42 44 46 48 50

A
B
C
D
E
F
G
H
J
K
L
M
N
P
R
T
U
V
W
Y
AA
AB
AC
AD
AE
AF
AG
AH
AJ
AK
AL
AM
AN
AP
AR
AT
AU
AV
AW
AY
BA
BB
BC
BD
BE
BF
BG
BH
BJ
BK

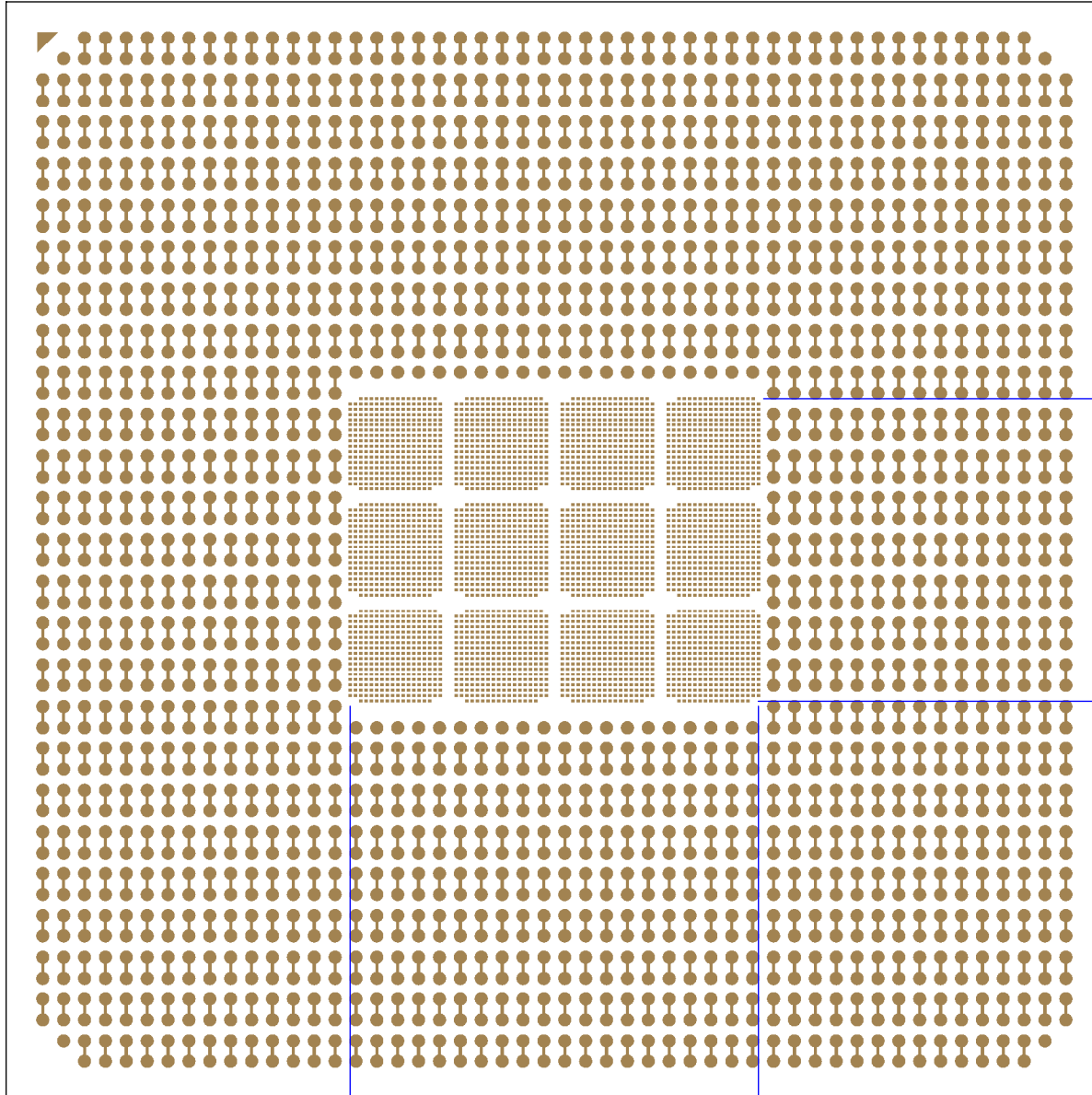

15.42

19.56

52.50

TopLine®			
TITLE SGBA2488T1.0C-DC507D DAISY CHAIN DUMMY			
SCALE 3:1	SIZE A	DRAWING NO. 515070	REV A
DO NOT SCALE DRAWING		SHEET 9 OF 12	

1 3 5 7 9 11 13 15 17 19 21 23 25 27 29 31 33 35 37 39 41 43 45 47 49
 2 4 6 8 10 12 14 16 18 20 22 24 26 28 30 32 34 36 38 40 42 44 46 48 50

SOLDER MASK TOP

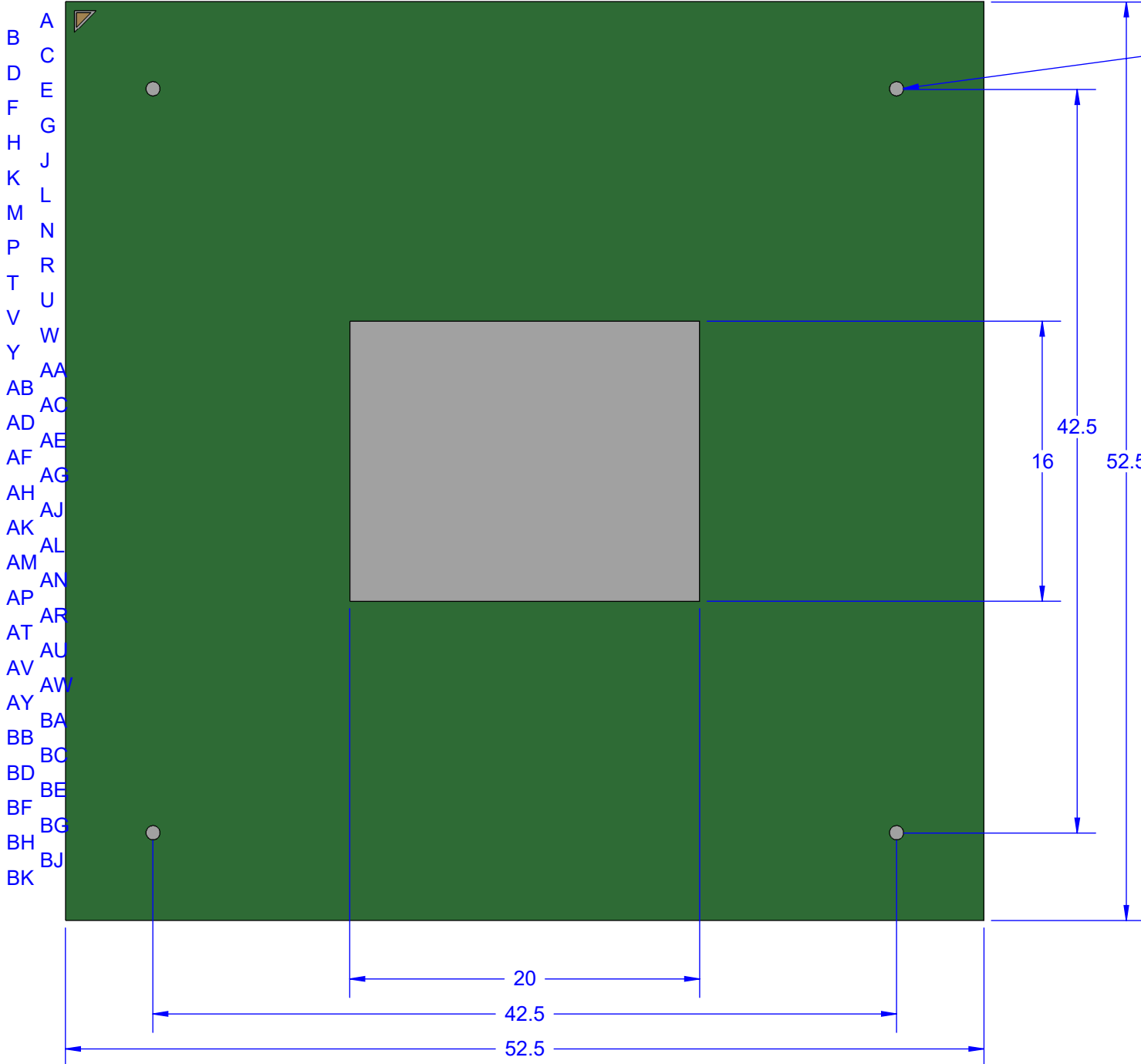

MASK OPEN FIDUCIAL
 4 PLACES $\varnothing 0.8$

TopLine®			
TITLE SBGA2488T1.0C-DC507D DAISY CHAIN DUMMY			
SCALE 3:1	SIZE A	DRAWING NO. 515070	REV A
DO NOT SCALE DRAWING			SHEET 10 OF 12

BOTTOM SIDE (TOP X-RAY VIEW) - LAYER 4

1 3 5 7 9 11 13 15 17 19 21 23 25 27 29 31 33 35 37 39 41 43 45 47 49
 2 4 6 8 10 12 14 16 18 20 22 24 26 28 30 32 34 36 38 40 42 44 46 48 50

A
B
C
D
E
F
G
H
J
K
L
M
N
P
R
T
U
V
W
Y
AA
AB
AC
AD
AE
AF
AG
AH
AJ
AK
AL
AM
AN
AP
AR
AT
AU
AV
AW
AY
BA
BB
BC
BD
BE
BF
BG
BH
BJ
BK

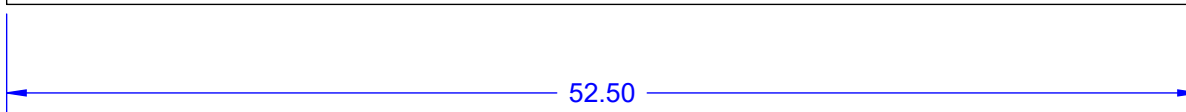
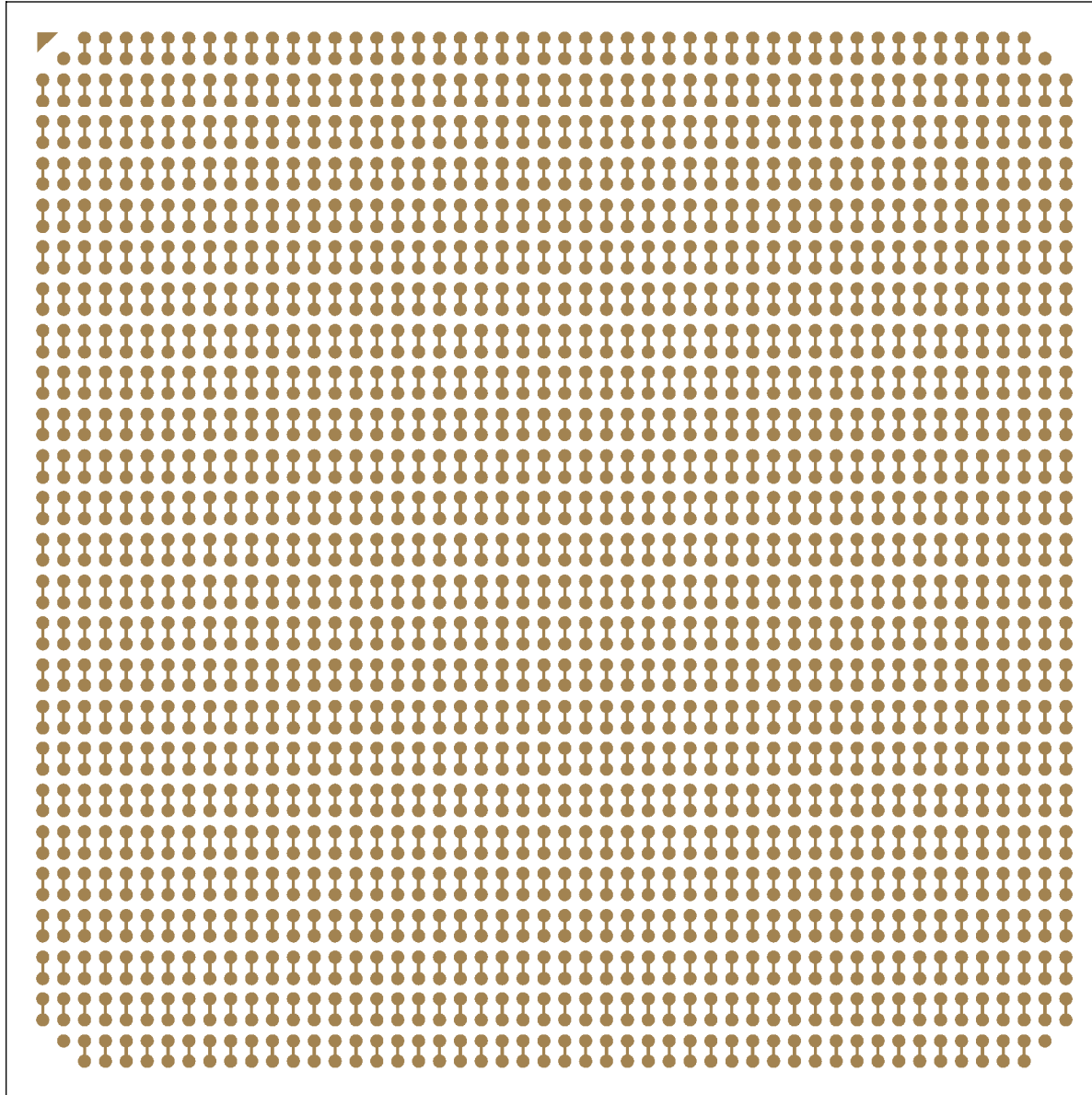

TopLine®			
TITLE SPGA2488T1.0C-DC507D DAISY CHAIN DUMMY			
SCALE 3:1	SIZE A	DRAWING NO. 515070	REV A
DO NOT SCALE DRAWING		SHEET 11 OF 12	

DETAIL B
PCB DIE PADS (TOP)
 Micron (μm)

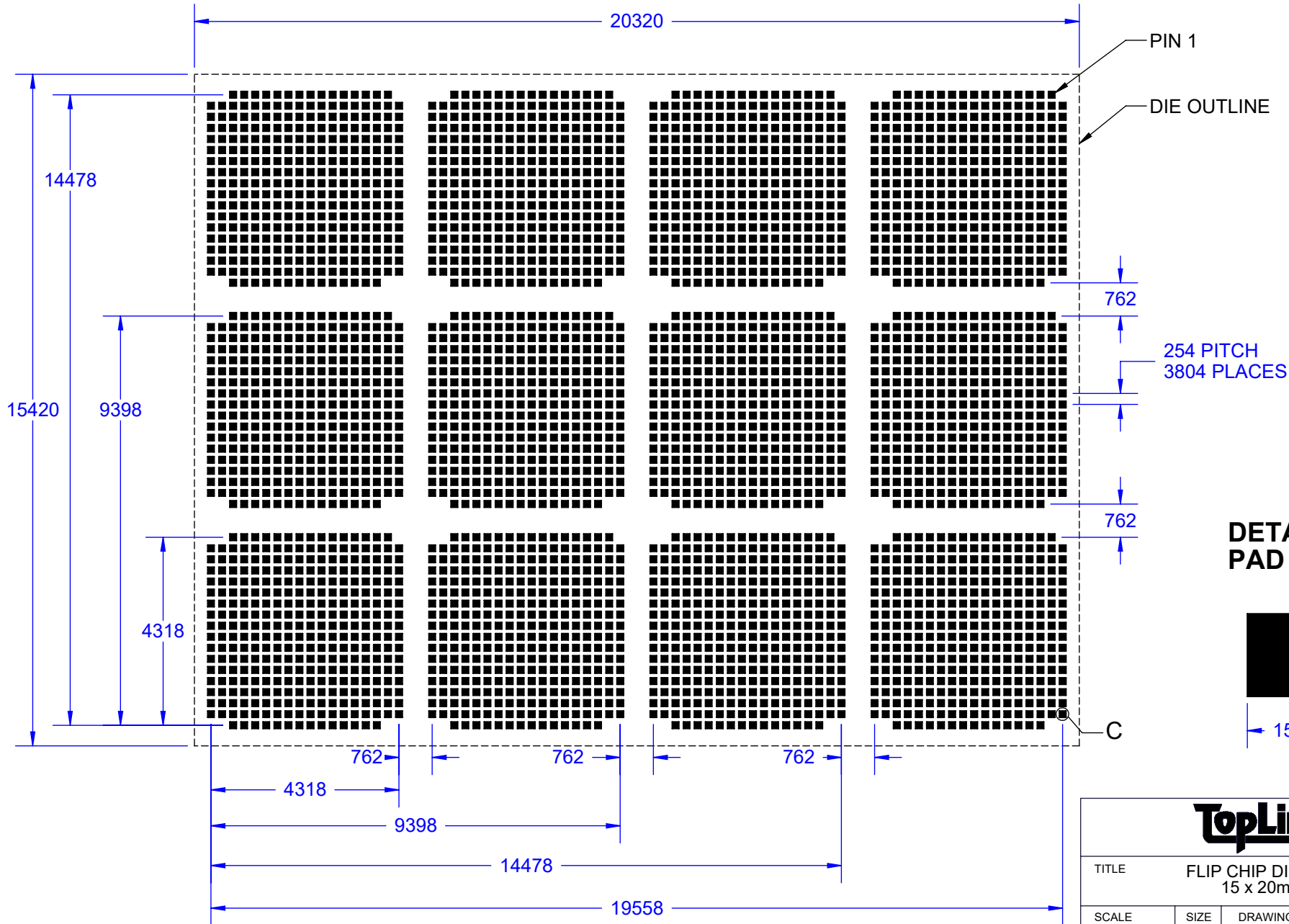

DETAIL C
PAD SIZE

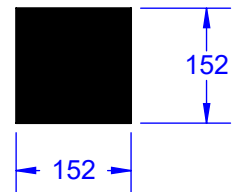

TopLine®			
TITLE FLIP CHIP DIE PAD 15 x 20mm			
SCALE 8:1	SIZE A	DRAWING NO. 515070	REV A
DO NOT SCALE DRAWING		SHEET 12 OF 12	