

TOP VIEW

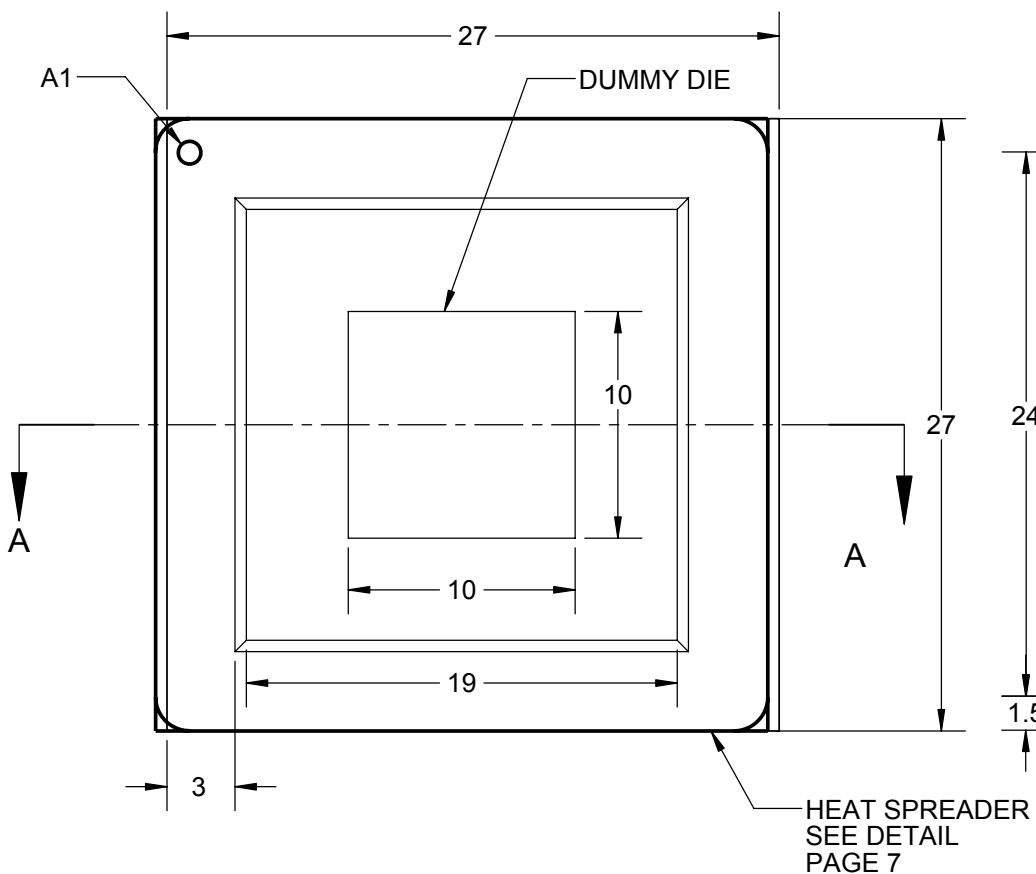

BALL VIEW

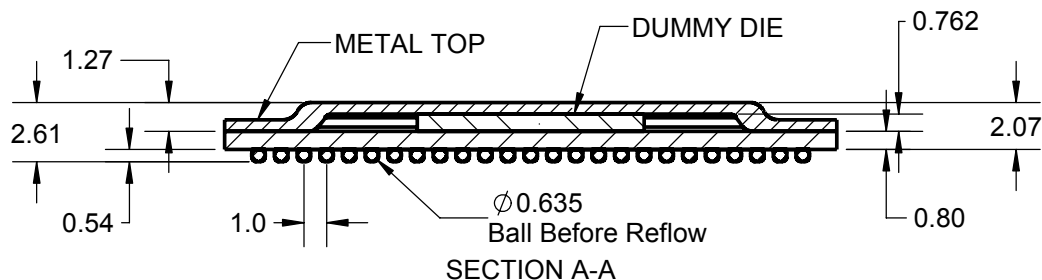
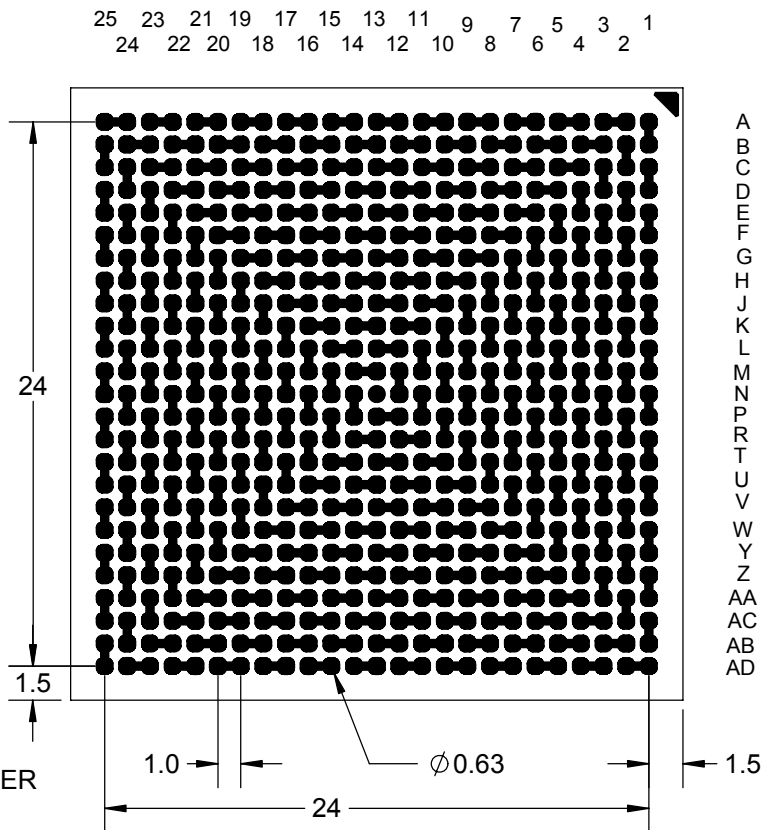

Notes: (Unless Otherwise Specified).

- 1) ALL DIMENSIONS ARE IN MM.
- 2) SOLDER BALL ALLOY: SEE PART NUMBER TABLE.
- 3) BALL DIAMETER (BEFORE REFLOW) 0.635mm [25 mil].
- 4) SOLDER MASK DEFINED PAD OPENING: 0.508mm [20mil].
- 5) PAD Cu DIAMETER: 0.635mm [25 mil].
- 6) SUBSTRATE MATERIAL: FR4 (OPTIONAL BT).
- 7) DUMMY DIE: Si (SILICON).
- 8) DAISY CHAIN PATTERN (SEE PAGE 2).
- 9) MSL-3 RECOMMENDED BAKING 24 HOURS @ 125°C TO REMOVE MOISTURE PRIOR TO SOLDERING TO PC BOARD.

PART NUMBER TABLE

PART NUMBER	BALL METAL	BALL ALLOY	RoHS	Si DIE
SBGA625T1.0C-DC259D	Sn96.5/Ag3.0/Cu0.5	SAC305	YES	YES
SBGA625T1.0-DC259D	Sn63/Pb37	Sn63	NO	YES

APPROVALS	DATE	TopLine®			
DRAWN T. Au	10/3/2016				
ENG M. Hart	10/3/2016	TITLE SBGA625T1.0C-DC259D DAISY CHAIN DUMMY			
MFG		SCALE 2.5:1	SIZE A	DRAWING NO. 512595	REV A
QA		DO NOT SCALE DRAWING			SHEET 1 OF 16
CUST					
REVISED					

BALL VIEW

33 31 29 27 25 23 21 19 17 15 13 11 9 7 5 3 1
34 32 30 28 26 24 22 20 18 16 14 12 10 8 6 4 2

A
B
C
D
E
F
G
H
J
K
L
M
N
P
R
T
U
V
W
Y
Z
AA
AB
AC
AD

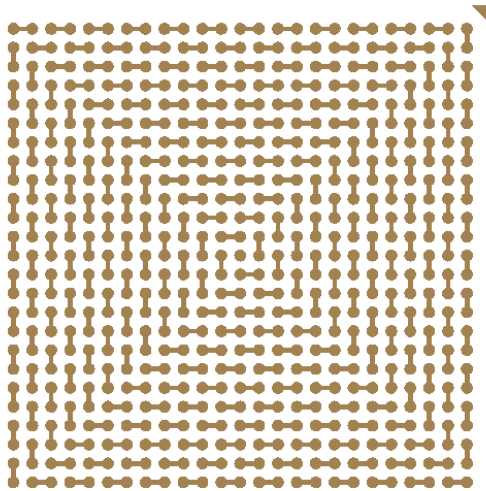

BOTTOM SIDE (TOP X-RAY VIEW)

2 4 6 8 10 12 14 16 18 20 22 24
1 3 5 7 9 11 13 15 17 19 21 23 25

A
B
C
D
E
F
G
H
J
K
L
M
N
P
R
T
U
V
W
Y
Z
AA
AB
AC
AD

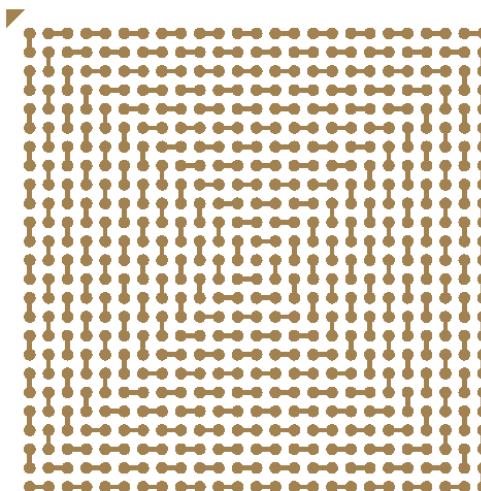

2 4 6 8 10 12 14 16 18 20 22 24
1 3 5 7 9 11 13 15 17 19 21 23 25

A
B
C
D
E
F
G
H
J
K
L
M
N
P
R
T
U
V
W
Y
Z
AA
AB
AC
AD

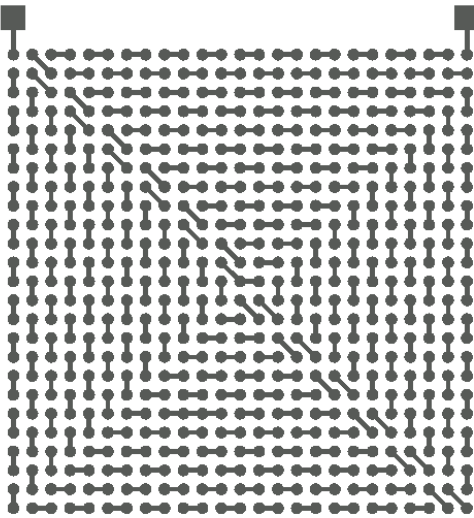

TEST VEHICLE BOARD

2 4 6 8 10 12 14 16 18 20 22 24
1 3 5 7 9 11 13 15 17 19 21 23 25

A
B
C
D
E
F
G
H
J
K
L
M
N
P
R
T
U
V
W
Y
Z
AA
AB
AC
AD

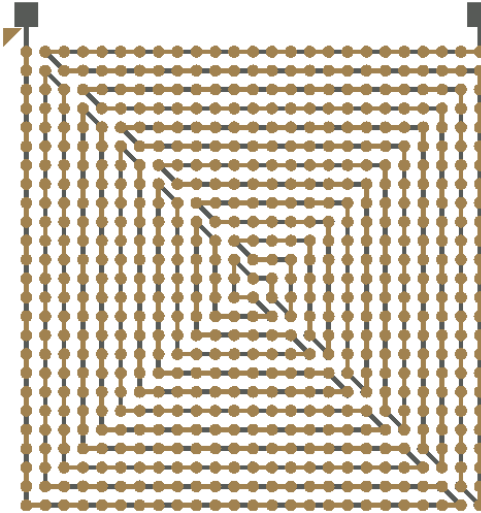

AFTER MOUNTING

Notes: (Unless Otherwise Specified).

- 1) PCB BOARD DIMENSIONS ARE PRESENTED ONLY AS A GUIDELINE DESIGNERS SHOULD USE THEIR OWN KNOWLEDGE WHEN DESIGNING THE PCB.
- 2) PCB Cu BALL PAD DIAMETER: 0.450 [25 mil].
- 3) PCB DAISY CHAIN TRACING LINE WIDTH: 0.152 [6mil].
- 4) SMD (SOLDERMASK DEFINED) PAD OPENING: 0.508mm [20mil].

TopLine®

TITLE			
SBGA625T1.0C-DC259D DAISY CHAIN DUMMY			
SCALE	SIZE	DRAWING NO.	REV
2:1	A	512595	A
DO NOT SCALE DRAWING			SHEET 2 OF 16

BALL VIEW

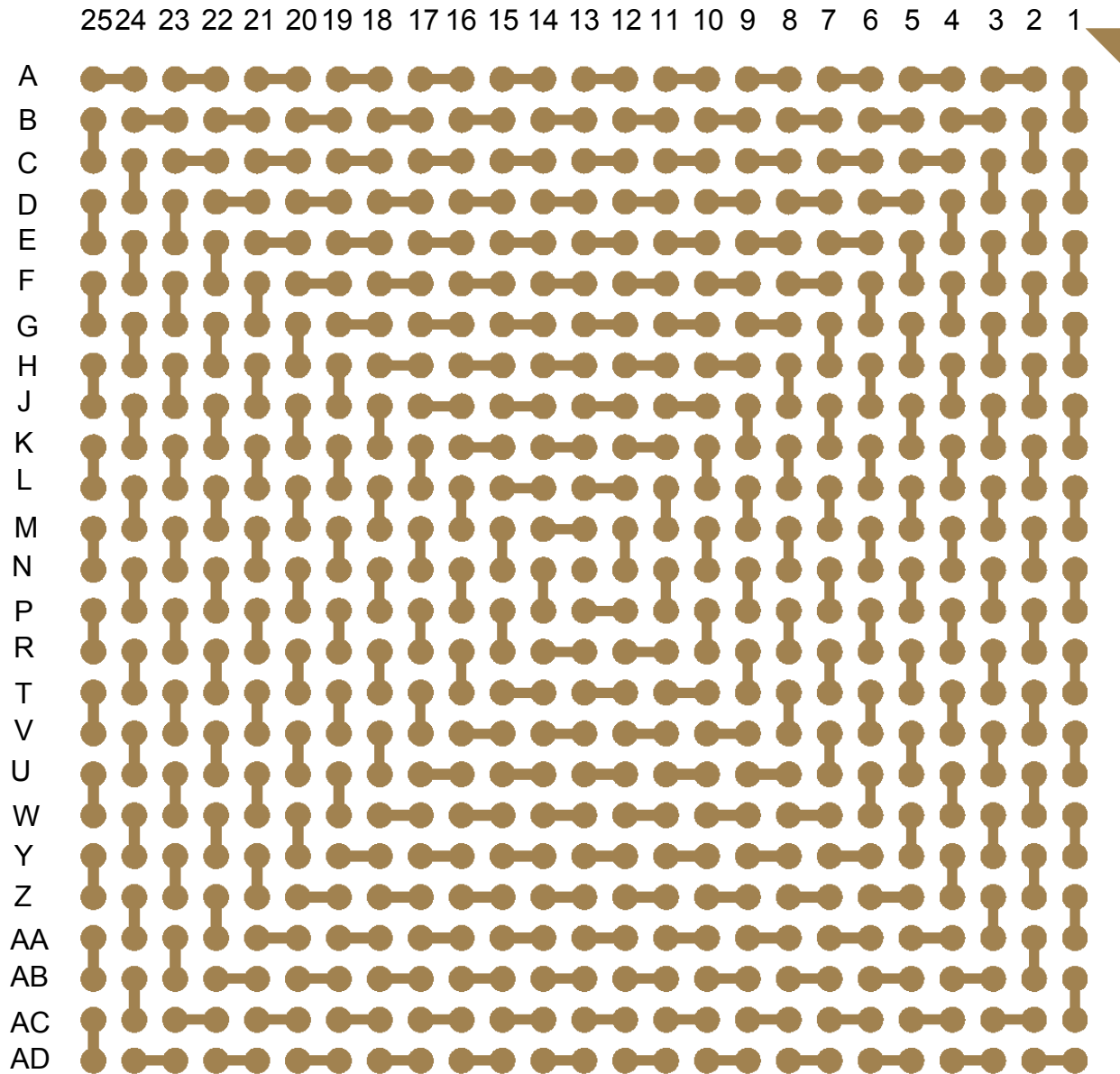

TopLine®			
TITLE SBGA625T1.0C-DC259D DAISY CHAIN DUMMY			
SCALE 4.5:1	SIZE A	DRAWING NO. 512595	REV A
DO NOT SCALE DRAWING		SHEET 3 OF 16	

BOTTOM SIDE (TOP X-RAY VIEW)

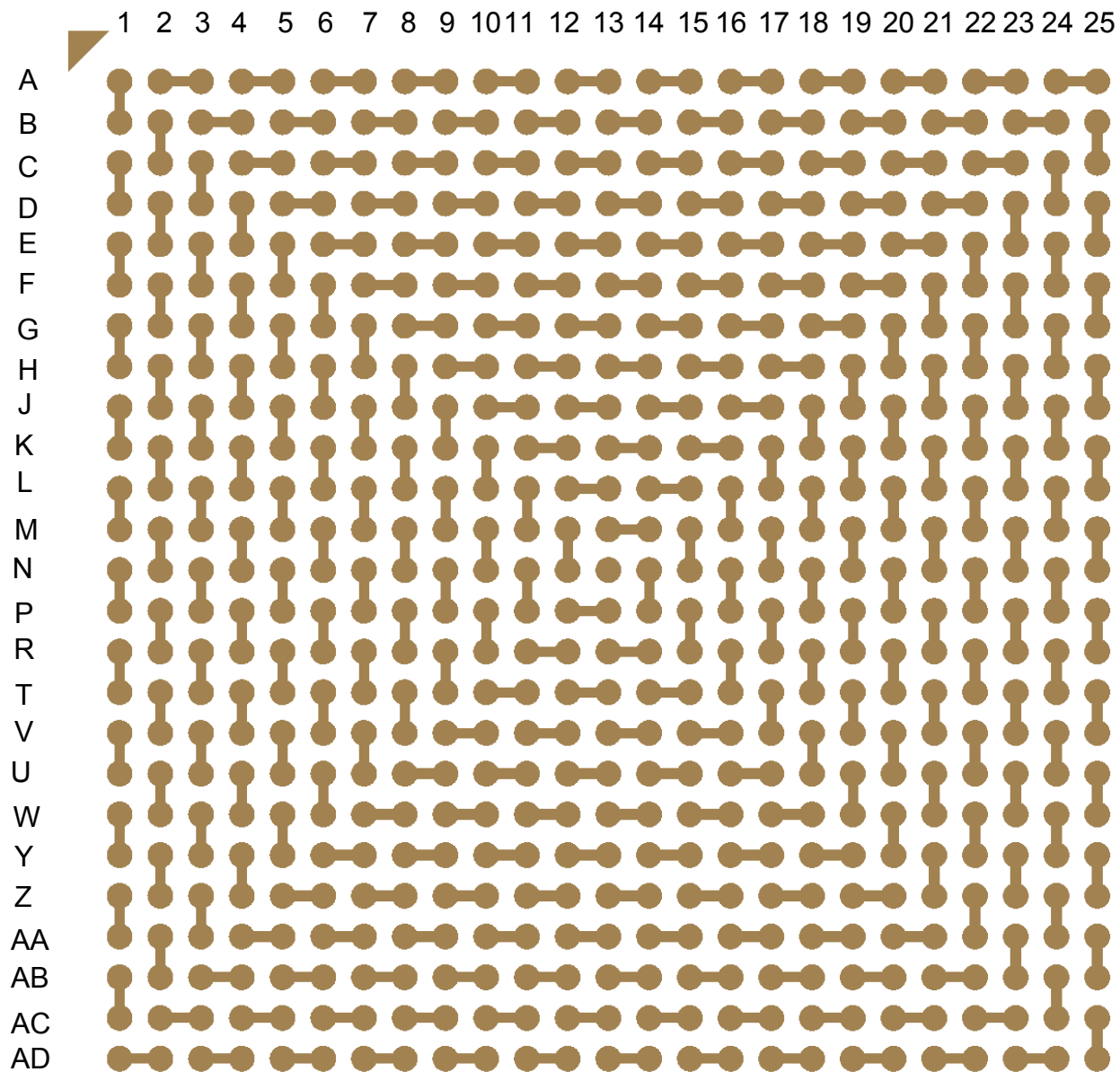

TopLine[®]

TITLE SBGA625T1.0C-DC259D
DAISY CHAIN DUMMY

SCALE 4.5:1	SIZE A	DRAWING NO. 512595	REV A
----------------	-----------	-----------------------	----------

TEST VEHICLE BOARD

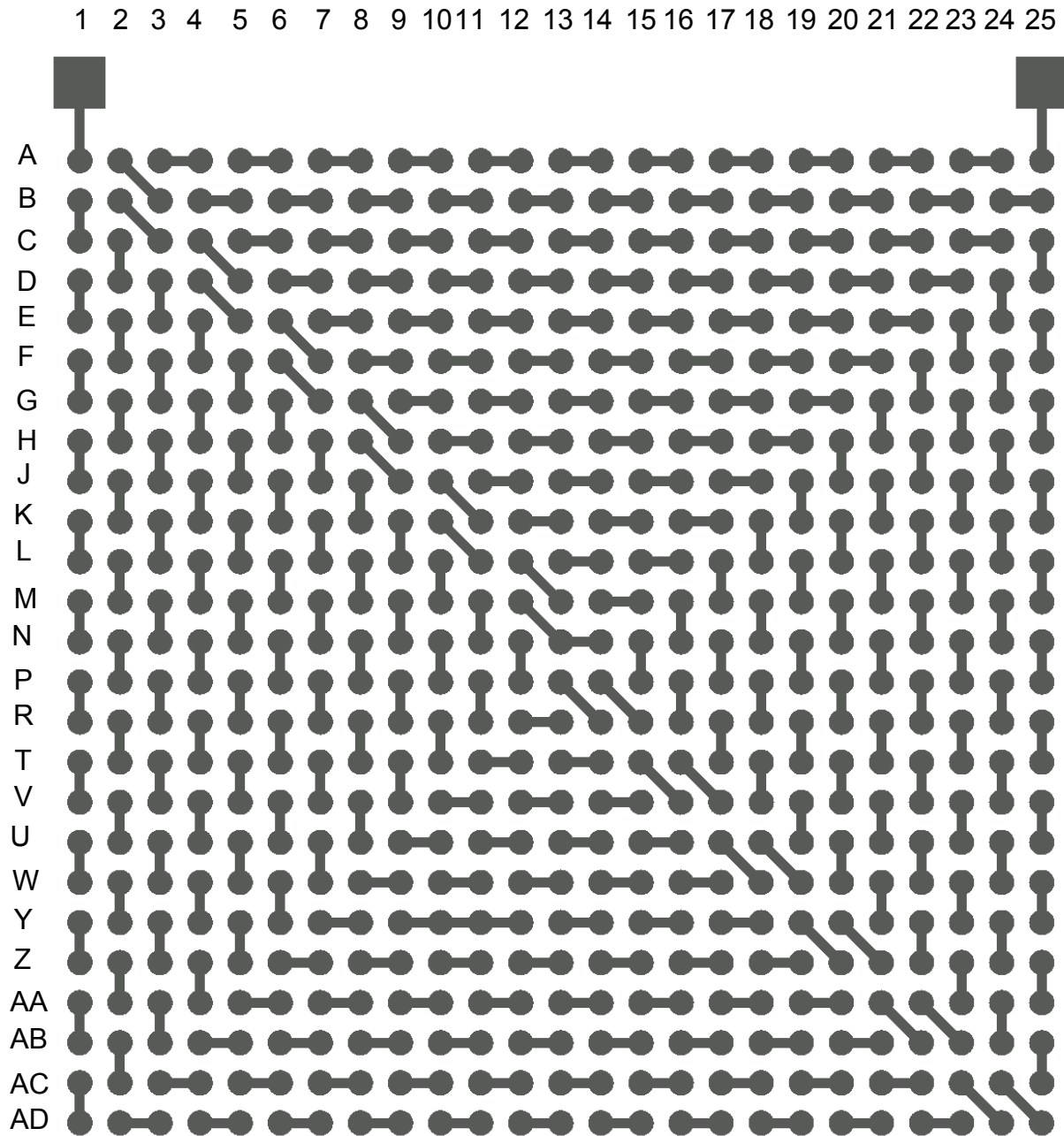

TopLine®			
TITLE SBGA625T1.0C-DC259D DAISY CHAIN DUMMY			
SCALE 4.5:1	SIZE A	DRAWING NO. 512595	REV A
DO NOT SCALE DRAWING		SHEET 5 OF 16	

AFTER MOUNT TO TEST BOARD

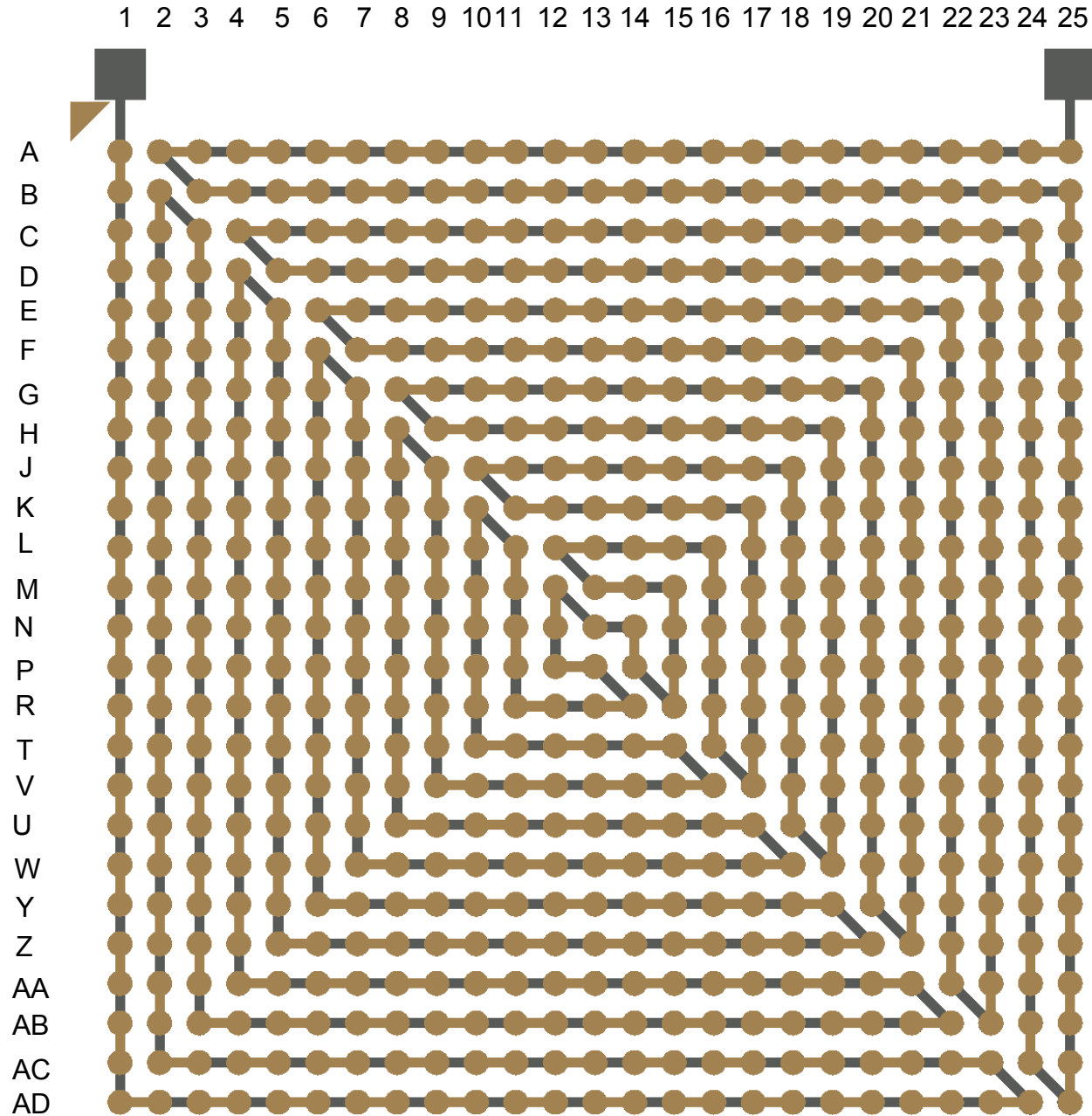

TopLine[®]			
TITLE SBGA625T1.0C-DC259D DAISY CHAIN DUMMY			
SCALE 4.5:1	SIZE A	DRAWING NO. 512595	REV A
DO NOT SCALE DRAWING		SHEET 6 OF 16	

HEAT SPREADER

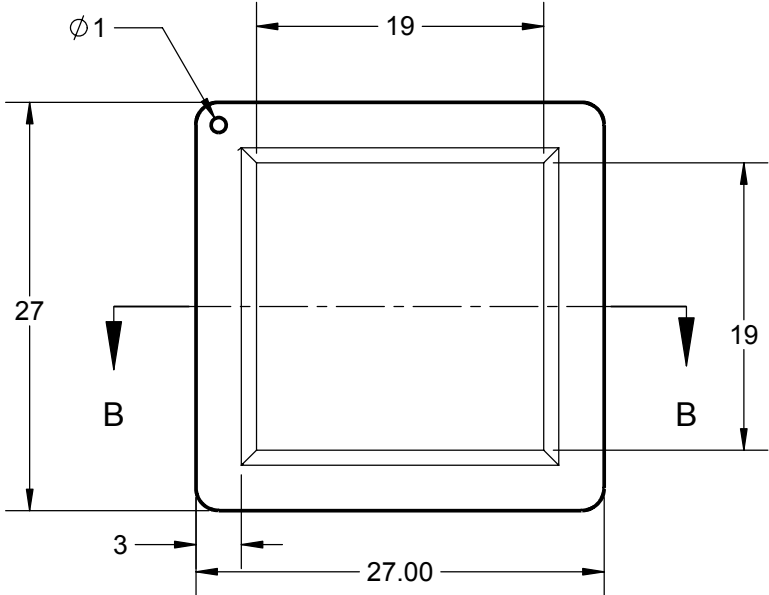

TOP

MODEL



CAVITY

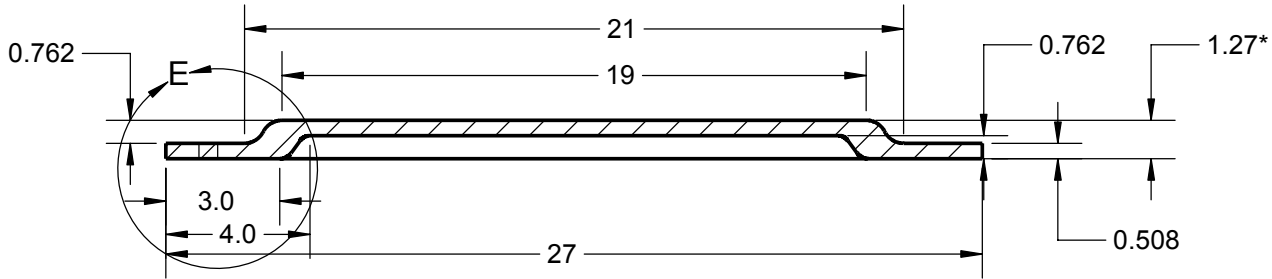
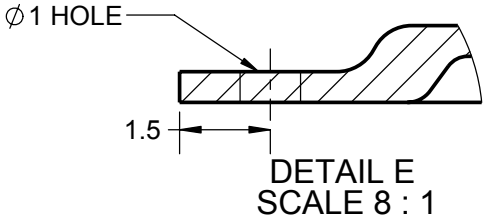

SECTION B-B
SCALE 4 : 1

* ADD 0.13MM SEALANT

TopLine®			
TITLE SBGA625T1.0C-DC259D DAISY CHAIN DUMMY			
SCALE 2:1	SIZE A	DRAWING NO. 512595	REV A
DO NOT SCALE DRAWING			SHEET 7 OF 16

MODEL

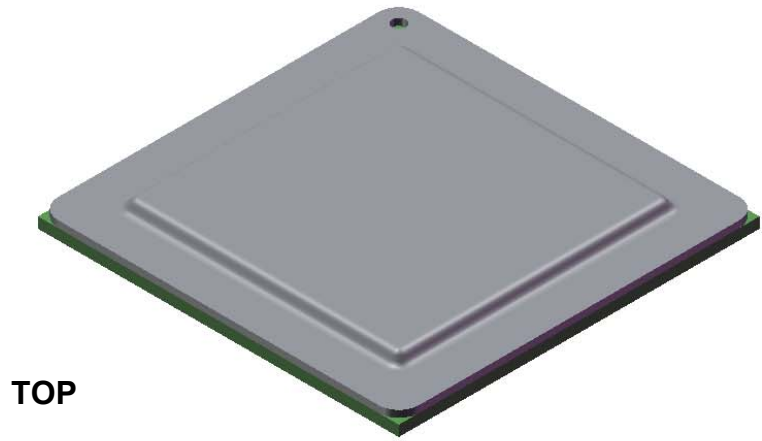

TOP

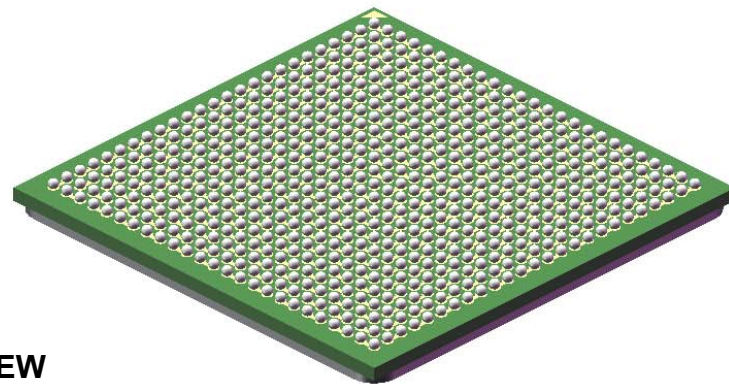

PAD VIEW

TopLine[®]

TITLE SBGA625T1.0C-DC259D
DAISY CHAIN DUMMY

SCALE 2.5:1	SIZE A	DRAWING NO. 512595	REV A
----------------	-----------	-----------------------	----------

DAISY CHAIN NET LIST

DC PAIR	
A1	B1
C1	D1
E1	F1
G1	H1
J1	K1
L1	M1
N1	P1
R1	T1
U1	V1
W1	Y1
Z1	AA1
AB1	AC1
AD1	AD2
AD3	AD4
AD5	AD6
AD7	AD8
AD9	AD10
AD11	AD12
AD13	AD14
AD15	AD16
AD17	AD18
AD19	AD20
AD21	AD22
AD23	AD24
AD25	AC25
AB25	AA25
Z25	Y25
W25	V25
U25	T25
R25	P25
N25	M25
L25	K25
J25	H25
G25	F25
E25	D25
C25	B25
A25	A24
A23	A22
A21	A20
A19	A18
A17	A16
A15	A14
A13	A12
A11	A10

DC PAIR	
A9	A8
A7	A6
A5	A4
A3	A2
B2	C2
D2	E2
F2	G2
H2	J2
K2	L2
M2	N2
P2	R2
T2	U2
V2	W2
Y2	Z2
AA2	AB2
AC2	AC3
AC4	AC5
AC6	AC7
AC8	AC9
AC10	AC11
AC12	AC13
AC14	AC15
AC16	AC17
AC18	AC19
AC20	AC21
AC22	AC23
AC24	AB24
AA24	Z24
Y24	W24
V24	U24
T24	R24
P24	N24
M24	L24
K24	J24
H24	G24
F24	E24
D24	C24
B24	B23
B22	B21
B20	B19
B18	B17
B16	B15
B14	B13
B12	B11

DC PAIR	
B10	B9
B8	B7
B6	B5
B4	B3
C3	D3
E3	F3
G3	H3
J3	K3
L3	M3
N3	P3
R3	T3
U3	V3
W3	Y3
Z3	AA3
AB3	AB4
AB5	AB6
AB7	AB8
AB9	AB10
AB11	AB12
AB13	AB14
AB15	AB16
AB17	AB18
AB19	AB20
AB21	AB22
AB23	AA23
Z23	Y23
W23	V23
U23	T23
R23	P23
N23	M23
L23	K23
J23	H23
G23	F23
E23	D23
C23	C22
C21	C20
C19	C18
C17	C16
C15	C14
C13	C12
C11	C10
C9	C8
C7	C6
C5	C4

DC PAIR	
D4	E4
F4	G4
H4	J4
K4	L4
M4	N4
P4	R4
T4	U4
V4	W4
Y4	Z4
AA4	AA5
AA6	AA7
AA8	AA9
AA10	AA11
AA12	AA13
AA14	AA15
AA16	AA17
AA18	AA19
AA20	AA21
AA22	Z22
Y22	W22
V22	U22
T22	R22
P22	N22
M22	L22
K22	J22
H22	G22
F22	E22
D22	D21
D20	D19
D18	D17
D16	D15
D14	D13
D12	D11
D10	D9
D8	D7
D6	D5
E5	F5
G5	H5
J5	K5
L5	M5
N5	P5
R5	T5
U5	V5
W5	Y5

DC PAIR	
Z5	Z6
Z7	Z8
Z9	Z10
Z11	Z12
Z13	Z14
Z15	Z16
Z17	Z18
Z19	Z20
Z21	Y21
W21	V21
U21	T21
R21	P21
N21	M21
L21	K21
J21	H21
G21	F21
E21	E20
E19	E18
E17	E16
E15	E14
E13	E12
E11	E10
E9	E8
E7	E6
F6	G6
H6	J6
K6	L6
M6	N6
P6	R6
T6	U6
V6	W6
Y6	Y7
Y8	Y9
Y10	Y11
Y12	Y13
Y14	Y15
Y16	Y17
Y18	Y19
Y20	W20
V20	U20
T20	R20
P20	N20
M20	L20
K20	J20

DC PAIR	
H20	G20
F20	F19
F18	F17
F16	F15
F14	F13
F12	F11
F10	F9
F8	F7
G7	H7
J7	K7
L7	M7
N7	P7
R7	T7
U7	V7
W7	W8
W9	W10
W11	W12
W13	W14
W15	W16
W17	W18
W19	V19
U19	T19
R19	P19
N19	M19
L19	K19
G19	G18
G17	G16
G15	G14
G13	G12
G11	G10
G9	G8
H8	J8
K8	L8
M8	N8
P8	R8
T8	U8
V8	V9
V10	V11
V12	V13
V14	V15
V16	V17
V18	U18
T18	R18

DC PAIR	
P18	N18
M18	L18
K18	J18
H18	H17
H16	H15
H14	H13
H12	H11
H10	H9
J9	K9
L9	M9
N9	P9
R9	T9
U9	U10
U11	U12
U13	U14
U15	U16
U17	T17
R17	P17
N17	M17
L17	K17
J17	J16
J15	J14
J13	J12
J11	J10
K10	L10
M10	N10
P10	R10
T10	T11
T12	T13
T14	T15
T16	R16
P16	N16
M16	L16
K16	K15
K14	K13

DC PAIR	
K12	K11
L11	M11
N11	P11
R11	R12
R13	R14
R15	P15
N15	M15
L15	L14
L13	L12
M12	N12
P12	P13
P14	N14
M14	M13
N13	-

TopLine [®]			
TITLE SBGA625T1.0C-DC259D DAISY CHAIN DUMMY			
SCALE 2.5:1	SIZE A	DRAWING NO. 512595	REV A
DO NOT SCALE DRAWING			SHEET 9 OF 16

TOP LAYER - LAYER 1

1 2 3 4 5 6 7 8 9 10 11 12 13 14 15 16 17 18 19 20 21 22 23 24 25

A
B
C
D
E
F
G
H
J
K
L
M
N
P
R
T
U
V
W
Y
Z
AA
AB
AC
AD

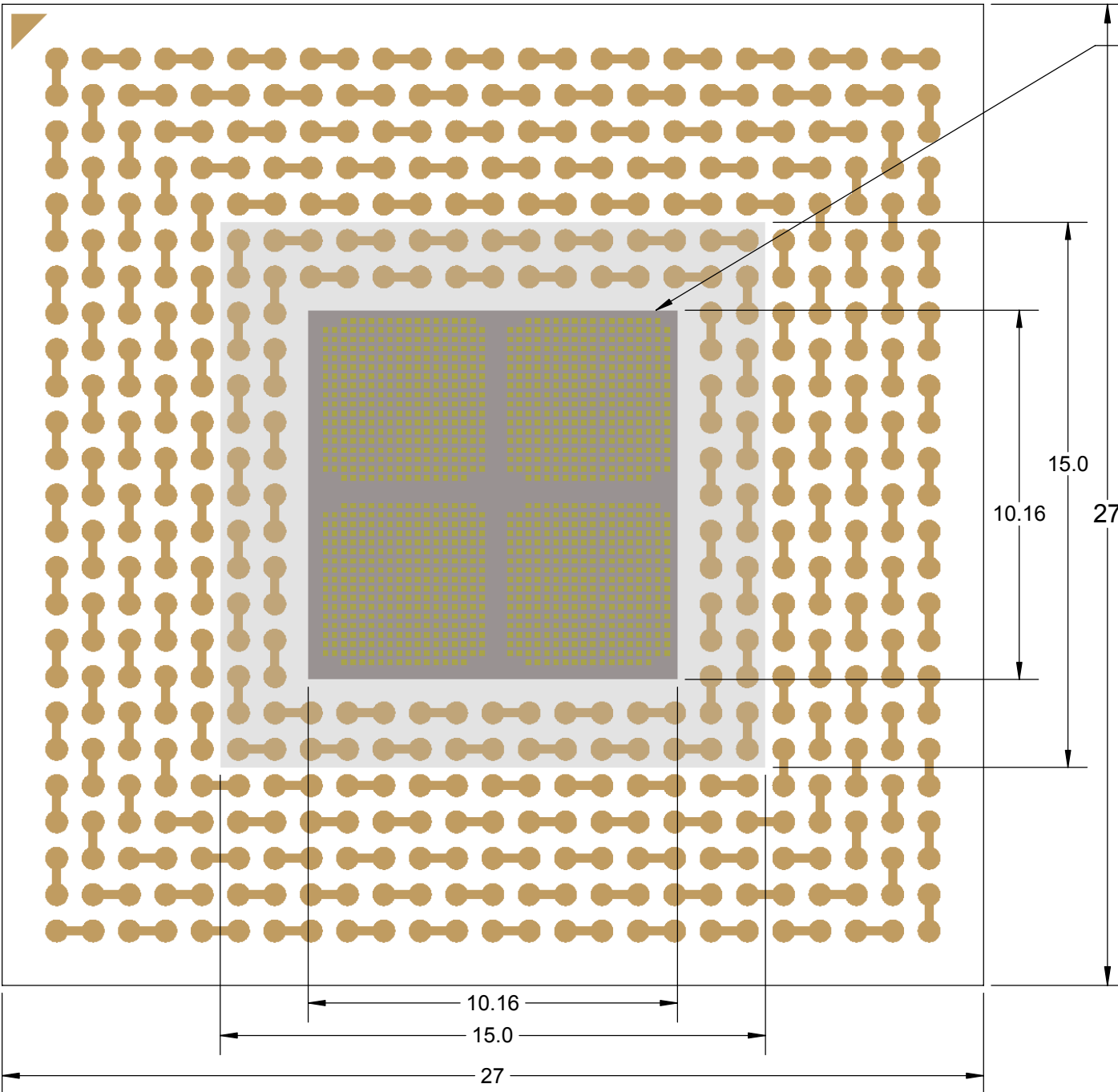

SEE DETAIL B
PAGE 16

15.0
10.16
27

10.16
15.0
27

TopLine[®]

TITLE SBGA625T1.0C-DC259D
DAISY CHAIN DUMMY

SCALE 4.5:1	SIZE A	DRAWING NO. 512595	REV A
----------------	-----------	-----------------------	----------

SOLDER MASK TOP

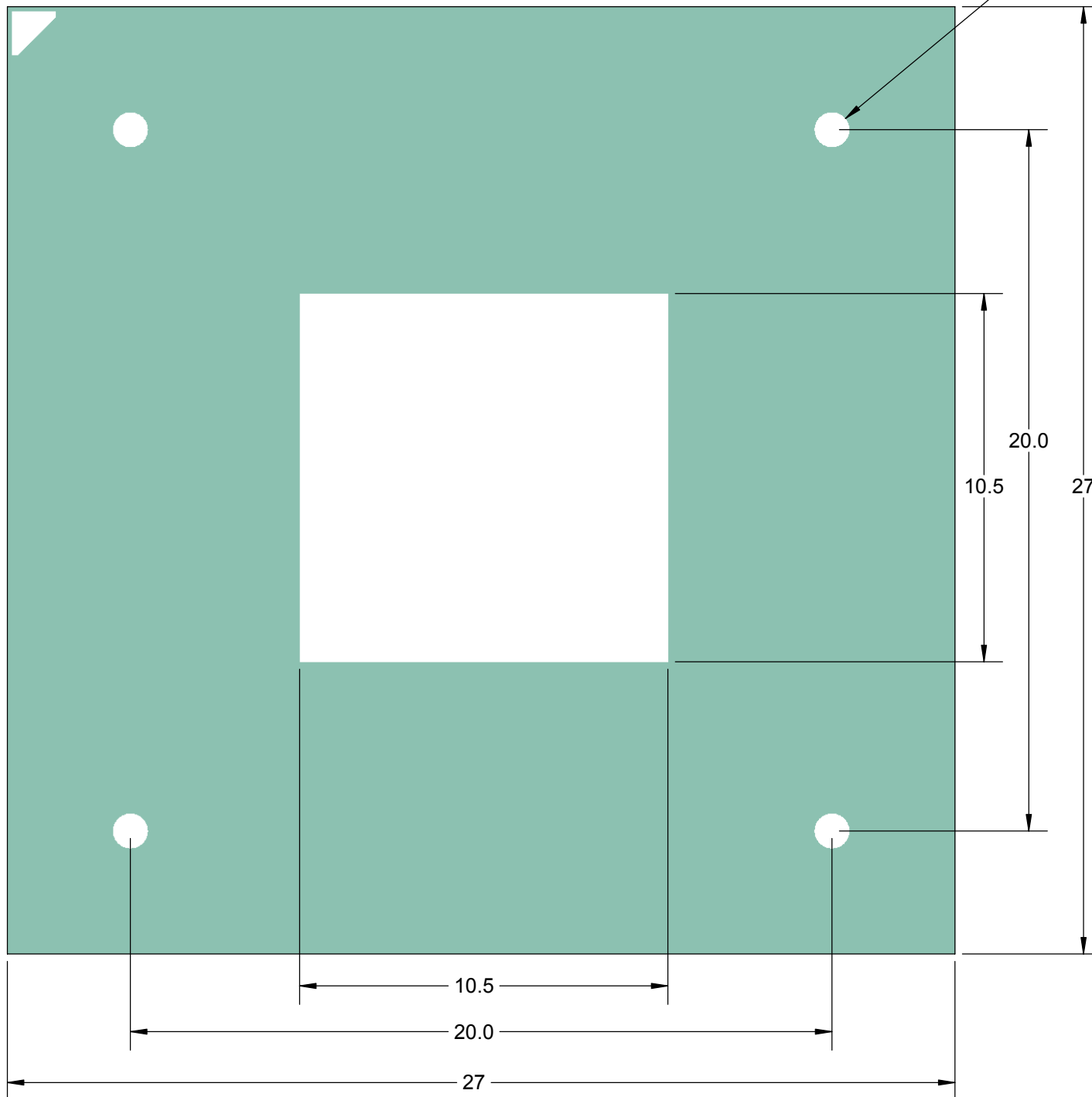

TopLine[®]			
TITLE SBGA625T1.0C-DC259D DAISY CHAIN DUMMY			
SCALE 4.5:1	SIZE A	DRAWING NO. 512595	REV A
DO NOT SCALE DRAWING			SHEET 11 OF 16

GROUND PLANE - LAYER 2

1 2 3 4 5 6 7 8 9 10 11 12 13 14 15 16 17 18 19 20 21 22 23 24 25

A
B
C
D
E
F
G
H
J
K
L
M
N
P
R
T
U
V
W
Y
Z
AA
AB
AC
AD

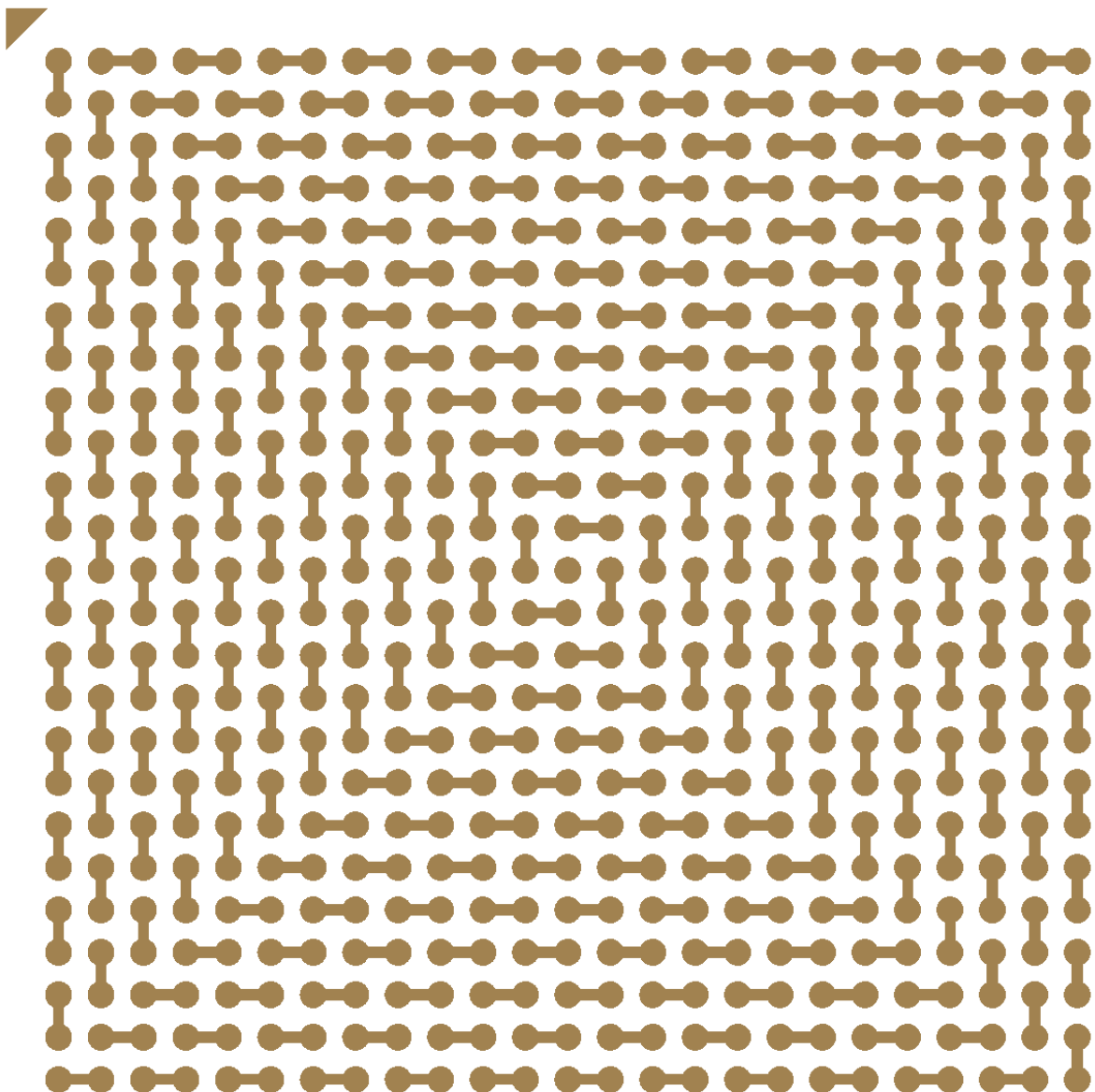

TopLine®			
TITLE SBGA625T1.0C-DC259D DAISY CHAIN DUMMY			
SCALE 4.5:1	SIZE A	DRAWING NO. 512595	REV A
DO NOT SCALE DRAWING			SHEET 12 OF 16

GROUND PLANE - LAYER 3

1 2 3 4 5 6 7 8 9 10 11 12 13 14 15 16 17 18 19 20 21 22 23 24 25

A
B
C
D
E
F
G
H
J
K
L
M
N
P
R
T
U
V
W
Y
Z
AA
AB
AC
AD

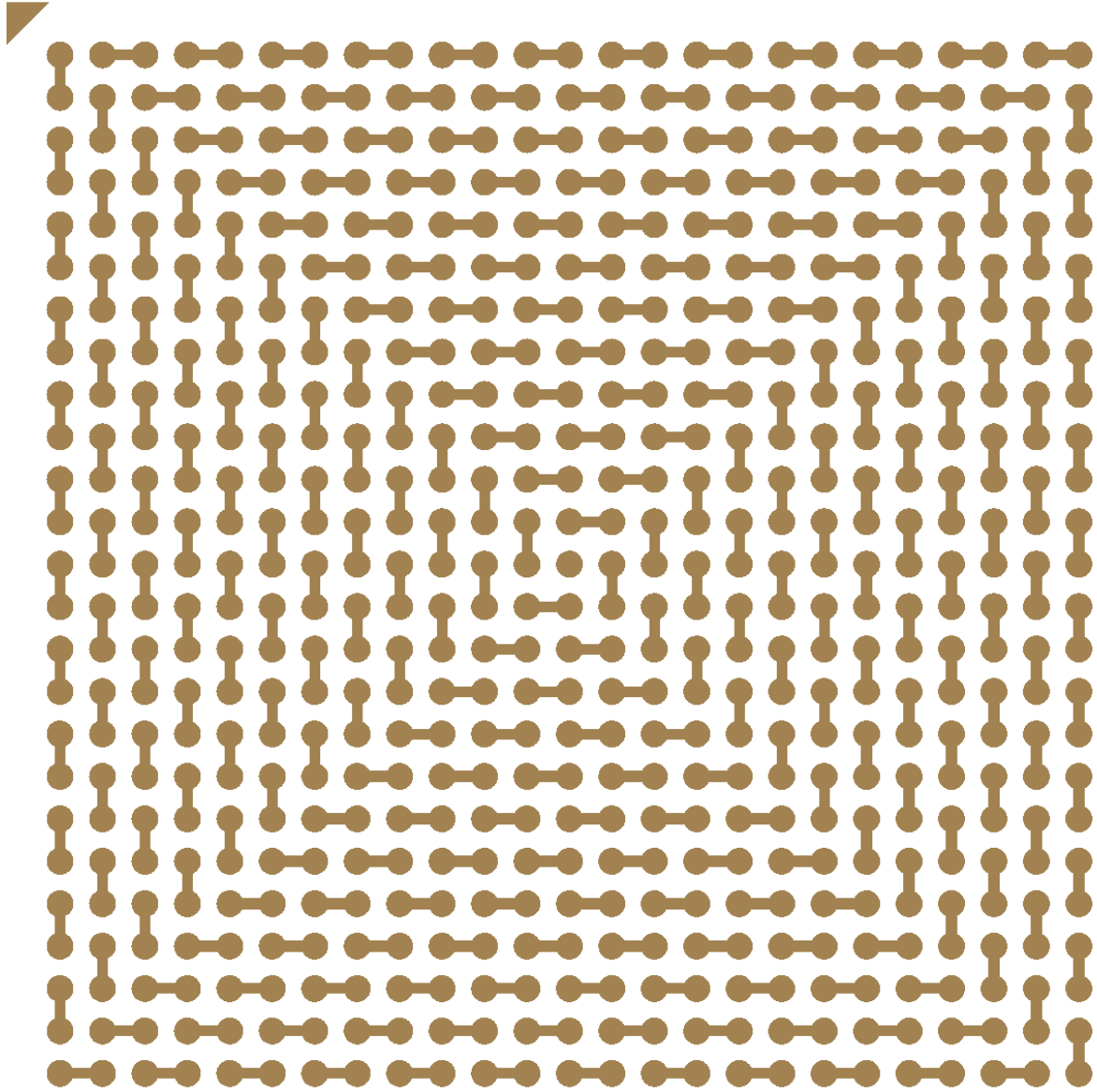

TopLine®			
TITLE SBGA625T1.0C-DC259D DAISY CHAIN DUMMY			
SCALE 4.5:1	SIZE A	DRAWING NO. 512595	REV A
DO NOT SCALE DRAWING			SHEET 13 OF 16

BOTTOM SIDE (TOP X-RAY VIEW) - LAYER 4

1 2 3 4 5 6 7 8 9 10 11 12 13 14 15 16 17 18 19 20 21 22 23 24 25

A
B
C
D
E
F
G
H
J
K
L
M
N
P
R
T
U
V
W
Y
Z
AA
AB
AC
AD

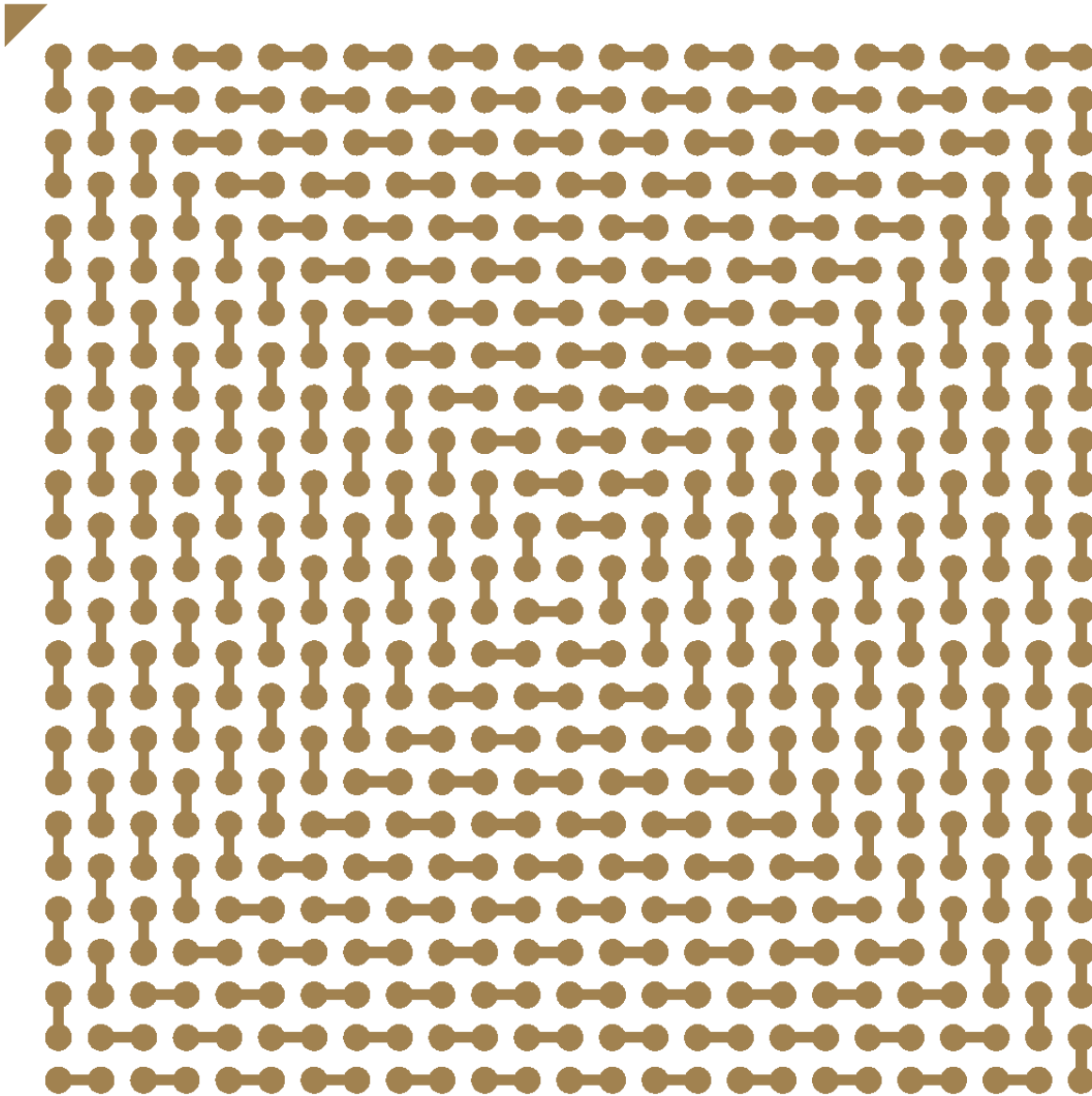

TopLine[®]			
TITLE SBGA625T1.0C-DC259D DAISY CHAIN DUMMY			
SCALE 4.5:1	SIZE A	DRAWING NO. 512595	REV A
DO NOT SCALE DRAWING			SHEET 14 OF 16

BOTTOM SOLDER MASK (RIGHT READING)

25 24 23 22 21 20 19 18 17 16 15 14 13 12 11 10 9 8 7 6 5 4 3 2 1

A
B
C
D
E
F
G
H
J
K
L
M
N
P
R
T
U
V
W
Y
Z
AA
AB
AC
AD

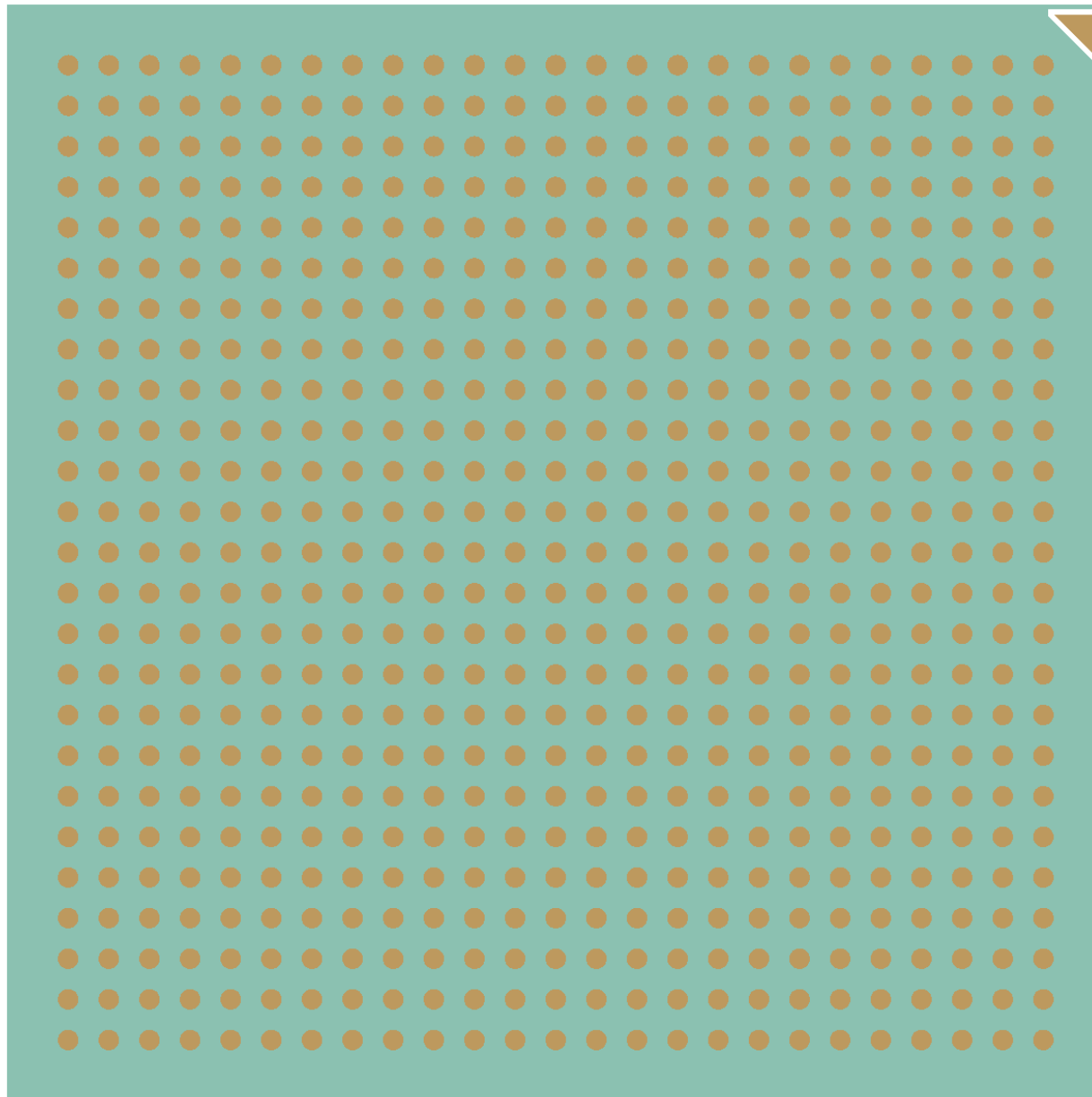

TopLine[®]			
TITLE SBGA625T1.0C-DC259D DAISY CHAIN DUMMY			
SCALE 4.5:1	SIZE A	DRAWING NO. 512595	REV A
DO NOT SCALE DRAWING			SHEET 15 OF 16

DETAIL B
PCB DIE PADS (TOP)
 Micron (μm)

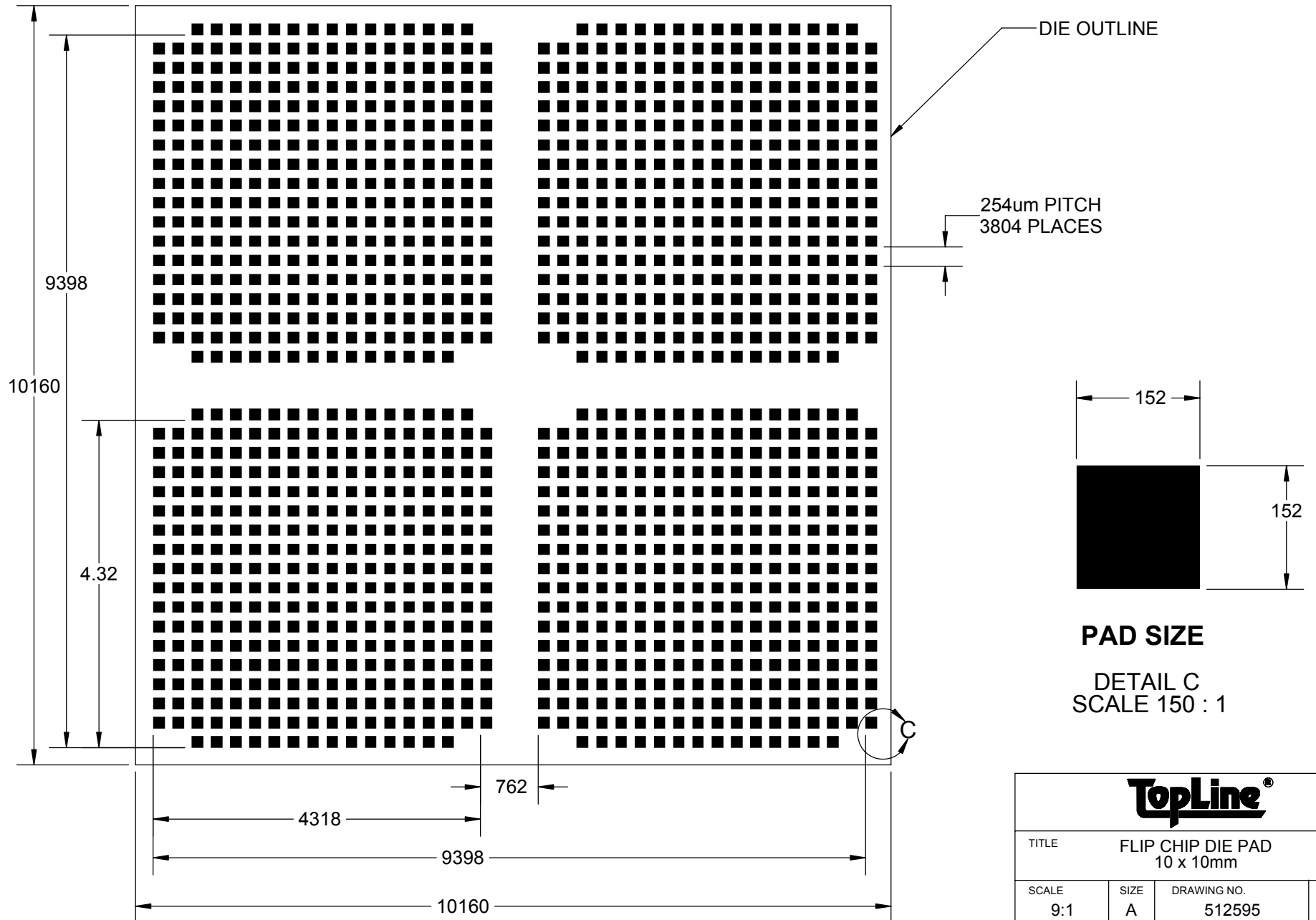

TopLine®			
TITLE		FLIP CHIP DIE PAD 10 x 10mm	
SCALE	SIZE	DRAWING NO.	REV
9:1	A	512595	A
DO NOT SCALE DRAWING			SHEET 16 OF 16