



2017 Catalog

HOW TO ORDER

PAYMENT TERMS

- Credit Terms (Net 30) for established customers.
- American Express, Mastercard and VISA accepted.

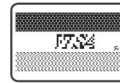

CONFIRMING PURCHASE ORDERS

- Confirming purchase orders are required for all orders over \$500.

MINIMUM PER ORDER

- USA/Canada \$50 minimum. • Export \$1000.

F.O.B. POINT AND SHIPPING

- F.O.B. ex-works TopLine USA. Please specify preferred method of shipment when placing order.

TopLine®

e-mail sales@topline.tv

www.topline.tv

95 Highway 22 W.





Milledgeville, GA 31061 USA

Toll Free USA/Canada 1-800-776-9888

Tel 1-478-451-5000

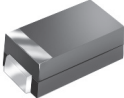
© 2017. TopLine. All Rights Reserved

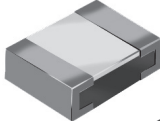
This catalog, or any parts thereof, must not be reproduced in any form without written permission of TopLine.

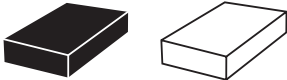
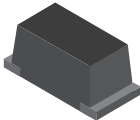
SERIES	DESCRIPTION	VIEW	WEBCODE	PAGE
SC	Ceramic Chip Capacitor		XD1	7
SD	Molded Tantalum		XD1	8
SE	Aluminum Capacitor		XD1	9
SR	Resistor Chip		XD1	10
SRM	Melf Resistor		XD1	11
SCC	Black & White Chips	 Edge 90°	XD1	12
SSL	Solderable Spacers		XD1	13

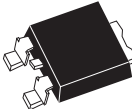
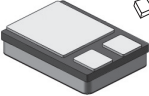
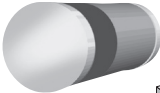
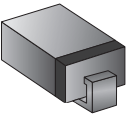
SERIES	DESCRIPTION	VIEW	WEBCODE	PAGE
SOT	Transistor		XD1	14
DPAK	Power Plastic Device		XD1	15
SMD	Power CERAMIC Device		XL1	15
SOD	Melf Diode/Rectifier		XD1	16
SMA~SMC	Rectangular Diode/Rectifier		XD1	17

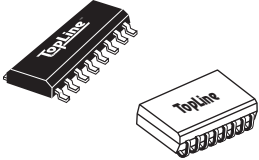
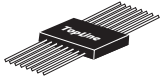
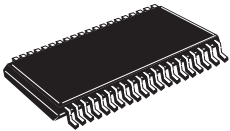
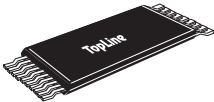
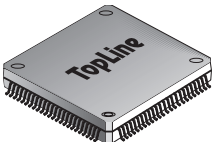
SERIES	DESCRIPTION	VIEW	WEB CODE	PAGE
PLCC	Chip Carrier		XP1	18
LCC	Chip Carrier		XL1	19
SOIC	Gull Wing		XS1	20
SOJ	J-Lead		XS1	21
FP	Flat Pack		XF1	22
MSOP	Mini Small Outline Package		XS1	23
SSOP	Shrink Small Outline Package		XS1	24
TSSOP	Thin Shrink Outline Package		XS1	25
TSOP	Type 1		XO1	26
TSOP	Type 2		XO1	27
TQFP	Thin Quad Flat Pack 1.0mm		XQ1	28
LQFP	Low Quad Flat Pack 1.4mm		XQ1	29
QFP	Quad Flat Pack		XQ1	30-31
CERQUAD	Ceramic Quad Flat Pack		XC1	32

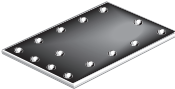
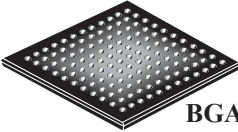
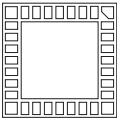
SERIES	DESCRIPTION	VIEW	WEB CODE	PAGE
W	Silicon Wafers & Die	 <p>FLIP CHIP</p>  <p>BGA</p>  <p>QFN</p>	XE1	33
TD	Test (Si) Die for Practice		XE1	156-157
FC	Flip Chip		Xi1	34-35
WLP - CSP	0.3mm Pitch			36
WLP - CSP	0.4mm Pitch			37-38
WLP - CSP	0.5mm Pitch			39-41
BGA	0.65mm, 0.75mm, 0.8mm Pitch			42-43
BGA	1.0mm Pitch			44-45
BGA	1.27mm Pitch		XJ1	46-47
CBGA	Ceramic 1.27mm Pitch			48-49
CCGA	Column Grid Array		50	
BGA	1.5mm Pitch		51	
BGA	Ball Count Chart		52	
eWLP	Embedded CSP Cu Post		53	
QFN	Quad Flat Lead		XU1	54-56
M-QFN	Open Cavity QFN		XH1	152-153

THROUGH HOLE DEVICES

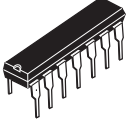
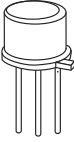
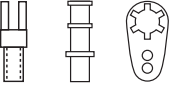
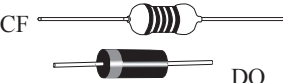
SERIES	DESCRIPTION	VIEW	WEB CODE	PAGE
DIP	Dual Inline Package	   	XN1	57
TO	Transistor		XT1	58
Terminal	Solder Terminals		XR1	59
CF & DO	Resistors & Diodes		XA1	60

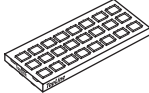

TRAYS

SERIES	DESCRIPTION	VIEW	WEB CODE	PAGE
	Waffle Pack for Bare Die 2" and 4"		XZ1	61
	JEDEC Matrix Component Trays		XZ1	62-64

	General Kit Information			
901~909	Flip Chip Kit	BALL & BUMP KITS	XK1	65-67
921	BGA46 0.75mm pitch			70-71
963	Universal CSP 0.5/0.75/0.8mm			72-73
981	Universal BGA 0.8/1.0mm pitch			74-75
9981	Universal BGA 0.8/1.0mm pitch			76-77
976	BGA 1.0mm & 0.8mm pitch			78-79
974	BGA256 1.0mm/SBGA560 1.27mm pitch			80-81
947	LBGA1600/1936 Very Large 1.0mm			82-83
937	Universal BGA Daisy Chain			84-85
967	BGA 256/272 1.27mm pitch			86-87
946	BGA169/225			88-89
958	Universal BGA 1.27/1.5mm pitch			90-91
951	LBGA1225 Very Large 1.27mm			92-93
986	Ceramic CBGA			94-95
	Lead Free Multicomponents	96-97		
919	Large Machine Run	FINE PITCH KITS	XK1	98-99
928	Challenger 2			100-101
950	SMTA SABER Array			102-103
935/936	Stencil Evaluation			104-105
975	QFN Daisy Chain			136-137
965	Rework 1 Practice	REWORK KITS	XK1	106-107
944	Rework 2 Practice			108-109
977	Rework 3 Practice			110-111
925	SMD Introductory	MIXED TECHNOLOGY KITS		112-113
926	Practical Mixed Technology			114-115
9696	Mixed Technology 1			116-117
914	Mixed Technology 2			118-119
938	Econo Kit II			142-143
939	Econo Kit III	MACHINE DIAGNOSTIC KITS	XK1	144-145
912	Econo IV Recertification			146-147
949	0201/0402 Chip Shooter			120-121
980	01005 / 0201 Chip Shooter			68-69
964	0402/0603 Chip Shooter			122-123
968	0805/1206 Chip Shooter			124-125
9618	Rotational Placement			134-135
931	Advanced QFP Assortment	QUAD FLAT PACK KITS	XK1	126-127
962	QFP Assortment			128-129
9625	QFP256 .4mm Pitch			130-131
9621	QFP208 .5mm Pitch			138-139

SOLDER PRACTICE KITS

SERIES	DESCRIPTION	VIEW	WEBCODE	PAGE
910	Beginners Throughhole	THROUGHHOLE KITS	XK1	138-139
913	12 Layer Daisy Chain			148-149
915~916	Multipurpose Throughhole			140-141
979	NASA Solder Practice			150

SERIES	DESCRIPTION	VIEW	PAGE
NN-SOL	Non-Collapsible Elastomer Core Solder Ball	 	151
CCGA Pin	Column Grid Array Solder Column		

BONDING WIRE

SERIES	DESCRIPTION	VIEW	WEBCODE	PAGE
GSA, TABN	Gold 4N and Aluminum Bonding Wire for Micro-Electronics		XV1	154-153

OPEN CAVITY QFN AIR CAVITY

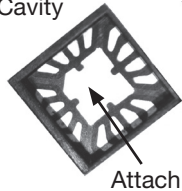
SERIES	DESCRIPTION	VIEW	WEBCODE	PAGE
M-QFN	Open (Air) Cavity QFN Package		XH1	152-153
TD	Test (Si) Die for Practice		XE1	156-157



CERAMIC CHIP CAPACITOR



Standard Terminal

DUMMY COMPONENT ORDERING INFORMATION

CHIP SIZE		TAPE INFO		4" (100mm)		7" (180mm)			
Inch	Metric	WIDTH	PITCH	XM1	Tape & Reel Part Number	QTY	XD1	Tape & Reel Part Number	QTY
STANDARD TERMINAL LEAD-FREE Sn100									
008004*	0201	4mm	1mm		SC008004E-W4P1	10,000		SC008004E7A-W4P1	50,000
01005*	0402	4mm	1mm		SC01005E-W4P1	5,000		SC01005E7A-W4P1	40,000
01005**	0402	8mm	2mm		SC01005P4A-TIN	1,000		SC01005P7A-TIN	20,000
0201	0603	8mm	2mm		SC0201P4A-TIN	1,000		SC0201P7A-TIN	15,000
0402	1005	8mm	2mm		SC0402P4A-TIN	500		SC0402P7A-TIN	10,000
0603	1608	8mm	4mm		SC0603P4A-TIN	500		SC0603P7A-TIN	4000
0805	2012	8mm	4mm		SC0805P4A-TIN	500		SC0805P7A-TIN	4000
1206	3216	8mm	4mm		SC1206P4A-TIN	500		SC1206P7A-TIN	4000
1210	3225	8mm	4mm		SC1210E4A-TIN	500		SC1210E7A-TIN	3000
1812	4532	12mm	8mm		SC1812E4A-TIN	100		SC1812E7A-TIN	1000
2225	5664	12mm	8mm		SC2225E4A-TIN	100		SC2225E7A-TIN	1000

*W4P1 New carrier. Width 4mm. Component pitch 1mm

**W8P2 Traditional tape width 8mm. Component pitch 2mm

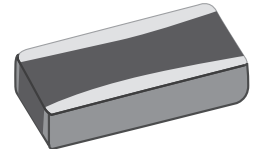

Wide Terminal

WIDE TERMINAL LEAD-FREE Sn100									
0204	0510	8mm	2mm		SC0204P4A-TIN	1000		SC0204P7A-TIN	15,000
0306	0816	8mm	4mm		SC0306P4A-TIN	500		SC0306P7A-TIN	4000
0508	1220	8mm	4mm		SC0508P4A-TIN	500		SC0508P7A-TIN	4000
0612	1632	8mm	4mm		SC0612P4A-TIN	500		SC0612P7A-TIN	4000

DIMENSION TOLERANCE L x W		HEIGHT (H)		HEIGHT (H)		HEIGHT (H)	
0201 ± 0.03mm	0805 ± 0.15mm	01005	0.2mm ± 0.03	0603	0.8mm ± 0.1	1210	1.25~1.5mm
0402 ± 0.05mm	1206 ± 0.15mm	0201	0.3mm ± 0.03	0805	0.6~1.25mm	1812	2.0mm MAX
0603 ± 0.1mm	1210 ± 0.30mm	0402	0.5mm ± 0.1	1206	0.6~1.25mm	2225	2.0mm MAX

**I
N
F
O**

Other sizes such as 0504, 1805, 1806, 2220 are available on special order

The chip size code is the component's LxW dimensions. Example: 0805 = .08" x .05".

Chip size may also be expressed in metric code. Example: 2012 = 2.0mm x 1.2mm.



Lead Free Option: Sn100 add -TIN to end of part number.

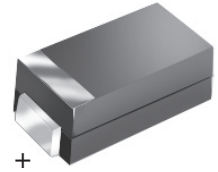

TANTALUM CAPACITOR MOLDED CASE



DUMMY COMPONENT ORDERING INFORMATION

CHIP SIZE		TAPE INFO		 Bulk Part Number QTY	4" (100mm)  Tape & Reel Part Number QTY		7" (180mm)  Tape & Reel Part Number QTY		
METRIC	CODE	WIDTH	PITCH		XM0	XM1	XD1	QTY	
3216	A	8mm	4mm	SD3216X-100	100	SD3216E4A	250	SD3216E7A	2000
3528	B	8mm	4mm	SD3528X-100	100	SD3528E4A	250	SD3528E7A	2000
6032	C	12mm	8mm	SD6032X-50	50	SD6032E4A	100	SD6032E7A	500
7343	D	12mm	8mm	SD7343X-50	50	SD7343E4A	100	SD7343E7A	500
1608	J	8mm	4mm	-	-	-	-	SD1608E7A	4000
2012	P/R	8mm	4mm	-	-	SD2012E4A	250	SD2012E7A	2500



DIMENSIONS			
CASE	LENGTH	WIDTH	HEIGHT
A	3.2mm	1.6mm	1.6mm
B	3.5mm	2.8mm	1.9mm
C	6.0mm	3.2mm	2.5mm
D	7.3mm	4.3mm	2.8mm
J	1.6mm	0.8mm	0.8mm
P/R	2.0mm	1.2mm	1.2mm

I Molded tantalum capacitors are available in six standard footprints. All sizes meet EIA/IECQ dimensions.
N The positive (+) terminal is oriented away from the sprocket holes.
O Nomenclature: The metric code specifies the LxW dimensions in millimeters. Example 3528 = 3.5mm x 2.8mm

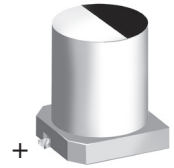
 Lead Free Option: Sn100 add -TIN to end of part number.



DUMMY COMPONENT ORDERING INFORMATION

CASE DIAMETER	MAXIMUM HEIGHT	TAPE INFO		7" (180mm)  Tape & Reel Part Number		13" (330mm)  Tape & Reel Part Number	
		WIDTH	PITCH	XM1	QTY	XD1	QTY
3mm	5.5mm	12mm	8mm	SE3E7A	100	SE3E13A	2000
4mm	5.5mm	12mm	8mm	SE4E7A	100	SE4E13A	2000
5mm	5.5mm	12mm	12mm	SE5E7A	100	SE5E13A	1000
6.3mm	5.5mm	16mm	12mm	SE6E7A	100	SE6E13A	1000
8mm	6.0mm	16mm	12mm	SE8E7A	100	SE8E13A	1000
8mm	10mm	24mm	16mm	SE9E7A	100	SE9E13A	500
10mm	10mm	24mm	16mm	SE10E7A	100	SE10E13A	300-500
10mm	17mm	32mm	20mm	-	-	SE11E13A	250-300
12.5mm	14mm	32mm	24mm	-	-	SE12E13A	200-250
12.5mm	17mm	32mm	24mm	-	-	SE13E13A	150-200
16mm	17mm	44mm	28mm	-	-	SE16E13A	125-150
16mm	22mm	44mm	28mm	-	-	SE17E13A	75-100
18mm	17mm	44mm	32mm	-	-	SE18E13A	125-150
18mm	22mm	44mm	32mm	-	-	SE19E13A	75-100
20mm	17mm	44mm	36mm	-	-	SE20E13A	50

I N F O Aluminum electrolytic capacitors are available in 16 case sizes. Aluminum capacitors are polarized devices and require proper orientation during placement. The negative terminal (black mark on top of component) faces the sprocket holes on the carrier tape. For 15" (380mm) reel change "E13A" to "E15P"

 Lead Free Option: Sn97/Bi3.0 add -SnBi to end of part number for 3mm ~ 10mm case diameter.

RESISTOR CHIP

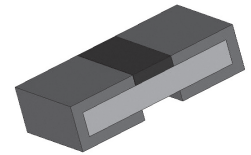
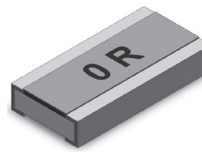
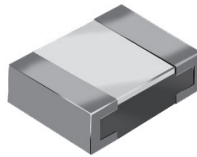

Standard Terminal

Wide Terminal

Embedded Terminal

DUMMY COMPONENT ORDERING INFORMATION

CHIP SIZE		TAPE INFO		4" (100mm)		7" (180mm)	
Inch	Metric	WIDTH	PITCH	XM1	Tape & Reel Part Number	XD1	QTY
STANDARD TERMINAL LEAD FREE Sn100							
-	03015	4mm	1mm		SR03015E-W4P1	SR0315E7A-W4P1	40,000
01005	0402	4mm	1mm		SR01005E4A-W4P1	SR01005E7A-W4P1	40,000
01005	0402	8mm	2mm		SR01005P4A-TIN	SR01005P7A-TIN	20,000
0201	0603	8mm	2mm		SR0201P4A-TIN	SR0201P7A-TIN	15,000
0402	1005	8mm	2mm		SR0402P4A-TIN	SR0402P7A-TIN	10,000
0603	1608	8mm	4mm		SR0603P4A-TIN	SR0603P7A-TIN	5,000
0805	2012	8mm	4mm		SR0805P4A-TIN	SR0805P7A-TIN	5,000
1206	3216	8mm	4mm		SR1206P4A-TIN	SR1206P7A-TIN	5,000
1210	3225	8mm	4mm		SR1210P4A-TIN	SR1210P7A-TIN	5,000
1812	4532	12mm	4mm		SR1812E4A-TIN	SR1812E7A-TIN	4,000
2010	5025	12mm	4mm		SR2010E4A-TIN	SR2010E7A-TIN	4,000
2512	6332	12mm	4mm		SR2512E4A-TIN	SR2512E7A-TIN	4,000
WIDE TERMINAL - ZERO OHM LEAD FREE Sn100							
0306	0816	8mm	4mm		SR0306P4A-ZERO-T	SR0306P7A-ZERO-T	5,000
0508	1220	8mm	4mm		SR0508P4A-ZERO-T	SR0508P7A-ZERO-T	5,000
0612	1632	8mm	4mm		SR0612P4A-ZERO-T	SR0612P7A-ZERO-T	5,000
0815	2037	12mm	4mm		SR0815E4A-ZERO-T	SR0815E7A-ZERO-T	5,000
1020	2550	12mm	4mm		SR1020E4A-ZERO-T	SR1020E7A-ZERO-T	5,000
1218	3245	12mm	4mm		SR1218E4A-ZERO-T	SR1218E7A-ZERO-T	4,000
1225	3264	12mm	4mm		SR1225E4A-ZERO-T	SR1225E7A-ZERO-T	4,000
2030	5176	16mm	8mm		SR2030E7A-ZERO-T	SR2030E7A-ZERO-T	1,000
EMBEDDED RESISTOR - ZERO OHM - COPPER TERMINAL (150UM HEIGHT)							
01005	0402	8mm	2mm		eSR01005P4A-ZERO-Cu	eSR01005P7A-ZERO-Cu	20,000
0201	0603	8mm	4mm		eSR0201P4A-ZERO-Cu	eSR0201P7A-ZERO-Cu	15,000
0402	1005	8mm	4mm		eSR0402P4A-ZERO-Cu	eSR0402P7A-ZERO-Cu	10,000

DIMENSION TOLERANCE

0402 ± 0.05mm
0603 ~ 2512 ± 0.15mm

HEIGHT (H)

01005	0.12mm ± 0.02	0603	0.45mm ± 0.10	1210	0.55mm ± 0.15
0201	0.23mm ± 0.03	0805	0.55mm ± 0.1	2010	0.55mm +/-0.15
0402	0.35mm ± 0.05	1206	0.55mm ± 0.1	2512	0.55mm +/-0.15

I Resistor chips are available in seven standard sizes. Bulk Feeder cassettes are for placement by high-speed chip shooters. Zero ohm jumpers available for continuity checking.

N The chip size code approximates the LxW dimensions in inches. Example: 0805 = .08" x .05".

O Lead Free Option: Sn100 add -TIN to end of part number.



DUMMY COMPONENT ORDERING INFORMATION

SIZE CODE		SIZE LENGTH X DIA.	TAPE INFO		4" (100mm) Tape & Reel Part Number		7" (180mm) Tape & Reel Part Number	
INCH	NAME		WIDTH	PITCH	XM1	QTY	XD1	QTY
LEAD FREE		Sn100 PLASTIC TAPE						
0604		1.6 x 1.0mm	8mm	4mm	SRM0604E4A-TIN	500	SRM0604E7A- TIN	3000
0805	Micro	2.2 x 1.1 mm	8mm	4mm	SRM0805E4A-TIN	500	SRM0805E7A- TIN	3000
1206	Mini	3.2 x 1.6mm	8mm	4mm	SRM1206E4A-TIN	500	SRM1206E7A- TIN	3000
1406	Mini	3.5 x 1.4mm	8mm	4mm	SRM1406E4A-TIN	500	SRM1406E7A- TIN	3000
2308	MELF	5.9 x 2.2mm	12mm	4mm	SRM2308E4A-TIN	250	SRM2308E7A- TIN	1.5~2K
3512	Maxi	8.5 x 3.0mm	16mm	8mm	SRM3512E7A-TIN	500	SRM3512E13A-TIN	2500
4213	Maxi	10.5 x 4.0mm	16mm	8mm	SRM4213E7A- TIN	500	SRM4213E13A- TIN	2000
ZERO OHM								
0805	Micro	2.2 x 1.1mm	8mm	4mm	SRM0805E4A-ZERO	500	SRM0805E7A-ZERO	3000
1206	Mini	3.2 x 1.6mm	8mm	4mm	SRM1206E4A-ZERO	500	SRM1206E7A-ZERO	3000
2308	MELF	5.9 x 2.2mm	12mm	4mm	SRM2308E4A-ZERO	250	SRM2308E7A-ZERO	1.5~2K
3512	Maxi	8.5 x 3.0mm	16mm	8mm	SRM3512E7A-ZERO	500	SRM3512E13A-ZERO	2500
4213	Maxi	10.5 x 4.0mm	16mm	8mm	SRM4213E7A-ZERO	500	SRM4213E13A-ZERO	2000

Cross Reference

Code	TopLine
0102	SRM0805
0204	SRM1206
0207	SRM2308
201	SRM3513
301	SRM4213

I MELF resistors are cylindrical. Extra care is required during placement to prevent rolling during assembly. These
N devices are often called by their nicknames relative to size such as micro-melf, mini-melf and melf. Nomenclature:
F MELF = Metal Electrode Face Bonded. Lead Free version is tin over nickel plating.
O

Lead Free Option: Sn100 add -TIN to end of part number.



BLACK & WHITE CERAMIC CHIPS FOR CALIBRATION

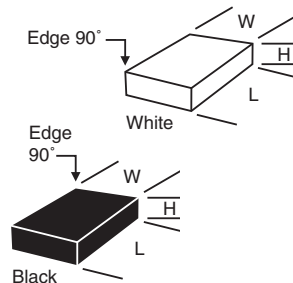

DUMMY COMPONENT ORDERING INFORMATION

CHIP SIZE		TAPE MAT'L	TAPING INFO		7" (180mm) Tape & Reel Part Number	QTY
INCH	METRIC		WIDTH	PITCH		
WHITE CHIPS						
0201	0603	Paper	8mm	2mm	SCC0201P7A-WHITE	15,000
0402	1005	Paper	8mm	2mm	SCC0402P7A-WHITE	10,000
0603	1608	Paper	8mm	4mm	SCC0603P7A-WHITE	4,000
0805	2012	Plastic	8mm	4mm	SCC0805P7A-WHITE	4,000
1206	3216	Paper	8mm	4mm	SCC1206P7A-WHITE	4,000
BLACK CHIPS						
0201	0603	Paper	8mm	2mm	SCC0201P7A-BLACK	15,000
0402	1005	Paper	8mm	2mm	SCC0402P7A-BLACK	10,000
0603	1608	Paper	8mm	4mm	SCC0603P7A-BLACK	4,000
0805	2012	Plastic	8mm	4mm	SCC0805E7A-BLACK	4,000
1206	3216	Paper	8mm	4mm	SCC1206P7A-BLACK	4,000

INCH DIMENSIONS:

Inch Code	L	W	H	Tol
0201	0.0225	0.0115	0.0115	+/- 0.001
0402	0.036	0.019	0.019	+/- 0.003
0603	0.058	0.031	0.029	+/- 0.003
0805	0.075	0.052	0.037	+/- 0.003
1205	0.119	0.060	0.048	+/- 0.003

METRIC DIMENSIONS:

Metric Code	L	W	H	Tol
0603	0.57	0.29	0.29	+/- 0.025
1005	0.91	0.48	0.48	+/- 0.076
1608	1.47	0.79	0.74	+/- 0.076
2012	1.91	1.32	0.94	+/- 0.076
3216	3.02	1.52	1.22	+/- 0.076

I Placement Ceramic Chips are available in 6 case sizes and in 2 colors: White and Black.
N Right angle 90° edges for accurate placement by vision equipment. No terminations. Non-Solderable.
F White chips are mounted on a dark substrate such as blue Nitto tape.
O Black chips are mounted on a light substrate. Excellent contrast. Easy for vision equipment to see.



SOLDERABLE SPACERS STANDOFF INSULATOR Bottom Terminal

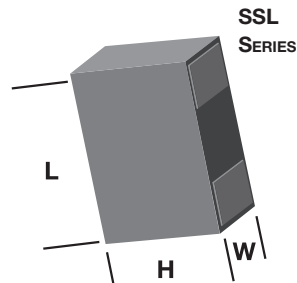

DUMMY COMPONENT ORDERING INFORMATION

L METRIC	W METRIC	BODY MAT'L	HEIGHT (H)		XD1  Tape & Reel Part Number	QTY
			INCH	METRIC		
3.2mm	1.6mm	FR4	+/- 10%			
			0.050	1.3mm	SSL120650E7A-T	1000
			0.060	1.6mm	SSL120660E7A-T	1000
			0.075	1.9mm	SSL120675E7A-T	1000
			0.080	2.0mm	SSL120680E7A-T	1000
			0.095	2.4mm	SSL120695E7A-T	1000
			0.120	3.2mm	SSL1206120E13A-T	1000

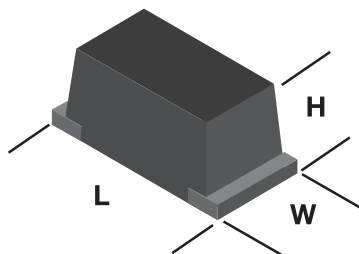

SOD123FW
SMAF
SMBF
SMCF

L	W	MAT'L	H - INCH	H - MM	PART NUMBER	QTY
3.5 ~ 3.9mm	1.5 ~ 1.9mm	Molded Plastic	0.050 - 0.067	1.3~1.7mm	SOD123FW-E7A-T-ISO	2500
4.5 ~ 4.9mm	2.3 ~ 2.7mm		0.060~0.070	1.5~1.8mm	SMAF-E7A-T-ISO	2000
5.0 ~ 5.4mm	3.2 ~ 3.6mm		0.067~0.075	1.7~1.9mm	SMBF-E13A-T-ISO	4000
6.3 ~ 6.9mm	4.2 ~ 4.8mm		0.075~0.10	1.9~2.5mm	SMCF-E13A-T-ISO	3000

SSL solderable spacers are constructed with high grade RoHS FR4. Bottom tin (Sn) plated copper (Cu) terminals provide compact footprint. Custom sizes available.

SOD, SMA, SMB and SMC (ISO suffix) solderable spacers are fully isolated open circuit - no internal connections . Constructed with wide tin (Sn) copper (Cu) terminals to provide strong attachment to PCB. Optional (DC12 suffix) fully shorted zero ohm jumpers are available.

O T F



SOT TRANSISTOR

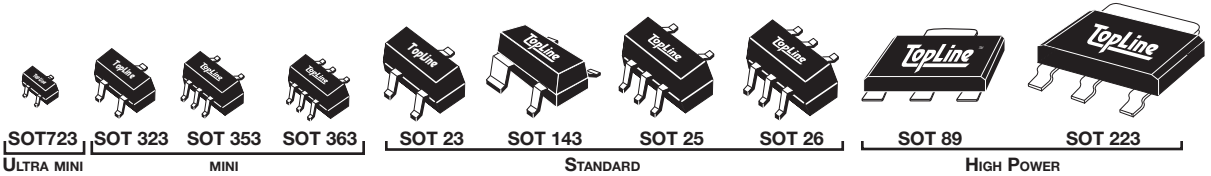

DUMMY COMPONENT ORDERING INFORMATION

NBR LEADS	TAPE INFO		DEVICE REFERENCE			BODY SIZE NOMINAL (MM)				4" (100mm) Tape & Reel Part Number		7" (180mm) Tape & Reel Part Number	
	WIDTH	PITCH	SOT	SC	TO	A	B	S	H	XM1	QTY	XD1	QTY
3	8mm	4mm	SOT723	-	-	1.2	0.8	1.2	0.5	-	-	SOT723E7A	8000
3	8mm	4mm	SOT346	SC59	TO236AA	2.9	1.6	2.8	1.1	-	-	SC59E7A	3000
3	8mm	4mm	SOT323	SC70	-	2.0	1.25	2.1	0.9	-	-	SC70E7A	3000
3	8mm	4mm	SOT416	SC75A/SC90	-	1.6	0.8	1.6	0.7	-	-	SC90E7A	3000
3	8mm	4mm	SOT523F	-	-	1.6	0.8	1.6	0.7	-	-	SOT523E7A	3000
3	8mm	4mm	SOT23	-	TO236AB	2.9	1.3	2.4	.95	SOT23E4A	500	SOT23E7A	3000
5	8mm	4mm	SOT23-5	SC74A	-	2.9	1.6	2.8	1.1	SOT25E4A	500	SOT25E7A	3000
6	8mm	4mm	SOT23-6	SC74	SOT457	2.9	1.6	2.8	1.1	SOT26E4A	500	SOT26E7A	3000
3	12mm	8mm	SOT89	SC62	TO243AA	4.5	2.5	4.0	1.5	SOT89E4A	200	SOT89E7A	1000
4	8mm	4mm	SOT143	-	TO253AA	2.9	1.6	2.8	.95	SOT143E4A	500	SOT143E7A	3000
3	16mm	8mm	SOT223	SC73	TO261AA	6.5	3.6	7.0	1.6	SOT223E4A	100	SOT223E13A	2500
3	8mm	4mm	SOT323	SC70	-	2.0	1.25	2.1	0.9	SOT323E4A	500	SOT323E7A	3000
4	8mm	4mm	SOT343	SC82A	-	2.0	1.25	2.1	0.9	-	-	SOT343E7A	3000
5	8mm	4mm	SOT353	SC88A	-	2.0	1.25	2.1	0.9	SOT353E4A	500	SOT353E7A	3000
6	8mm	4mm	SOT363	SC88	-	2.0	1.25	2.1	0.9	SOT363E4A	500	SOT363E7A	3000
8	8mm	4mm	SOT23-8	-	-	2.9	1.6	2.9	1.2	-	-	SOT28E7A	3000

Daisy Chain - TopView

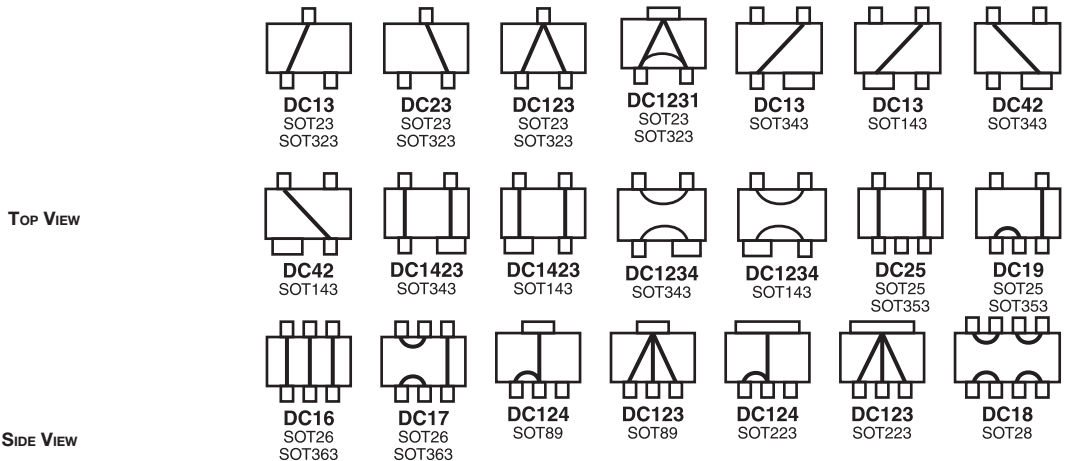

TopLine offers a full range of SOT devices conforming to JEDEC (TO) and EIAJ (SC) standards. 3-lead devices are commonly used for diodes or transistors. 5- and 6-lead devices are used for integrated circuits or diode arrays. Nomenclature: SOT = Small Outline Transistor. AEC-Q100 are MIL-S-883 standards available.

Lead Free Option: Sn100 add -TIN to end of part number.

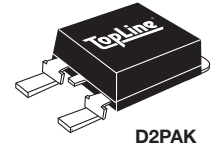
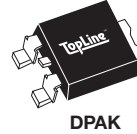

DUMMY COMPONENT ORDERING INFORMATION

PACKAGE SIZE NOMINAL (MM)				JEDEC SMD DEVICE	TAPE INFO		7" (180mm) Tape & Reel Part Number		13" (330mm) Tape & Reel Part Number	
L	W	H	S		WIDTH	PITCH	XM1	QTY	XD1	QTY
6	6.5	2.3	10	TO-252AA	16mm	8mm	DPAK-E7A	100	DPAK-E13A	2500
9.2	10	4.4	15	TO-263AB	24mm	16mm	D2PAK-E7A	100	D2PAK-E13A	500~800
9.2	10	4.4	15	5-LEAD	24mm	16mm	-	-	D2PAK-5-E13A	500~800

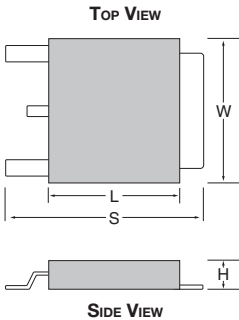

Daisy Chain Options

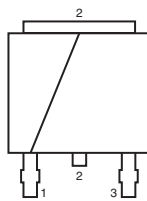

DC12
DPAK
D2PAK

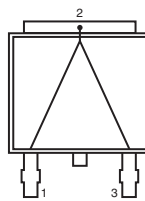

DC123
DPAK
D2PAK

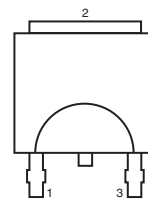

DC13
DPAK
D2PAK

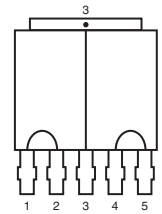

DC1245
D2PAK5

INFO DPAKs are large packages used for power devices such as rectifiers and transistors. The D²PAK is the Surface Mount equivalent of the TO-220. Lead Free Option: Sn100 add -TIN to end of part number.

SMD POWER DEVICE (CERAMIC)

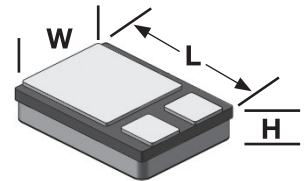

DUMMY COMPONENT ORDERING INFORMATION

PACKAGE SIZE NOMINAL (MM)			JEDEC SMD DEVICE	OPEN CAVITY WITHOUT LID	DUMMY WITH LID ATTACHED	DAISY CHAIN PACKAGE LID ATTACHED		
L	W	H		XL1	XL1	QTY	XL1	QTY
10.16	7.52	2.8	TO-276AA	SMD.5-N	SMD.5	1	SMD.5-DC123	1
15.88	11.43	3.3	TO-276AB	SMD1-N	SMD1	1	SMD1-DC123	1
17.52	13.34	3.3	TO-276AC	SMD2-N	SMD2	1	SMD2-DC123	1

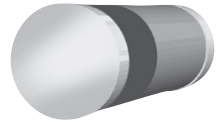

DUMMY COMPONENT ORDERING INFORMATION

DEVICE	SIZE DIA. x L	TAPE INFO		4" (100mm) Tape & Reel Part Number QTY		7" (180mm) Tape & Reel Part Number QTY		13" (330mm) Tape & Reel Part Number QTY	
		WIDTH	PITCH	XM1	QTY	XD1	QTY	XD1	QTY
mini MELF DO-213AA (LL34)	1.6 x 3.5mm	8mm	4mm	SOD80E4A	500	SOD80E7A	2500	SOD80E13A	10,000
MELF DO-213AB (LL35/LL41)	2.5 x 5mm	12mm	4mm	SM1E4A-GLASS	250	SM1E7A-GLASS	1500	SM1E13A-GLASS	5000
MELF DO-213AB (SM1)	2.5 x 5mm	12mm	4mm	SM1E4A-PLASTIC	250	SM1E7A-PLASTIC	1750	SM1E13A-PLASTIC	5000

Daisy Chain (Optional)

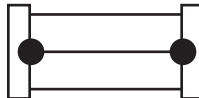

DC12

RECTANGULAR DIODE

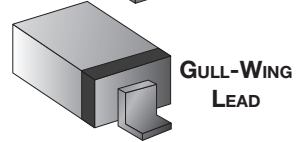
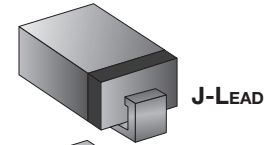
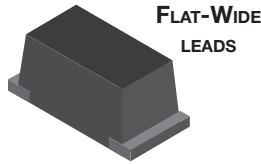

DUMMY COMPONENT ORDERING INFORMATION

PACKAGE SIZE NOMINAL (MM)					JEDEC DEVICE	TAPE WIDTH		7" (180mm) Tape & Reel Part Number		13" (330mm) Tape & Reel Part Number	
L	W	H	S	B		WIDTH	PITCH	XD1	QTY	XD1	QTY
FLAT-NARROW LEADS											
0.8	0.6	0.4	1.0	0.2	SOD923	8mm	2mm	SOD923E7A	8000	-	-
1.0	0.6	0.5	1.4	0.3	SOD723	8mm	2mm	SOD723E7A	8000	-	-
1.2	0.8	0.6	1.6	0.3	SOD523	8mm	4mm	SC79E7A	3000	-	-
1.2	0.8	0.6	1.6	0.3	SOD523	8mm	4mm	SOD523E7A	3000	-	-
FLAT-WIDE LEADS											
3.2	1.6	1.5	3.6	1.6	DO219AA	8mm	4mm	SOD123FW-E7A	2500	-	-
4.0	2.5	1.6	4.7	2.5	SOD128	12mm	4mm	SMAF-E7A	2000	SMAF-E13A	7500
4.5	3.5	1.8	5.2	3.5	-	12mm	8mm	-	-	SMBF-E13A	4000
6.0	4.5	2.3	6.7	4.5	-	12mm	8mm	-	-	SMCF-E13A	3000
GULL WING LEADS											
1.7	1.25	0.7	2.5	0.3	SOD323	8mm	4mm	SOD323E7A	3000	-	10,000
2.7	1.5	1.3	3.6	0.7	SOD123	8mm	4mm	SOD123E7A	3000	-	-
4.3	2.6	2.2	6.1	1.4	DO215AC	12mm	4mm	SMAG-E7A	1800	SMAG-E13A	-
4.3	3.6	2.3	6.2	2.0	DO215AA	12mm	8mm	SMBG-E7A	1000	SMBG-E13A	2500
7.0	6.0	2.3	10	3.0	DO215AB	16mm	8mm	SMCG-E7A	900	SMCG-E13A	2500
J-LEAD											
4.3	2.6	2.2	5.0	1.5	DO214AC	12mm	4mm	SMAJ-E7A	1800	SMAJ-E13A	5000 - 7500
4.3	3.6	2.3	5.4	2.0	DO214AA	12mm	8mm	SMBJ-E7A	750	SMBJ-E13A	3000 - 3200
7.0	6.0	2.3	8.0	3.0	DO214AB	16mm	8mm	SMCJ-E7A	850	SMCJ-E13A	3000 - 3500

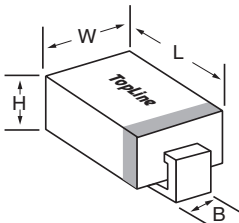

J-LEAD

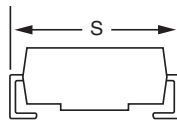

SIDE VIEW

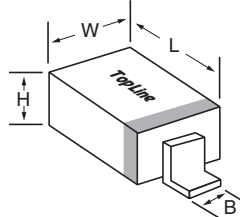

GULL WING LEAD

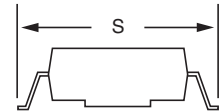

SIDE VIEW

Daisy Chain, add -DC12 to end of part number.

Rectangular diodes Gull-wing, J-LEAD or Flat Leads (Narrow and wide versions)

Lead Free Option add -TIN to end of part number.



PLCC PLASTIC LEADED CHIP CARRIER

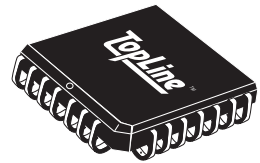

J-LEAD 50MIL PITCH

DUMMY COMPONENT ORDERING INFORMATION

NBR LEADS	BODY SIZE INCHES	TAPE INFO		Tube Part Number		7" (180mm) Tape & Reel Part Number		13" (330mm) Tape & Reel Part Number	
		WIDTH	PITCH	XP1	QTY	XM1	QTY	XP1	QTY
*18	.29" x .43"	24mm	12mm	PLCC18SM	36	-	-	-	-
18	.29" x .49"	24mm	12mm	PLCC18M	36	PLCC18E7A	100	PLCC18E13A	1000
20	.35" sq.	16mm	12mm	PLCC20M	46~50	PLCC20E7A	100	PLCC20E13A	1000
28	.45" sq.	24mm	16mm	PLCC28M	37~40	PLCC28E7A	100	PLCC28E13A	500-1000
32	.45" X .55"	24mm	16mm	PLCC32M	30~34	PLCC32E7A	100	PLCC32E13A	500-750
44	.65" sq.	32mm	24mm	PLCC44M	25~28	PLCC44E7A	100	PLCC44E13A	400-500
52	.75" sq.	32mm	24mm	PLCC52M	24~25	PLCC52E7A	50	PLCC52E13A	500
68	.95" sq.	44mm	32mm	PLCC68M	17~20	PLCC68E7A	50	PLCC68E13A	250
84	1.15" sq.	44mm	36mm	PLCC84M	14~17	PLCC84E7A	50	PLCC84E13A	250

*PLCC18S short version is an obsolete design.

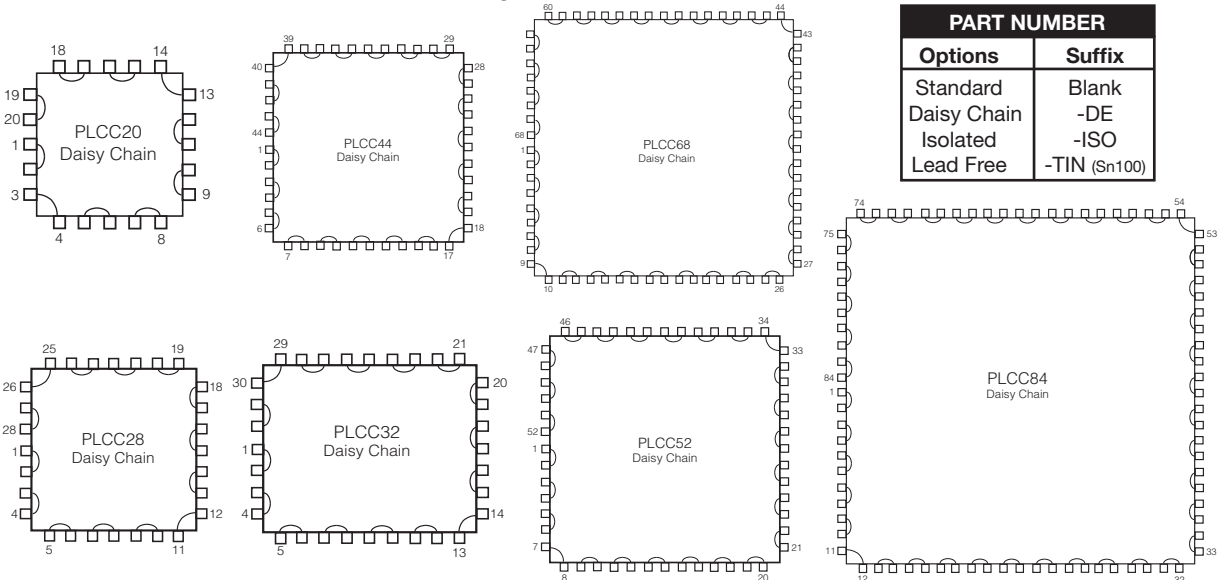

PART NUMBER	
Options	Suffix
Standard	Blank
Daisy Chain	-DE
Isolated	-ISO
Lead Free	-TIN (Sn100)

TOPLINE

Standard plating on leads is Sn85/Pb15. Lead pitch is 50 mils (1.27mm). Tube and reel quantities may vary. For completely isolated (no internal connections) add - ISO to the end of part number.

Lead Free. Add suffix to part number: -Tin = Sn100

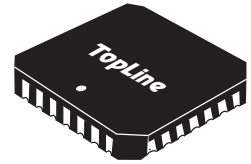

DUMMY COMPONENT ORDERING INFORMATION

NBR LEADS	LEAD PITCH		CASE SIZES		XL1	 Bulk Part Number
	INCH	METRIC	INCH	METRIC		
3	75 mils	1.90mm	.12 x 10	3.05 x 2.54		LCC3R.12x10
4	50 mils	1.27mm	.22 x .15	5.6 x 3.8		LCC4R.15x.22
6	50 mils	1.27mm	.25 x .17	6.22 x 4.32		LCC6R.17x.25
20	50 mils	1.27mm	.35" SQ	8.89mm		LCC20B50SQ.35
28	50 mils	1.27mm	.45" SQ	11.3mm		LCC28B50SQ.45
32	50 mils	1.27mm	.45" x .55"	11.3 x 14mm		LCC32B50R.45x.55
44	50 mils	1.27mm	.65" SQ	16.5mm		LCC44B50SQ.65
52	50 mils	1.27mm	.75" SQ	19.1mm		LCC52B50SQ.75
68	50 mils	1.27mm	.95" SQ	24.1mm		LCC68B50SQ.95
84	50 mils	1.27mm	1.15" SQ	29.2mm		LCC84B50SQ1.15

OPTIONAL DAISY CHAIN

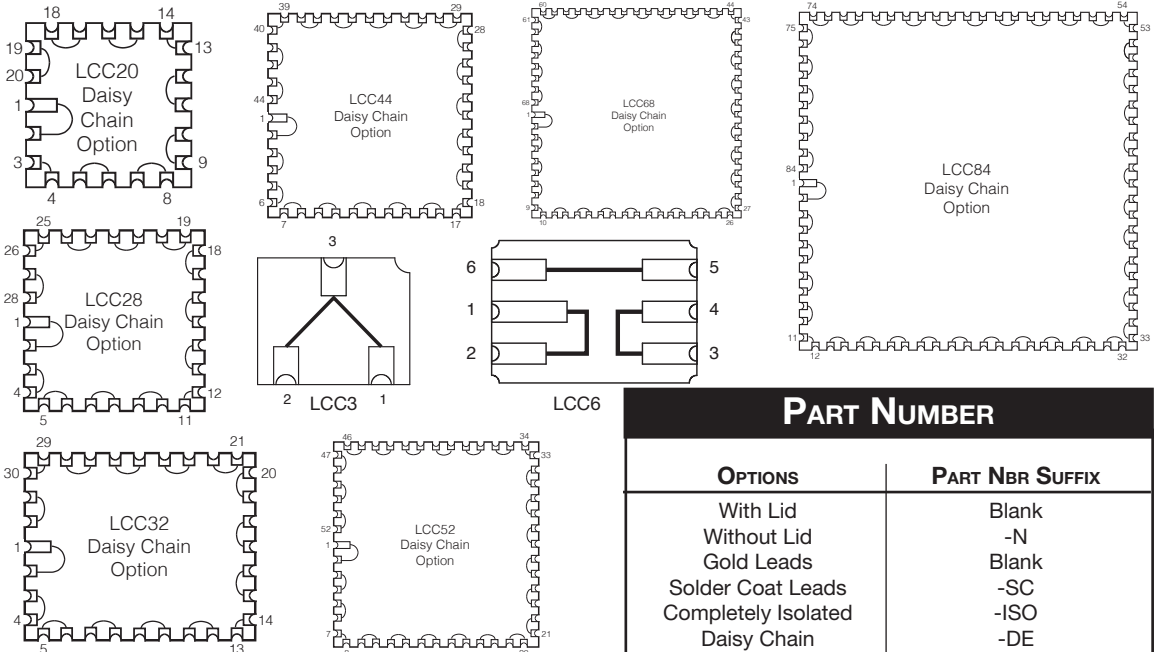

PART NUMBER

OPTIONS	PART NBR SUFFIX
With Lid	Blank
Without Lid	-N
Gold Leads	Blank
Solder Coat Leads	-SC
Completely Isolated	-ISO
Daisy Chain	-DE



SO - SMALL OUTLINE GULL WING

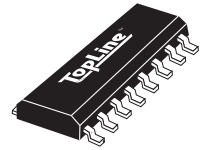

50 MIL PITCH (1.27MM)



DUMMY COMPONENT ORDERING INFORMATION

NBR LEADS	BODY WIDTH		TAPE INFO		XS1	Tube Part Number QTY	7" (180mm)		13" (330mm)	
	MILS	METRIC	WIDTH	PITCH			XM1	Tape & Reel Part Number QTY	XS1	Tape & Reel Part Number QTY
8	150	3.9mm	12mm	8mm	SO8M	96~100	SO8E7A	100	SO8E13A	2500
8	210	5.3mm	16mm	12mm	SOP8M	100	-	-	SOP8E13A	2000
14	150	3.9mm	16mm	8mm	SO14M	50~56	SO14E7A	100	SO14E13A	2500
14	208	5.3mm	16mm	12mm	SOP14M	46~58	-	-	SOP14E13A	2000
14	220	5.6mm	24mm	12mm	SOM14M	46~58	-	-	SOM14E13A	2000
16	150	3.9mm	16mm	8mm	SO16M	45~50	SO16E7A	100	SO16E13A	2500
16	208	5.3mm	16mm	12mm	SOP16M	42	-	-	SOP16E13A	2000
16	220	5.6mm	24mm	12mm	SOM16M	42	SOM16E7A	100	SOM16E13A	2000
16	300	7.5mm	16mm	12mm	SOL16M	47	SOL16E7A	100	SOL16E13A	1000
18	300	7.5mm	24mm	12mm	SOL18M	41~42	-	-	SOL18E13A	1000
20	300	7.5mm	24mm	12mm	SOL20M	38	SOL20E7A	100	SOL20E13A	1000
24	300	7.5mm	24mm	12mm	SOL24M	31~33	SOL24E7A	100	SOL24E13A	1000
28	300	7.5mm	24mm	12mm	SOL28M	26~27	SOL28E7A	100	SOL28E13A	1000
28	330	8.4mm	24mm	16mm	SOW28M	26~27	-	-	SOW28E13A	1000
32	300	7.5mm	32mm	16mm	SOL32M	22~25	-	-	SOL32E13A	1000
44	525	13.3mm	44mm	24mm	SOZ44M	17	-	-	SOZ44E13A	500

QUICK GUIDE BODY WIDTH					
SERIES	MILS	MM	SERIES	MILS	MM
SO	150	3.9	SOW	330~350	8.4~8.9
SOP	208	5.3	SOX	400	10.16
SOM	220	5.6	SOY	450	11.4
SOL	300	7.5	SOZ	525	13.3

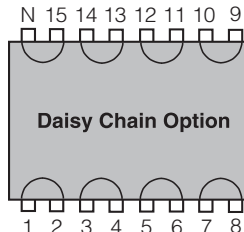

PART NUMBER	
Options	Suffix
Standard	Blank
Daisy Chain	-DE
Isolated	-ISO
Lead Free	-TIN (Sn100)

I TopLine supplies gull-wing packages with 50mil (1.27) lead pitch in a variety of pin counts and body widths. Standard plating on leads is Sn85/Pb15. For completely isolated (no internal connections) add -ISO to end of part number.

Lead Free. Add suffix to part number: -Tin = Sn100





SOJ - SMALL OUTLINE J-LEAD



SOLJ20

50 MIL PITCH (1.27MM)

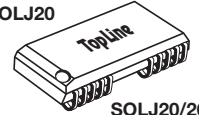

SOLJ20/26

DUMMY COMPONENT ORDERING INFORMATION

NBR LEADS	BODY WIDTH		TAPE INFO		Tube Part Number		7" (180mm) Tape & Reel Part Number		13" (330mm) Tape & Reel Part Number	
	MILS	METRIC	WIDTH	PITCH	XS1	QTY	XM1	QTY	XS1	QTY
20	300	7.5mm	24mm	12mm	SOLJ20M	33~37	-	-	SOLJ20E13A	1000
24	300	7.5mm	24mm	12mm	SOLJ24M	31	-	-	SOLJ24E13A	1000
20/26	300	7.5mm	24mm	12mm	SOLJ20/26M	27	SOLJ20/26E7A	100	SOLJ20/26E13A	1000
24/26	300	7.5mm	24mm	12mm	SOLJ24/26M	25~30	-	-	SOLJ24/26E13A	1000
28	300	7.5mm	24mm	12mm	SOLJ28M	25~27	SOLJ28E7A	100	SOLJ28E13A	1000
28	400	10.0mm	24/32mm	16mm	SOXJ28M	25~26	-	-	SOXJ28E13A	1000
32	300	7.5mm	32mm	16mm	SOLJ32M	22~23	-	-	SOLJ32E13A	1000
32	400	10.0mm	32mm	16mm	SOXJ32M	22~23	-	-	SOXJ32E13A	500~1000
40	400	10.0mm	44mm	16mm	SOXJ40M	15~18	-	-	SOXJ40E13A	500~1000
42	400	10.0mm	44mm	16mm	SOXJ42M	16~17	-	-	SOXJ42E13A	500~1000
44	400	10.0mm	44mm	16mm	SOXJ44M	17	-	-	SOXJ44E13A	500~1000

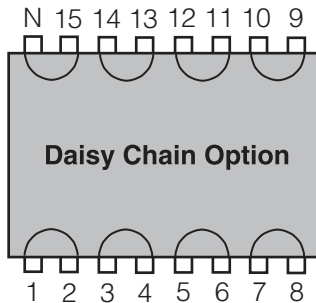

PART NUMBER	
Options	Suffix
Standard	Blank
Daisy Chain	-DE
Isolated	-ISO
Lead Free	-TIN (Sn100)

**I
N
F
O** TopLine supplies a variety of SOJ packages with 50 mil (1.27mm) lead pitch. The DRAM package uses 20 leads on. Tube quantities may vary. For completely isolated (no internal connections) add -ISO to end of part number. Solder plating on leads is Sn85/Pb15.

Lead Free Option: Sn100 add -TIN to end of part number.



FLAT PACK

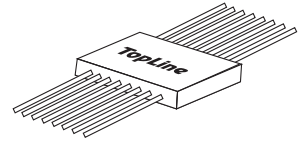

DUMMY COMPONENT ORDERING INFORMATION

NBR LEADS	CASE SIZE	LEAD SHAPE	LEAD BRAZE	XF1	PART NUMBER
50 MIL PITCH					
8	.25" SQ	FLAT	Bottom		FP8F50SQ.25B
10	.25" SQ	FLAT	Bottom		FP10C50SQ.25B
10	.25" SQ	FLAT	Side		FP10F50SQ.25S
14	.26" x .34"	FLAT	Side		FP14C50R.26x.34S
14	.26" x .34"	GULL	Side		FP14G50SQ.26S-3.2
16	.25" x .38"	GULL	Side		FP16G50R.25X.38S-S
16	.25" x .38"	FLAT	Side		FP16C50R.25x.38S
20	.27" x .50"	FLAT	Side		FP20F50R.27X.50S
24	.30" x .50"	FLAT	Side		FP24C50R.30x.50S
24	.40" x .50"	FLAT	Bottom		FP24F50R.40X.50B
24	.40" x .60"	FLAT	Bottom		FP24F50R.40X.60B
28	.40" x .72"	FLAT	Side		FP28F50R.40x.72S
28	.50" x .72"	FLAT	Side		FP28F50R.50x.72S
32	.40" x .820"	FLAT	Bottom		FP32F50R.40X.82B
36	.50" x .93"	FLAT	Bottom		FP36F50R.50X.93B
42	.64" x 1.06"	FLAT	Top		FP42F50R.64x1.06T
48	.64" x 1.31"	FLAT	Top		FP48F50R.64x1.21T
52	.64"x1.31"	FLAT	Top		FP52F50R.64x1.31T
25 MIL PITCH					
48	.40"x76"	FLAT	Bottom		FP48F25R.40x.72B
56	.40"x76"	FLAT	Bottom		FP56F25R.40x.72B

LEAD LOCATIONS

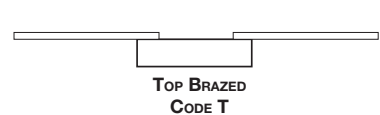
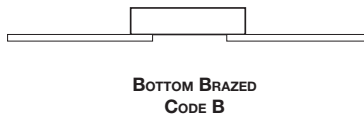

PART NUMBER



PACKAGING	CODE	LEAD PLATING	PART NBR SUFFIX
Carrier	C	Gold	Blank
Lead Frame	F	Solder Coat	-SC
		Daisy Chain	-DE
		Without Lid	-N
		ALLOY 42	-A

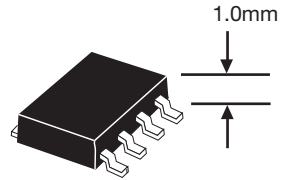

MSOP GULL WING MINIATURE SMALL OUTLINE PACKAGE

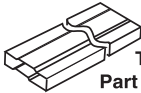

DUMMY COMPONENT ORDERING INFORMATION

NBR LEADS	BODY WIDTH		TAPE INFO		LEAD PITCH		 Tube Part Number XS1 QTY	 7" (180mm) Tape & Reel Part Number XS1 QTY		
	MILS	METRIC	WIDTH	PITCH	mils	mm				
8	118	3mm	12mm	8mm	25.6mils	0.65mm	MSOP8M	50~98	MSOP8E7A	3000
10	118	3mm	12mm	8mm	19.7mils	0.50mm	MSOP10M	50~98	MSOP10E7A	3000

Daisy Chain available
add -DE to end of part number

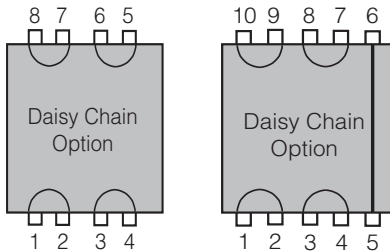

PART NUMBER	
Options	Suffix
Standard	Blank
Daisy Chain	-DE
Isolated	-ISO
Lead Free	-TIN (Sn100)

OTZ-

Solder plated leads Sn85/Pb15. For Daisy Chain add -DE to end of part number
For completely isolated (no internal connections) add -ISO to end of part number.



 Lead Free. Suffix -Tin = Sn100

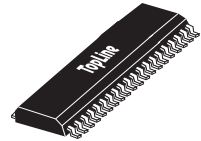

SSOP SHRINK SMALL OUTLINE PACKAGES

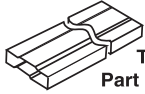

DUMMY COMPONENT ORDERING INFORMATION

BODY WIDTH	NBR LEAD		TAPE INFO		 Tube Part Number		 13" (330mm) Tape & Reel Part Number	
	LEADS	PITCH	WIDTH	PITCH	XS1	QTY	XS1	QTY
150mil (3.9mm)	16	0.636mm	12mm	8mm	QSOP16M25	99	QSOP16E13A25	1000
	20	0.636mm	16mm	8/12mm	QSOP20M25	55	QSOP20E13A25	1000
	24	0.636mm	16mm	8/12mm	QSOP24M25	55	QSOP24E13A25	1000
	28	0.636mm	16mm	8/12mm	QSOP28M25	48	QSOP28E13A25	1000
	40	0.5mm	16mm	8mm	QVSOP40M19.7	48	QVSOP40E13A19.7	1000
	48	0.4mm	16mm	8mm	QVSOP48M15.7	48	QVSOP48E13A15.7	1000
	80	0.5mm	24mm	12mm	QVSOP80M19.7	24	QVSOP80E13A19.7	1000
208 mil (5.3mm)	8		12mm	8mm	SSOP8M25	160	SSOP8E13A25	2500
	14		12/16mm	12mm	SSOP14M25	77	SSOP14E13A25	1000
	16		12/16mm	12mm	SSOP16M25	77	SSOP16E13A25	1000
	20	.65mm	16mm	12mm	SSOP20M25	66	SSOP20E13A25	1000
	24		16mm	12mm	SSOP24M25	59	SSOP24E13A25	1000
	28		16/24mm	12mm	SSOP28M25	47	SSOP28E13A25	1000
300 mil (7.5mm)	36	0.8mm	24mm	12/16mm	SSOP36M30	31	SSOP36E13A30	1000
	48	0.636mm	32mm	12/16mm	SSOP48M25	30	SSOP48E13A25	1000
	56	0.636mm	32mm	12/16mm	SSOP56M25	26	SSOP56E13A25	1000
433mil (11mm) Exposed Heat Sink	20	1.27mm	44mm	24mm	HSOP20M	30	HSOP20E13A	500
	24	1.0mm	44mm	24mm	HSOP24M40	30	HSOP24E13A40	500
	30	0.8mm	44mm	24mm	HSOP30M30	30	HSOP30E13A30	500
	36	0.65mm	44mm	24mm	HSOP36M25	30	HSOP36E13A25	500
	44	0.65mm	44mm	24mm	HSOP44M25	30	HSOP44E13A25	500

SSOP - Shrink Small Outline Packages in 0.65mm (25.7 mil) and 0.80mm (31.5 mil) lead pitch. Package height is 1.63mm for 150 mil wide body, 1.75mm for 208 mil wide body and 2.3mm high for 300 mil wide body. The QSOP package is a true 25.0 mil lead pitch (0.636mm). Standard plated leads Sn85/Pb15.

 Lead Free Option. F = NiPd. Suffix -TIN = Sn100.



TSSOP THIN SHRINK SMALL OUTLINE PACKAGE

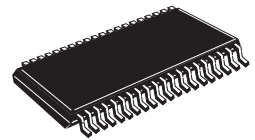

DUMMY COMPONENT ORDERING INFORMATION

BODY LENGTH	NBR LEAD		TAPE INFO		Tube Part Number	QTY	13" (330mm) Tape & Reel Part Number	QTY
	LEADS	PITCH	WIDTH	PITCH				
173 mil (4.4mm) Wide								
3.0mm	8	0.65mm	12/16mm	8mm	TSSOP8M25	100	TSSOP8E13A25	1000-3000
5.0mm	14	0.65mm	12/16mm	8mm	TSSOP14M25	96	TSSOP14E13A25	1000-3000
5.0mm	16	0.65mm	12/16mm	8mm	TSSOP16M25	90-96	TSSOP16E13A25	1000-3000
6.5mm	20	0.65mm	16mm	8/12mm	TSSOP20M25	74-76	TSSOP20E13A25	1000-3000
7.8mm	24	0.65mm	16mm	8/12mm	TSSOP24M25	62-63	TSSOP24E13A25	1000-3000
9.7mm	28	0.65mm	16mm	8/12mm	TSSOP28M25	50	TSSOP28E13A25	1000-3000
7.8mm	30	0.5mm	16mm	8/12mm	TSSOP30M19.7	62	TSSOP30E13A19.7	1000-3000
9.7mm	38	0.5mm	16mm	8/12mm	TSSOP38M19.7	49-50	TSSOP38E13A19.7	1000-3000
11.3mm	44	0.5mm	24mm	12mm	TSSOP44M19.7	42	TSSOP44E13A19.7	1000-3000
9.7mm	48	0.4mm	16mm	8/12mm	TSSOP48M15.7	50	TSSOP48E13A15.7	1000-3000
11.3mm	56	0.4mm	24mm	12mm	TSSOP56M15.7	42	TSSOP56E13A15.7	1000-3000
240 mil (6.1mm) Wide								
11.0mm	32	0.65mm	24mm	12mm	TSSOP32M25	44	TSSOP32E13A25	1000-3000
12.5mm	38	0.65mm	24mm	12mm	TSSOP38M25	39	TSSOP38E13A25	1000-3000
12.5mm	48	0.5mm	24mm	12mm	TSSOP48M19.7	39	TSSOP48E13A19.7	1000-3000
14.0mm	56	0.5mm	24mm	12mm	TSSOP56M19.7	35	TSSOP56E13A19.7	1000-3000
17.0mm	64	0.5mm	24mm	12mm	TSSOP64M19.7	28	TSSOP64E13A19.7	1000-3000

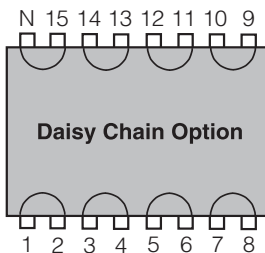

PART NUMBER	
Options	Suffix
Standard	Blank
Daisy Chain	-DE
Isolated	-ISO
Lead Free	-TIN (Sn100)

TopLine supplies TSSOP - Thin Shrink Small Outline Packages in 1.0mm height. Tape width and pitch may vary. Tube quantities may vary. Call TopLine for details. Standard plated leads Sn85/Pb15.

Lead Free. Suffix -TIN = Sn100.



TSOP - TYPE 1 THIN SMALL OUTLINE PACKAGE

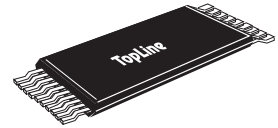

DUMMY COMPONENT ORDERING INFORMATION

LEAD		CASE SIZE INCLUDES LEADS	TAPE INFO		Tray Part Number	QTY	13" (330mm) Tape & Reel Part Number	QTY
NBR	PITCH		WIDTH	PITCH				
28	0.55mm	8 x 13.4mm	24mm	12mm	TSOP28ST21.6-T1	234	TSOP28SE13A21.6-T1	1000
32	0.5mm	8 x 20mm	32mm	12/16mm	TSOP32T19.7-T1	156	TSOP32E13A19.7-T1	1000
32	0.5mm	8 x 13.4mm	24mm	12mm	TSOP32ST19.7-T1	234	TSOP32SE13A19.7-T1	1000
40	0.5mm	10 x 14mm	24mm	16mm	TSOP40ST19.7-T1	160	TSOP40SE13A19.7-T1	1000
40	0.5mm	10 x 20mm	32mm	16mm	TSOP40T19.7-T1	120	TSOP40E13A19.7-T1	1000
48	0.5mm	12 x 20mm	32mm	16mm	TSOP48T19.7-T1	96	TSOP48E13A19.7-T1	1000
56	0.5mm	14 x 20mm	32mm	24mm	TSOP56T19.7-T1	91	TSOP56E13A19.7-T1	1000

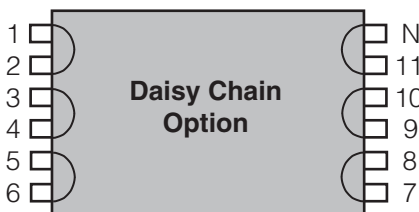

PART NUMBER	
Options	Suffix
Standard	Blank
Daisy Chain	-DE
Isolated	-ISO
Alloy42	A
Lead Free	-T (Sn100)

TopLine offers TSOP-Type 1 packages in lead counts from 28 to 56. Package thickness is 1.0mm with maximum seated height of 1.2mm. Type 1 indicates leads extending from narrow end of body. For Daisy Chain available on special order, add -DE to end of part number. For completely isolated (no internal connections) add -ISO to end of part number. TSOP contain internal die. Tin Lead (SnPb) special order.

Lead Free. Suffix -TIN = Sn100.



TSOP - TYPE 2

THIN SMALL

OUTLINE PACKAGE

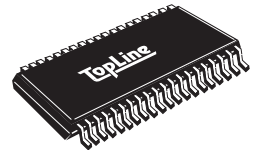

DUMMY COMPONENT ORDERING INFORMATION

LEAD		CASE SIZE EXCLUDES LEADS	TAPE INFO		Tray Part Number		13" (330mm) Tape & Reel Part Number	
NBR	PITCH		WIDTH	PITCH	XO1	QTY	XO1	QTY
32	1.27mm	10 x 21.0mm	32mm	16mm	TSOP32T50-T2	117	TSOP32E13A50-T2	500~1000
40/44	0.8mm	10 x 18.4mm	32mm	16mm	TSOP40/44T30-T2	135	TSOP40/44E13A30-T2	500~1000
44	0.8mm	10 x 18.4mm	32mm	16mm	TSOP44T30-T2	135	TSOP44E13A30-T2	500~1000
44/50	0.8mm	10 x 21mm	32mm	16mm	TSOP44/50T30-T2	117	TSOP44/50E13A30-T2	500~1000
50	0.8mm	10 x 21mm	32mm	16mm	TSOP50T30-T2	117	TSOP50E13A30-T2	500~1000
54	0.8mm	10 x 22.2mm	32mm	16mm	TSOP54T30-T2	108	TSOP54E13A30-T2	500~1000
66	0.65mm	10 x 22.2mm	32mm	16mm	TSOP66T25-T2	108	TSOP66E13A25-T2	500-1000
86	0.5mm	10 x 22.2mm	32mm	16mm	TSOP86T19.7-T2	108	TSOP86E13A19.7-T2	500-1000

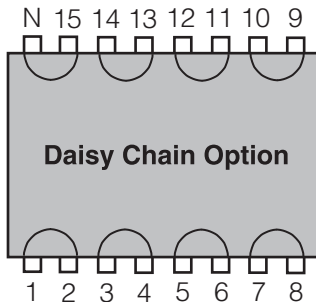

PART NUMBER	
Options	Suffix
Standard	Blank
Daisy Chain	-DE
Isolated	-ISO
Alloy42	A42
Lead Free	-TIN (Sn100)

I
O
T
Z

TSOP Type II have leads protruding from the wide side of the package. Maximum seated height is 1.2mm. Tray and tape quantities may vary. TSOP contain internal die. Solder plated leads Sn85/Pb15.

Lead Free. Suffix -TIN = Sn100.



TQFP 1.0MM THICK THIN QUAD FLAT PACK

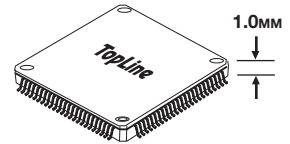

DUMMY COMPONENT ORDERING INFORMATION

NBR LEADS	LEAD PITCH		BODY SIZE A x B	TAPE INFO		Tray Part Number XQ1 QTY	13" (330mm) Tape & Reel Part Number XQ1 QTY		
	MM	MILS		WIDTH	PITCH				
32	0.5	19.7	5mm	16mm	12mm	TQFP32T19.7	360	TQFP32E13A19.7	2500
32	0.8	31.5	7mm	16mm	12mm	TQFP32T30	250	TQFP32E13A30	1000
44	0.8	31.5	10mm	24mm	16mm	TQFP44T30	160	TQFP44E13A30	1000
48	0.5	19.7	7mm	16mm	12mm	TQFP48T19.7	250	TQFP48E13A19.7	1000
52	0.65	25.6	10mm	24mm	16mm	TQFP52T25	160	TQFP52E13A25	1000
64	0.4	15.7	7mm	16mm	12mm	TQFP64T15.7	250	TQFP64E13A15.7	1000
64	0.5	19.7	10mm	24mm	24mm	TQFP64T19.7	160	TQFP64E13A19.7	1000
64	0.8	31.5	14mm	24mm	16mm	TQFP64T30	90	TQFP64E13A30	1000
80	0.4	15.7	10mm	24mm	16mm	TQFP80T15.7	160	TQFP80E13A15.7	1000
80	0.5	19.7	12mm	24mm	24mm	TQFP80T19.7	119	TQFP80E13A19.7	1000
80	0.65	25.6	14mm	24mm	24mm	TQFP80T25	90	TQFP80E13A25	1000
100	0.5	19.7	14mm	24mm	24mm	TQFP100T19.7	90	TQFP100E13A19.7	1000
120	0.4	15.7	14mm	24mm	24mm	TQFP120T15.7	90	TQFP120E13A15.7	1000
128	0.4	15.7	14mm	24mm	24mm	TQFP128T15.7	90	TQFP128E13A15.7	1000
144	0.5	19.7	20mm	44mm	24mm	TQFP144T19.7	60	TQFP144E13A19.7	1000
176	0.4	15.7	20mm	44mm	24mm	TQFP176T15.7	60	TQFP176E13A15.7	1000

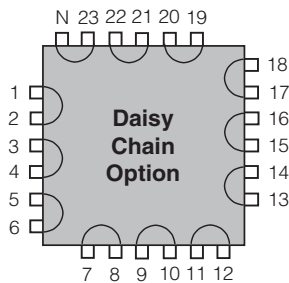
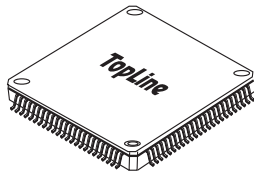

PART NUMBER	
Options	Suffix
Standard	Blank
Daisy Chain	-DE
Isolated	-ISO
Lead Free	-TIN (Sn100)

For "C" and "D" dimensions add 2.0mm to dimension "A" or "B"

Daisy Chain available on special order
Add -DE to end of part number

Thin Quad Flat Packs (TQFP) are 1.0mm thick. Lead length is 1.0mm per side. Add 2.0mm to body dimension for tip to tip of leads. For Daisy Chain "Even" add -DE to end of part number. For completely isolated (no internal connections) add -ISO to end of part number. Solder plating Sn85/Pb15.

Lead Free. Suffix TIN = Sn100.



LQFP 1.4MM THICK LOW PROFILE QUAD FLAT PACK

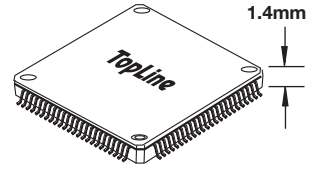

DUMMY COMPONENT ORDERING INFORMATION

NBR LEADS	LEAD PITCH		BODY SIZE A x B	TAPE INFO		Tray Part Number XQ1	QTY	13" (330mm) Tape & Reel Part Number XQ1	
	MM	MILS		WIDTH	PITCH			QTY	QTY
32	0.8	31.5	7mm	16mm	12mm	LQFP32T30	250	LQFP32E13A30	1000
44	0.8	31.5	10mm	24mm	16/24mm	LQFP44T30	160	LQFP44E13A30	1000
48	0.5	19.7	7mm	16mm	12mm	LQFP48T19.7	250	LQFP48E13A19.7	1000
52	0.65	25.6	10mm	24mm	16/24mm	LQFP52T25	160	LQFP52E13A25	1000
64	0.4	15.7	7mm	16mm	12mm	LQFP64T15.7	250	LQFP64E13A15.7	1000
64	0.5	19.7	10mm	24mm	16/24mm	LQFP64T19.7	160	LQFP64E13A19.7	1000
64	0.8	31.5	14mm	24mm	20/24mm	LQFP64T30	90	LQFP64E13A30	1000
80	0.4	15.7	10mm	24mm	16/24mm	LQFP80T15.7	160	LQFP80E13A15.7	1000
80	0.5	19.7	12mm	24mm	16/24mm	LQFP80T19.7	119	LQFP80E13A19.7	1000
80	0.65	25.6	14mm	24mm	20/24mm	LQFP80T25	90	LQFP80E13A25	1000
100	0.5	19.7	14mm	24mm	20/24mm	LQFP100T19.7	90	LQFP100E13A19.7	1000
100	0.65	25.6	14x20mm	44mm	24mm	LQFP100T25	72	LQFP100E13A25	1000
120	0.4	15.7	14mm	24mm	20/24mm	LQFP120T15.7	90	LQFP120E13A15.7	1000
128	0.4	15.7	14mm	24mm	20/24mm	LQFP128T15.7	90	LQFP128E13A15.7	1000
128	0.5	19.7	14x20mm	44mm	24mm	LQFP128T19.7	72	LQFP128E13A19.7	1000
144	0.5	19.7	20mm	44mm	24mm	LQFP144T19.7	60	LQFP144E13A19.7	1000
160	0.5	19.7	24mm	44mm	32mm	LQFP160T19.7	40	LQFP160E13A19.7	1000
176	0.4	15.7	20mm	44mm	24mm	LQFP176T15.7	60	LQFP176E13A15.7	1000
176	0.5	19.7	24mm	44mm	32mm	LQFP176T19.7	40	LQFP176E13A19.7	500
208	0.5	19.7	28mm	44mm	32mm	LQFP208T19.7	36	LQFP208E13A19.7	500
216	0.4	15.7	24mm	44mm	32mm	LQFP216T15.7	40	LQFP216E13A15.7	500
256	0.4	15.7	28mm	44mm	32mm	LQFP256T15.7	36	LQFP256E13A15.7	500

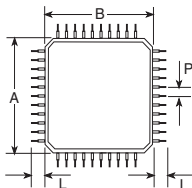

For dimension "C" or "D" add 2.0mm to dimension "A" or "B".

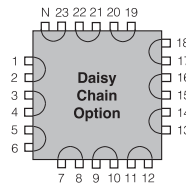

PART NUMBER	
Options	Suffix
Standard	Blank
Daisy Chain	-DE
Isolated	-ISO
Lead Free	-TIN (Sn100)

OTZ- LQFPs are slightly thicker than TQFPs. Leads are 1.0mm long. Add 2.0mm to body size for total overall dimensions. For Daisy Chain "Even," add -DE to end of part number. For completely isolated (no internal connections) add -ISO to end of part number. Standard plating Sn85/Pb15.

Lead Free. Suffix TIN = Sn100.

QFP QUAD FLAT PACK

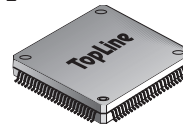

SQUARE BODY

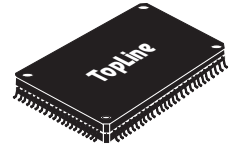

RECTANGULAR BODY

DUMMY COMPONENT ORDERING INFORMATION

NBR LEADS	2xL FOOTPRINT ADDER	LEAD PITCH		Tray Part Number XQ1	QTY	7" (180mm) Tape & Reel Part Number XM1		13" (330mm) Tape & Reel Part Number XQ1		
	MM	MILS	MM			QTY	QTY	QTY		
10MM SQUARE BODY										
44	3.2mm	31.5	0.8	QFP44T30-3.2	96	QFP44E7A30-3.2	50	QFP44E13A30-3.2	750	
44	3.9mm	31.5	0.8	QFP44T30-3.9	96	QFP44E7A30-3.9	50	QFP44E13A30-3.9	750	
52	3.2mm	25.6	0.65	QFP52T25-3.2	96	-	-	QFP52E13A25-3.2	750	
52	3.9mm	25.6	0.65	QFP52T25-3.9	96	-	-	QFP52E13A25-3.9	750	
64	3.2mm	19.7	0.5	QFP64T19.7-3.2	96	-	-	-	-	
14MM SQUARE BODY										
44	3.2mm	40	1.0	QFP44T40-3.2	84	-	-	QFP44E13A40-3.2	500	
52	3.2mm	40	1.0	QFP52T40-3.2	84	-	-	QFP52E13A40-3.2	500	
64	3.2mm	31.5	0.8	QFP64T30-3.2-2.0H	84	-	-	QFP64E13A30-3.2-2.0H	500	
64	3.2mm	31.5	0.8	QFP64T30-3.2-2.7H	84	-	-	QFP64E13A30-3.2-2.7H	500	
80	3.2mm	25.6	0.65	QFP80T25-3.2-2.0H	84	-	-	QFP80E13A25-3.2-2.0H	500	
80	3.2mm	25.6	0.65	QFP80T25-3.2-2.7H	84	-	-	QFP80E13A25-3.2-2.7H	500	
100	2.0mm	19.7	0.5	SQFP100T19.7-2.0	50	-	-	-	-	
14MM x 20MM RECTANGULAR BODY										
64	3.2mm	40	1.0	QFP64T40-3.2	60	QFP64E7A40-3.2	-	QFP64E13A40-3.2	200	
64	3.9mm	40	1.0	QFP64T40-3.9	66	QFP64E7A40-3.9	50	QFP64E13A40-3.9	200	
80	3.9mm	31.5	0.8	QFP80T30-3.9	66	QFP80E7A30-3.9	50	QFP80E13A30-3.9	200	
100	3.2mm	25.6	0.65	QFP100T25-3.2	66	QFP100E7A25-3.2	50	QFP100E13A25-3.2	200	
100	3.9mm	25.6	0.65	QFP100T25-3.9	66	QFP100E7A25-3.9	50	QFP100E13A25-3.9	200	
100	5.6mm	25.6	0.65	QFP100T25-5.6	60	-	-	-	-	
128	3.2mm	19.7	0.5	QFP128T19.7-3.2	66	-	-	-	-	

BODY SIZE	TYPICAL THICKNESS	TAPE INFO	
		WIDTH	PITCH
10mm Sq.	2.0mm	24mm	16/24mm
14mm Sq.	2.0mm	32mm	24mm
14mm Sq.	2.7mm	32mm	24mm
14 x 20mm	2.7mm	44mm	32mm
28mm Sq.	3.6mm	44mm	40mm
32mm Sq.	3.8mm	56mm	44mm
40mm Sq.	3.8mm	-	-

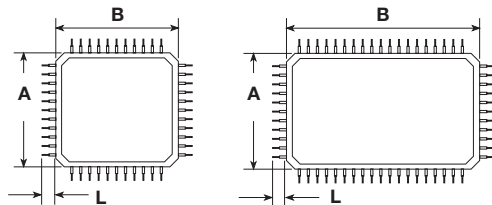

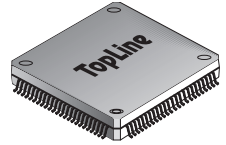

DUMMY COMPONENT ORDERING INFORMATION

NBR LEADS	2xL FOOTPRINT ADDER		LEAD PITCH		Tray Part Number XQ1	QTY	7" (180mm) Tape & Reel Part Number XM1		QTY	13" (330mm) Tape & Reel Part Number XQ1		QTY
	MM	MILS	MM	MILS								
28MM SQUARE BODY												
120	3.2mm	31.5	0.8		QFP120T30-3.2	24	-	-		QFP120E13A30-3.2	200	
120	3.9mm	31.5	0.8		QFP120T30-3.9	24	QFP120E7A30-3.9	50		QFP120E13A30-3.9	200	
128	3.2mm	31.5	0.8		QFP128T30-3.2	24	-	-		QFP128E13A30-3.2	200	
128	3.9mm	31.5	0.8		QFP128T30-3.9	24	-	-		QFP128E13A30-3.9	200	
136	3.2mm	25.6	0.65		QFP136T25-3.2	24	-	-		QFP136E13A30-3.2	200	
144	2.6mm	25.6	0.65		QFP144T25-2.6	24	-	-		QFP144E13A25-2.6	200	
144	3.2mm	25.6	0.65		QFP144T25-3.2	24	QFP144E7A25-3.2	50		QFP144E13A25-3.2	200	
144	3.9mm	25.6	0.65		QFP144T25-3.9	24	-	-		QFP144E13A25-3.9	200	
160	2.6mm	25.6	0.65		QFP160T25-2.6	24	-	-		QFP160E13A25-2.6	200	
160	3.2mm	25.6	0.65		QFP160T25-3.2	24	QFP160E7A25-3.2	50		QFP160E13A25-3.2	200	
160	3.9mm	25.6	0.65		QFP160T25-3.9	24	QFP160E7A25-3.9	50		QFP160E13A25-3.9	200	
184	2.6mm	19.7	0.5		QFP184T19.7-2.6	24	-	-		QFP184E13A19.7-2.6	200	
208	2.6mm	19.7	0.5		QFP208T19.7-2.6	24	QFP208E7A19.7-2.6	50		QFP208E13A19.7-2.6	200	
256	2.6mm	15.7	0.4		QFP256T15.7-2.6	24	QFP256E7A15.7-2.6	50		QFP256E13A15.7-2.6	200	
32MM SQUARE BODY												
240	2.6mm	19.7	0.5		QFP240T19.7-2.6	24	-	-		QFP240E13A19.7-2.6	200	
40MM SQUARE BODY												
304	2.6mm	19.7	0.5		QFP304T19.7-2.6	12	-	-		-	-	

Daisy Chain
available on special order
Add -DE to end of part number
See page 35

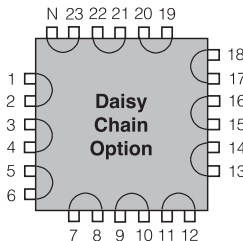

PART NUMBER	
Options	Suffix
Standard	Blank
Daisy Chain	-DE
Isolated	-ISO
Lead Free	-TIN (Sn100)

I TopLine supplies a wide assortment of Quad Flat Packs in metric packages. Add 2 x L foot print to the body size for total tip-to-tip dimension. Coplanarity guaranteed to 4 mils (0.1mm). Tray quantities may vary. Some QFP contain internal die. For completely isolated (no internal connections) add -ISO to end of part number. Standard plating Sn85/Pb15.

N Lead Free option suffix TIN = Sn100.



CERQUAD & CLCC CERAMIC QUAD FLAT PACK

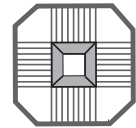

CERQUAD

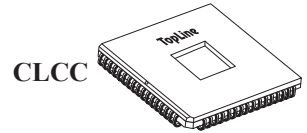

CLCC

DUMMY COMPONENT ORDERING INFORMATION

NBR LEADS	LEAD PITCH		LEAD STYLE	SQUARE BODY SIZE		Tray Part Number
	MILS	MM		INCH	METRIC (MM)	
28	50	1.27	J-lead	0.45	11.5	CLCC28J50
44	50	1.27	J-lead	0.65	16.5	CLCC44J50
52	50	1.27	J-lead	0.75	19.0	CLCC52J50
68	50	1.27	J-lead	0.95	24.1	CLCC68J50
84	50	1.27	J-lead	1.15	29.3	CLCC84J50
44	50	1.27	Flat	0.562	14.3	CERQUAD44F50
52	50	1.27	Flat	0.75	19.0	CERQUAD52F50
68	50	1.27	Flat	0.95	24.1	CERQUAD68F50
84	25	0.635	Flat	0.65	16.5	CERQUAD84F25
84	50	1.27	Flat	1.06	27.0	CERQUAD84F50
132	25	0.635	Flat	0.95	24.1	CERQUAD132F25
132	25	0.635	Flat	0.87	22.1	CERQUAD132F25
132	25	0.635	Gull-wing	0.87	22.1	CERQUAD132G25
172	25	0.635	Flat	1.15	29.3	CERQUAD172F25
196	25	0.635	Flat	1.26	32.0	CERQUAD196F25
208	19.7	0.5	Flat	1.10	28.0	CERQUAD208F19.7A
208	19.7	0.5	Gull-wing	1.10	28.0	CERQUAD208G19.7
240	19.7	0.5	Flat	1.26	32.0	CERQUAD240F19.7A
256	19.7	0.5	Flat	1.42	36.0	CERQUAD256F19.7A
304	19.7	0.5	Gull-wing	1.54	39.1	CERQUAD304G19.7
340	15	0.38	Flat	1.39	35.3	CERQUAD340F15
352	19.7	0.5	Flat	1.89	48.0	CERQUAD352F19.7A

Note: To assure an accurate quotation, please complete the order form on next page. Lids sold separately.
Leads may be solder coated or gold. Add -DE to end of part number for daisy chain.

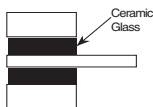

FLAT LEAD
ON LEAD FRAME

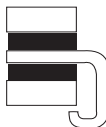

J-LEAD
CLCC

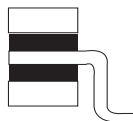



GULL-WING
WITH TIE-BAR

PART NUMBER

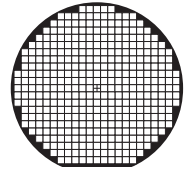
OPTIONS	PART NBR SUFFIX
With Lid	Blank
Without Lid	-N
Gold Leads	Blank
Solder Coat Leads	-SC
Completely Isolated	-ISO
Alloy 42 Body	A



DUMMY WAFER ORDERING INFORMATION

WAFER DIAMETER	WAFER TYPE	 WAFER IN JAR PART NUMBER	 WAFER IN CASSETTE PART NUMBER	 DIE TAPE & RING PART NUMBER
4-inch (100mm)	Mirrored/Polished Wafer	WM4-J	WM4-C	-
	Wafer with Etched Pattern	WE4- mm x mm - J	WE4- mm x mm -C	-
	Wafer with Sawn Mirror Die	-	-	WMD4- mm x mm -NTR
	Wafer with Sawn Etched Die	-	-	WED4- mm x mm -NTR
5-inch (125mm)	Mirrored/Polished Wafer	WM5-J	WM5-C	-
	Wafer with Etched Pattern	WE5- mm x mm - J	WE5- mm x mm -C	-
	Wafer with Sawn Mirror Die	-	-	WMD5- mm x mm -NTR
	Wafer with Sawn Etched Die	-	-	WED5- mm x mm -NTR
6-inch (150mm)	Mirrored/Polished Wafer	WM6-J	WM6-C	-
	Wafer with Etched Pattern	WE6- mm x mm - J	WE6- mm x mm -C	-
	Wafer with Sawn Mirror Die	-	-	WMD6- mm x mm -NTR
	Wafer with Sawn Etched Die	-	-	WED6- mm x mm -NTR
8-inch (200mm)	Mirrored/Polished Wafer	WM8-J	WM8-C	-
	Wafer with Etched Pattern	WE8- mm x mm - J	WE8- mm x mm -C	-
	Wafer with Sawn Mirror Die	-	-	WMD8- mm x mm -NTR
	Wafer with Sawn Etched Die	-	-	WED8- mm x mm -NTR
12-inch (300mm)	Mirrored/Polished Wafer	WM12-J	WM12-C	-
	Wafer with Etched Pattern	-	WE12-mm x mm-C	-
	Wafer with Sawn Mirror Die	-	-	WMD12- mm x mm -NTR
	Wafer with Sawn Etched Die	-	-	WED12-mm x mm -NTR
18-inch (450mm)	Glass Wafer	WM18-J	CALL	-

TYPICAL WAFER THICKNESS BEFORE BACK GRINDING

4" wafer = 525µm (20 mils)
 5" wafer = 625µm (24 mils)
 6" wafer = 680µm (27 mils)
 8" wafer = 725µm (29 mils)
 12" wafer = 775µm (31 mils)
 18" wafer = 925µm (36 mil)

OPTIONS

Back Grinding: Add suffix -BG after wafer size in part number
 Blue Nitto Tape = NT suffix
 Blue Nitto Tape & Ring = NTR suffix
 Ultra Violet Tape & Ring = UVR suffix
 Die in 2" Waffle Pack: Add -WP2 to part number
 Etch Die: ED (sawn)
 Mirror Die = MD (sawn)



DUMMY COMPONENT ORDERING INFORMATION

NBR BUMPS	PITCH	BUMP INFORMATION			DIE SIZE METRIC	NOTES	DIE PER BUMPED 5" WAFER QTY	 WAFFLE Tray Part Number	QTY
		HIGH	Ø DIA	MATERIAL					
48	457µm	140	178µm	Eutectic	6.3mm SQ	PB18	236	FC48D6.3E457	25
88	204µm	107	102µm	Eutectic	5.08mm SQ	PB08	340	FC88G5.08E204	36
112	152µm	85	88µm	Eutectic	5.08mm SQ	PB06	340	FC112K5.08E152	36
317	254µm	119	102µm	Eutectic	5.08mm SQ	FA10	340	FC317G5.08E254	36
1268	254µm	119	102µm	Eutectic	10.2mm SQ	FA10	81-85	FC1268G10E254	49
2853	254µm	119	102µm	Eutectic	15.0mm SQ	FA10	28	FC2853G15E254	25
5072	254µm	119	102µm	Eutectic	20.0mm SQ	FA10	18	FC5072G20E254	9

PART NUMBERING SYSTEM

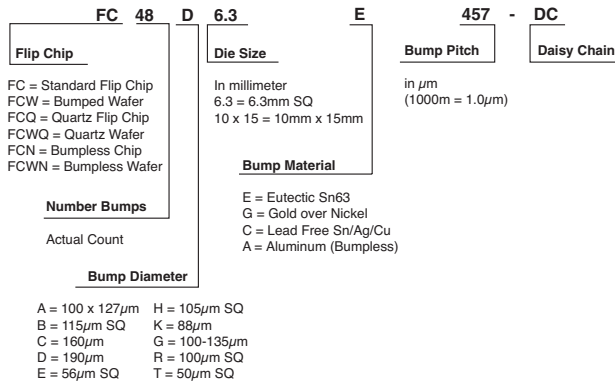

I N F O Eutectic 63/37 SnPb allows repeatable bump collapse of 25-40µm for a typical 125µm tall bump. Flip Chips are available with daisy chain (-DC). For bumped wafers, change prefix of part number to FCW. For bumpless flip chip for wire bonding, change suffix to FCN.

Lead Free available, change "E" to "C" in part number for Sn96.8/Ag2.6/Cu0.6 -SAC266 - Lead Free Eutectic Bumps.

FLIP CHIP DAISY CHAIN

(BUMP VIEW)

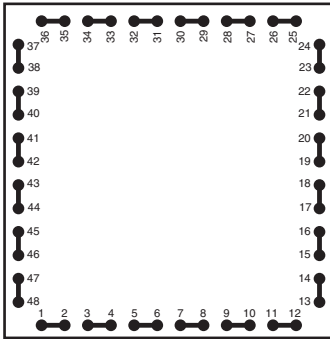

FC48 (PB18 - 250x250)

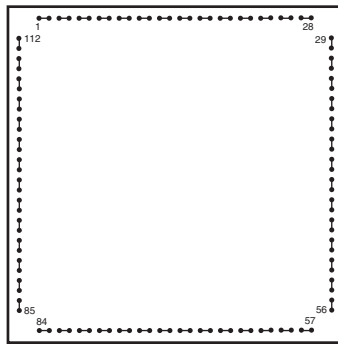

FC112 (PB06 - 200x200)

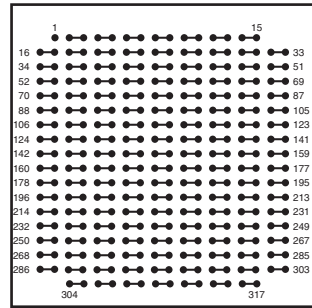

FC317 (FA10-200x200)

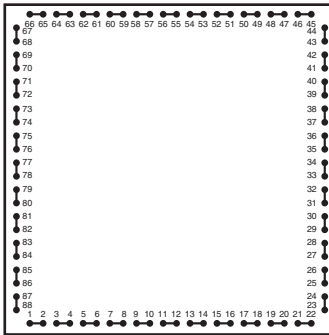

FC88 (PB08 - 200x200)

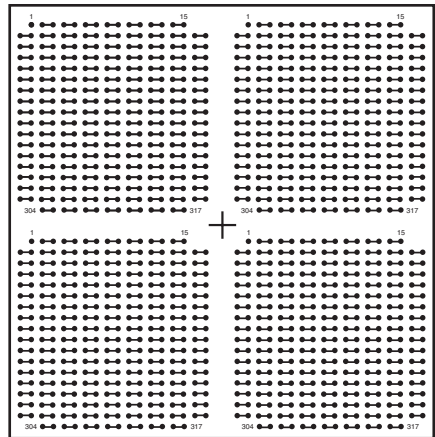

FC1268 (FA10 - 400x400)

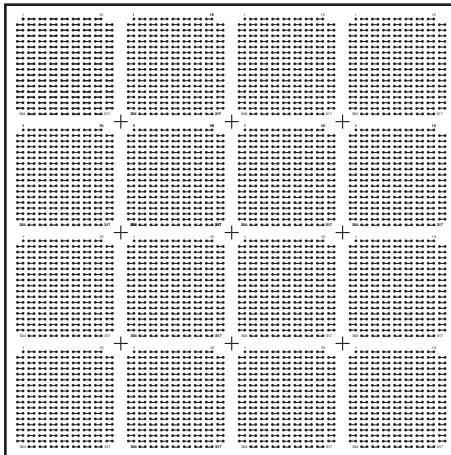

FC5072 (FA10 - 800x800)

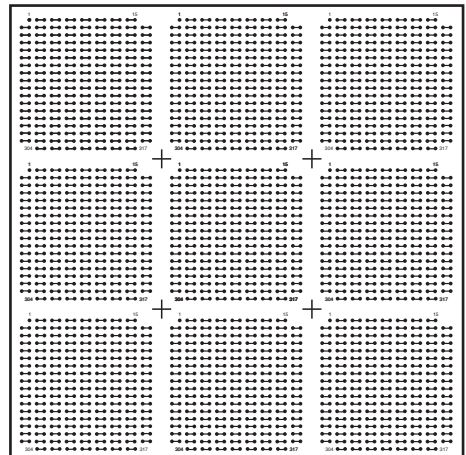

FC2853 (FA10 - 600x600)

WLP - CSP WAFFER LEVEL PRODUCT 0.3MM PITCH

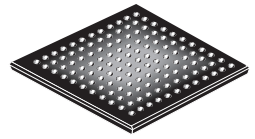

DUMMY COMPONENT ORDERING INFORMATION

FIG	NBR BALLS	BODY SIZE	BALL ALIGNMENT	BALL MATRIX	SUBSTRATE	XJ1	4" Wafler Part Number	QTY
-	4	0.6mm	Full	2x2	Si		WLP4T.3C-DC022D	CALL
-	16	1.2mm	Full	4x4	Si		WLP16T.3C-DC048D	CALL
-	36	1.8mm	Full	6x6	Si		WLP36T.3C-DC067D	CALL
-	64	2.4mm	Full	8x8	Si		WLP64T.3C-DC088D	CALL
1	100	3.0mm	Full	10x10	Si		WLP100T.3C-DC108D	256
2	144	3.6mm	Ful	12x12	Si		WLP144T.3C-DC127D	256
3	196	4.2mm	Full	14x14	Si		WLP196T.3C-DC148D	196
4	256	4.8mm	Full	16x16	Si		WLP256T.3C-DC168D	144
5	264	6.0mm	6-Row	17x17	Si		WLP264T.3C-DC173D	121
6	400	6.0mm	Full	26x26	Si		WLP400T.3C-DC208D	121
7	676	7.8mm	Full	26x26	Si		WLP676T.3C-DC260D	64
8	900	9.0mm	Full	30x30	Si		WLP900T.3C-DC307D	49
-	1600	12mm	Full	40x40	Si		WLP1600T.3C-DC407D	36

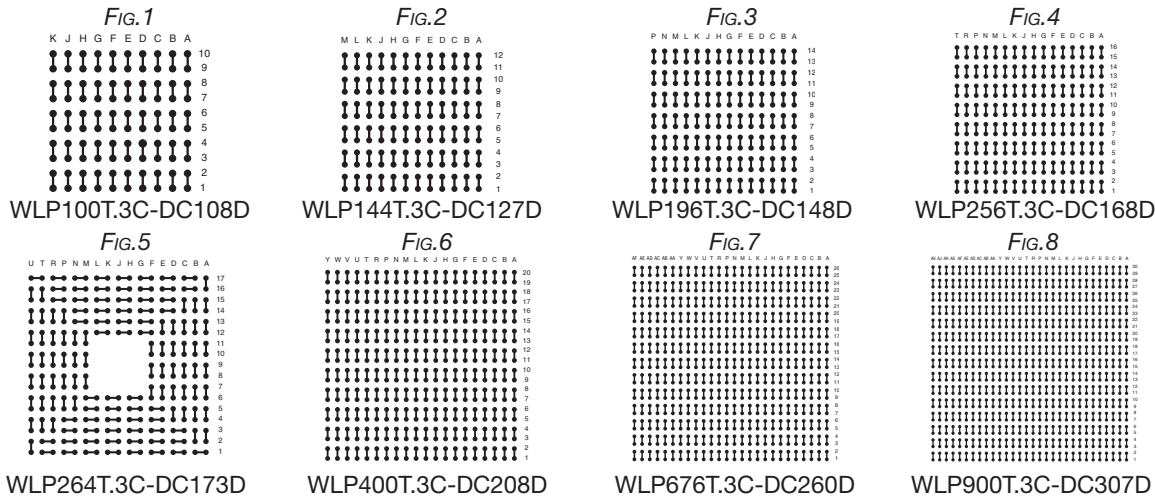

INFO WLP - Wafer Level CSP. Total package height 0.57mm. Ball diameter is 0.20mm. Silicon die with copper pillar design. Additional sizes are available. Tape & Reel change "T" to "E" Diced Wafer Tape on Ring = NTR

0.57mm

0.3mm

0.2mm

RoHS - Lead Free - All items Pb-Free RoHS with SnAgCu balls.

WLP - CSP WAFFER LEVEL PRODUCT 0.4MM PITCH

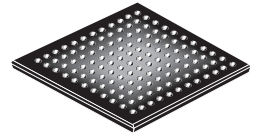

DUMMY COMPONENT ORDERING INFORMATION

FIG	NBR BALLS	BODY SIZE	BALL ALIGNMENT	BALL MATRIX	SUBSTRATE	XJ1	4" Wafler Part Number	QTY
-	4	0.8mm	Full	2x2	Si		WLP4T.4C-DC022D	CALL
-	16	1.6mm	Full	4x4	Si		WLP16T.4C-DC048D	CALL
-	36	2.4mm	Full	6x6	Si		WLP36T.4C-DC067D	CALL
-	64	3.2mm	Full	8x8	Si		WLP64T.4C-DC088D	256
1	100	4.0mm	Full	10x10	Si		WLP100T.4C-DC108D	196
2	144	6.0mm	4-Row	13x13	Si		WLP144T.4C-DC133D	144
3	196	5.6mm	Full	14x14	Si		WLP196T.4C-DC148D	121
4	256	6.4mm	Full	16x16	Si		WLP256T.4C-DC168D	81
5	400	8.0mm	Full	20x20	Si		WLP400T.4C-DC208D	64
6	676	10.4mm	Full	26x26	Si		WLP676T.4C-DC260D	49
7	900	12mm	Full	30x30	Si		WLP900T.4C-DC307D	36

Fig.1

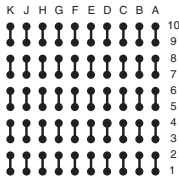

WLP100T.4C-DC108D

Fig.2



WLP144T.4C-DC133

Fig.3

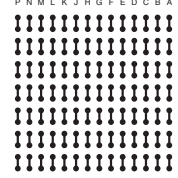

WLP196T.4C-DC148D

Fig.4

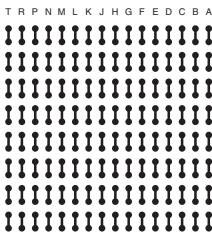

WLP256T.4C-DC168D

Fig.5

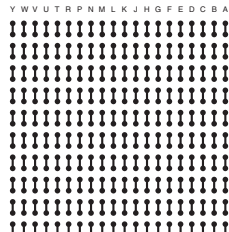

WLP400T.4C-DC208D

Fig.6

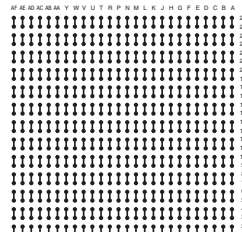

WLP676T.4C-DC260D

Fig.7

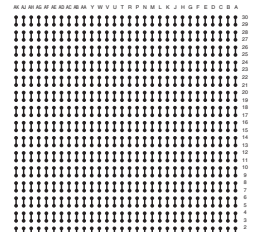

WLP900T.4C-DC307D

INFO

WLP - Wafer Level CSP. Total package height 0.61mm. Ball diameter is 0.25mm.

Silicon die with copper pillar design. Additional sizes are available.

Tape & Reel change "T" to "E" Diced Wafer Tape on Ring = NTR

- Lead Free - All items Pb-Free RoHS with SnAgCu balls.

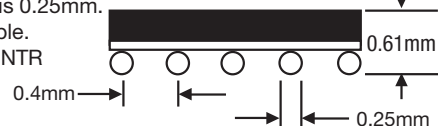



BGA - CSP BALL GRID ARRAY 0.4MM PITCH

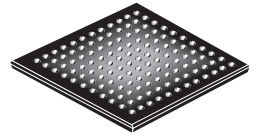

DUMMY COMPONENT ORDERING INFORMATION



Tray
Part Number

FIG	NBR BALLS	BODY SIZE	BALL ALIGNMENT	BALL MATRIX	SUBSTRATE	XJ1	QTY
1	97	5mm	Full	10x10	BT	CSP97T.4C-DC107	624
2	360	10mm	5-Row	23x23	BT	BGA360T.4C-DC235	250
3	400	10mm	Full	20x20	BT	BGA400T.4-DC209	240/250
4	625	12mm	Full	25x25	BT	BGA625T.4-DC259	189
5	900	15mm	Full	30x30	BT	BGA900T.4-DC309	126
6	1600	17mm	Full	40x40	BT	BGA1600T.4-DC409	90
7	2025	21mm	Full	45x45	BT	LBGA2025T.4-DC459	60

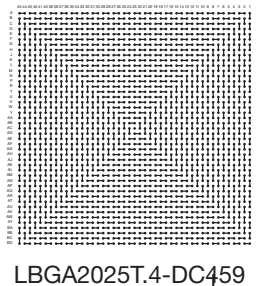
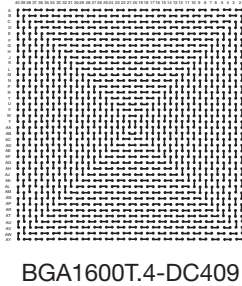
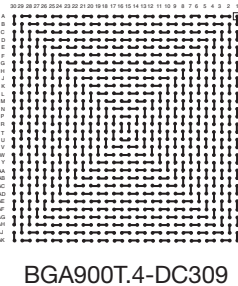
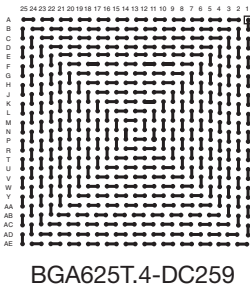
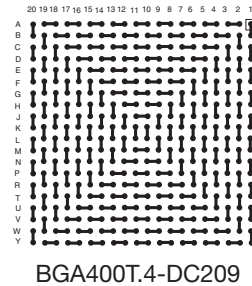
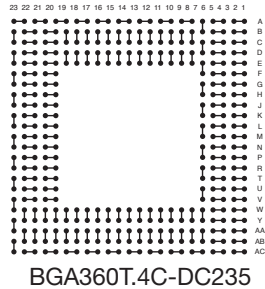
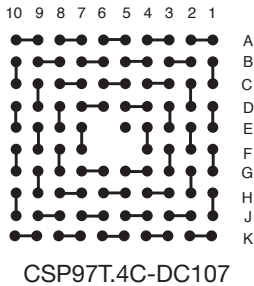

INFO

BGA - FR4 and BT Substrate. Ball diameter is 0.25mm.
For Internal Die, add suffix -D to end of part number
Depopulated "perimeter" rows are available.



- Lead free option: Add "C" after pitch in part number for SnAgCu balls.

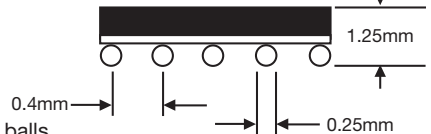

WLP - CSP WAFFER LEVEL PRODUCT 0.5MM PITCH

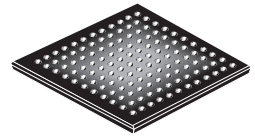

DUMMY COMPONENT ORDERING INFORMATION

FIG	NBR BALLS	BODY SIZE	BALL ALIGNMENT	BALL MATRIX	SUBSTRATE	XJ1	4" Wafler Part Number	QTY
-	4	1.0mm	Full	2x2	Si		WLP4T.5C-DC022D	CALL
-	16	2.0mm	Full	4x4	Si		WLP16T.5C-DC048D	CALL
-	36	3.0mm	Ful	6x6	Si		WLP36T.5C-DC067D	256
1	64	4.0mm	Full	8x8	Si		WLP64T.5C-DC088D	196
2	100	5.0mm	Full	10x10	Si		WLP100T.5C-DC108D	144
3	144	6.0mm	Full	12x12	Si		WLP144T.5C-DC127D	121
4	196	7.0mm	Full	14x14	Si		WLP196T.5C-DC148D	81
5	256	8.0mm	Full	16x16	Si		WLP256T.5C-DC168D	64
6	400	10mm	Full	20x20	Si		WLP400T.5C-DC208D	49
7	676	13mm	Full	26x26	Si		WLP676T.5C-DC260D	36
8	900	15mm	Full	30x30	Si		WLP900T.5C-DC307D	25

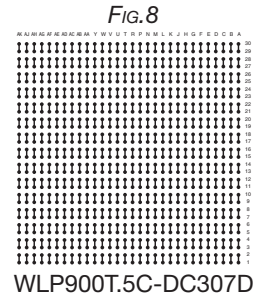
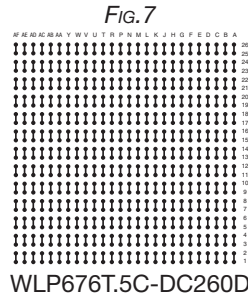
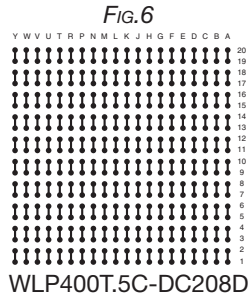
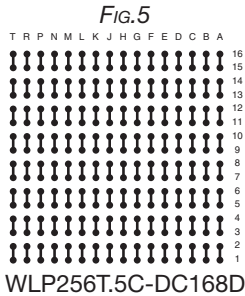
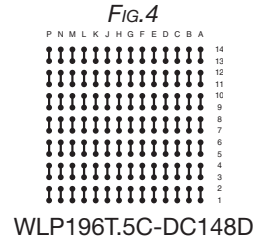
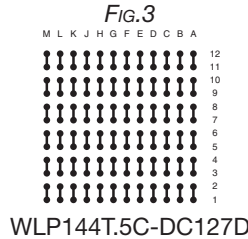
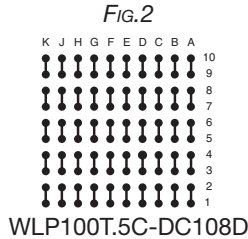
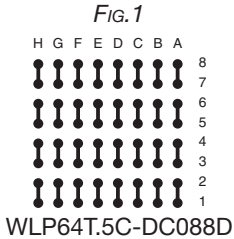

INFO

WLP - Wafer Level CSP. Total package height 0.64mm. Ball diameter is 0.3mm.
Silicon die with copper pillar design. Additional sizes are available.
Tape & Reel change "T" to "E" Diced Wafer Tape on Ring = NTR

- Lead Free - All items Pb-Free RoHS with SnAgCu balls.



CSP BALL GRID ARRAY 0.5MM PITCH

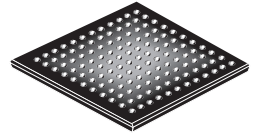

DUMMY COMPONENT ORDERING INFORMATION

FIG	NBR BALLS	BODY SIZE	BALL ALIGNMENT	HEIGHT	BALL MATRIX	SUBSTRATE	XJ1  Tray Part Number	QTY
1	6	1.5 x 1.0mm	Full	0.65mm	3 x 2	Si	CSP6E7A.5-DC023	Reel
2	40	5mm	2-Row	1.24mm	8 x 8	BT	CSP40T.5-DC082	624
3	56	6mm	2-Row	1.24mm	10 x 10	BT	CSP56T.5-DC102	608
4	84	6mm	3-Row	1.1mm	10 x 10	BT	CSP84T.5-DC104	608
5	84	7mm	3-Row	1.1mm	12 x 12	BT	CSP84T.5-DC123	476
6	96	8mm	2-Row	1.24mm	14 x 14	Pi	fBGA96T.5-DC144	360
7	132	8mm	3-Row	1.1mm	14 x 14	BT	CSP132T.5-DC145	360
8	228	12mm	3-Row	1.1mm	22 x 22	BT	LBGA228T.5-DC222	189
9	288	12mm	4-Row	1.1mm	22 x 22	BT	LBGA288T.5-DC221	189
10	484	12mm	Full	1.1mm	22 x 22	BT	LBGA484T.5-DC229	189
11	2025	25mm	Full	1.8mm	45 x 45	BT	LBGA2025T.5-DC459	44
-	625	15mm	Full	1.3mm	25x25	BT	BGA625T.5-DC259	126
-	676	15mm	Full	1.3mm	26x26	BT	BGA676T.5-DC269	126
-	900	17mm	Full	1.3mm	30x30	BT	BGA900T.5-DC309	90
-	1600	25mm	Full	1.3mm	40x40	BT	BGA1600T.5-DC409	60

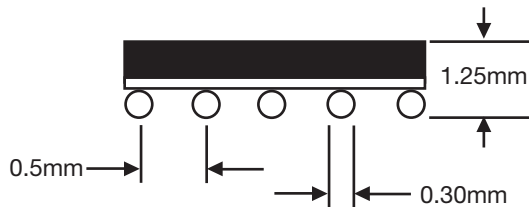

CSP - BT substrate. Total package height 1.25mm. Ball diameter is 0.3mm.
For Internal Die, add suffix -D to end of part number



- Lead free option: Add "C" after pitch in part number for SnAgCu balls.

CSP BALL GRID ARRAY 0.5MM PITCH

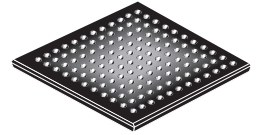

BALL VIEW

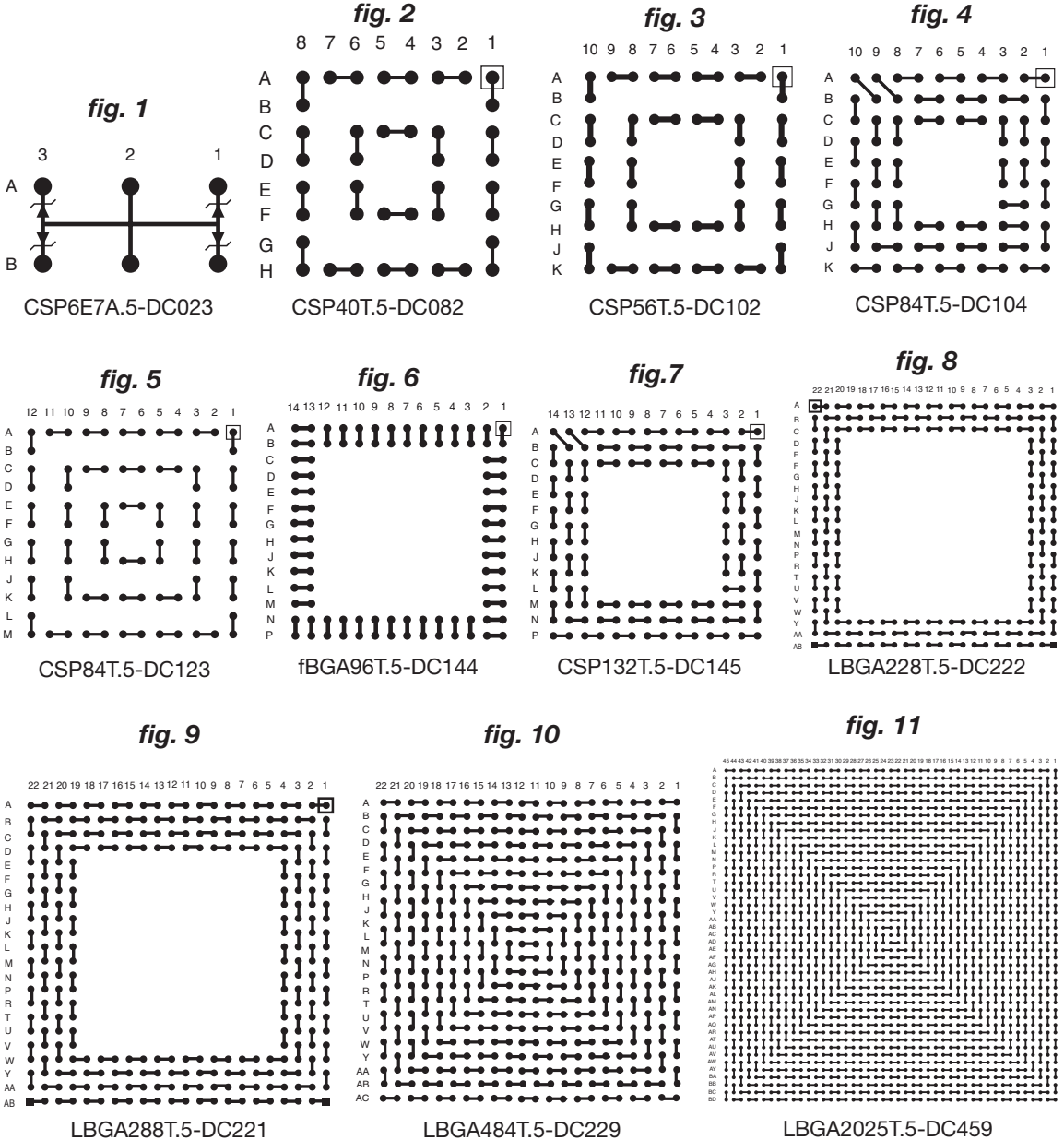



BGA & CSP BALL GRID ARRAY 0.65~0.8MM PITCH

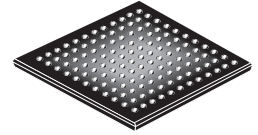

DUMMY COMPONENT ORDERING INFORMATION

FIG	NBR BALLS	BODY SIZE	BALL PATTERN	PITCH	BALL MATRIX	SUBSTRATE	Tray Part Number XJ1	QTY
1A	46	6 x 7mm	Full	0.75mm	6 x 8	BT	BGA46T.75-DC24	160
1C	48	6 x 7mm	Full	0.75mm	6 x 8	BT	BGA48T.75-6x8	160
2	36	6mm	Full	0.8mm	6 x 6	BT	BGA36T.8-DC069	608
1B	48	8 x 9mm	Full		6 x 8	FR4	LBGA48T.8-DC689	297
3	49	7mm	Full		7 x 7	BT	BGA49T.8-DC077	476
4	64	8mm	Full		8 x 8	BT	BGA64T.8-DC089	360
5	81	8mm	Full		9 x 9	BT	BGA81T.8-DC099	360
6	100	10mm	Full		10 x 10	BT	BGA100T.8-DC109	250
7	112	10mm	4-Row		11 x 11	FR4	LBGA112T.8-DC114	184
8	144	12mm	Full		12 x 12	FR4	LBGA144T.8-DC128	189
9	144	12mm	4-Row		13 x 13	FR4	LBGA144T.8-DC134	168/198
10	208	15mm	4-Row		17 x 17	BT	BGA208T.8-DC170	126
11	280	17mm	5-Row		19 x 19	FR4	LBGA280T.8-DC195	90
12	532	23mm	7-Row		26 x 26	FR4	LBGA532T.8-DC266	60
13	676	23mm	Full		26 x 26	BT	BGA676T.8-DC269	60
14	2025	40mm	Full		45 x 45	BT	LBGA2025T.8-DC459D	21
-	336	15mm	6-Row	0.65mm	20x20	FR4	BGA336T.65-DC203D	126
15	2025	32.5mm	Full	0.65mm	45 x 45	BT	LBGA2025T.65DC459D	24

fig. 1A

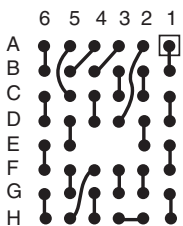

BGA46T.75-DC24

fig. 1C

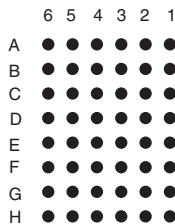

BGA48T.75-6x8

Ball View

fig. 1B

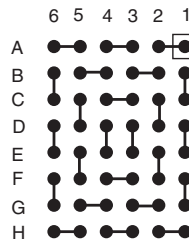

LBGA48T.8-DC689

fig. 2

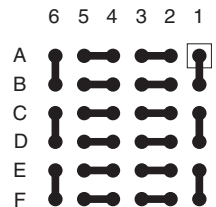

BGA36T.8-DC069

INFO

BGA - Near CSP dimensions on rigid BT substrate with molding compound.

Eutectic Sn63 solder balls 0.46mm diameter. (0.75mm Pitch is 0.3mm ball diameter)

LBGA -FR4 features near CSP dimensions with unencapsulated body.

Eutectic Sn63 solder balls 0.46mm diameter.



-Lead free option: Add "C" after pitch in part number for SnAgCu balls.



BGA & CSP BALL GRID ARRAY 0.65~0.8MM PITCH

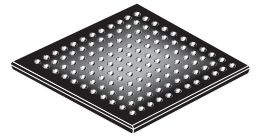

BALL VIEW

fig. 3

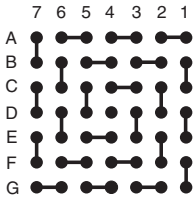

BGA49T.8-DC077

fig. 4

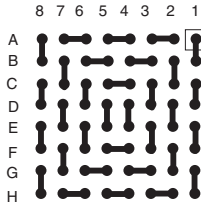

LBGA64T.8-DC089

fig. 5

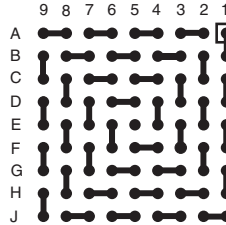

BGA81T.8-DC099

fig. 6

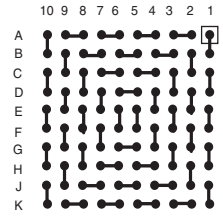

BGA100T.8-DC109

fig. 7

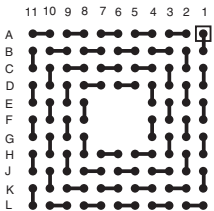

LBGA112T.8-DC114

fig. 8

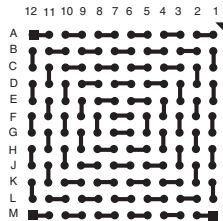

LBGA144T.8-DC128

fig. 9

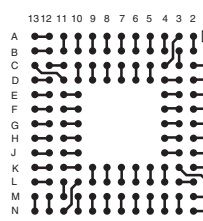

LBGA144T.8-DC134

fig. 10

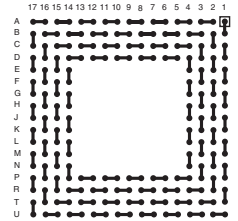

LBGA208T.8-DC170

fig. 14~15

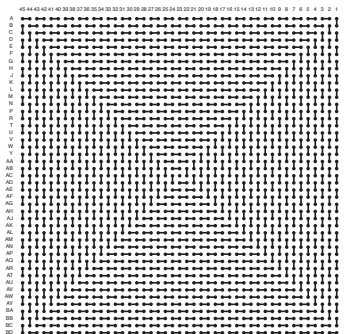

LBGA2025T.8-DC459
LBGA2025T.65-DC459

fig. 11

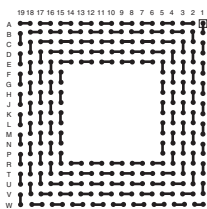

LBGA280T.8-DC195

fig. 12

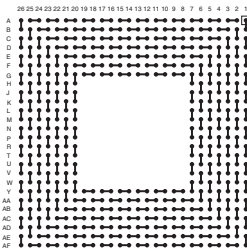

LBGA532T.8-DC266

fig. 13

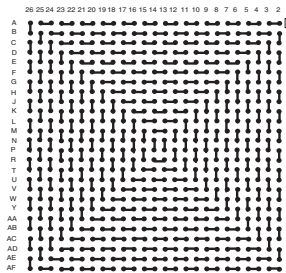

LBGA676T.8-DC269

BGA PLASTIC BALL GRID ARRAY 1.0MM PITCH

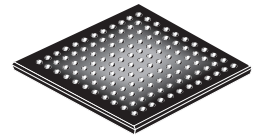

DUMMY COMPONENT ORDERING INFORMATION

FIG	NBR BALLS	BODY SIZE	BALL PATTERN	CENTER BALL	BALL MATRIX	Tray Part Number		QTY
						STANDARD	UNENCAPSULATED	
1	81	10mm	Full Array	NA	9 x 9	BGA81T1.0-ISO	-	250
2	100	11mm	Full Array	NA	10 x 10	BGA100T1.0	-	176
3	144	13mm	Full Array	NA	12 x 12	BGA144T1.0	LBGA144T1.0-DC128	160/168
4	160	15mm	4-Row	NA	14 x 14	BGA160T1.0-DC147A	-	126
5	192	17mm	4-Row	NA	16 x 16	BGA192T1.0-DC160A	-	90
6	196	15mm	Full Array	NA	14 x 14	BGA196T1.0-DC149A	-	126
7	208	17mm	4-Row	4 x 4	16 x 16	BGA208T1.0-DC164A	-	90
8	256	17mm	Full Array	NA	16 x 16	BGA256T1.0-DC169A	-	90
9	288	23mm	4-Row	NA	22 x 22	BGA288T1.0-DC221	-	60
10	324	23mm	4-Row	6 x 6	22 x 22	BGA324T1.0-DC224	-	60
11	388	27mm	4-Row	6 x 6	26 x 26	BGA388T1.0-DC264	-	40
12	400	21mm	Full Array	NA	20 x 20	-	LBGA400T1.0-DC209	60
13	484	23mm	Full Array	NA	22 x 22	-	LBGA484T1.0-DC229A	60
14	672	27mm	Full Array	NA	26 x 26	-	LBGA672T1.0-DC268	40
15	676	27mm	Full Array	NA	26 x 26	BGA676T1.0-DC269	-	40
16	900	31mm	Full Array	NA	30 x 30	-	LBGA900T1.0-DC309	27
17	1156	35mm	Full Array	NA	34 x 34	-	LBGA1156T1.0-DC349	24
18	1600	42.5mm	Full Array	NA	40 x 40	-	LBGA1600T1.0-DC409	12
19	1936	45mm	Full Array	NA	44 x 44	-	LBGA1936T1.0-DC449	12
-	10,000	115mm	Full Array	NA	100 x 100	-	LBGA10000T1.0-BUS	4

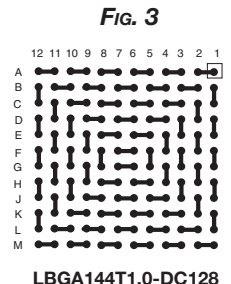
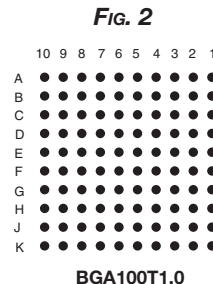
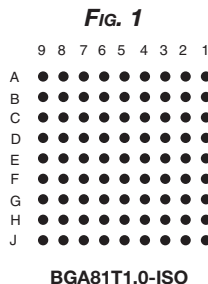
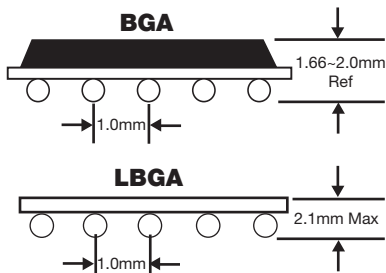

I N F O BGA - Standard BGA plastic packages should be baked at 125°C for 24 hours prior to assembly to prevent delamination and the “popcorn” phenomena during the assembly process. Solder balls are eutectic Sn63 SnPb 25mil (0.63mm)

LBGA- Unencapsulated profile laminate Ball Grid Arrays offer the lowest cost when placement practice is the primary concern. Includes daisy chain laminate substrate with 25mil (0.63mm) Sn63.

☉ - Lead Free Option: Add “C” after pitch in part number for SnAgCu balls.

BGA PLASTIC BALL GRID ARRAY 1.0MM PITCH BALL VIEW

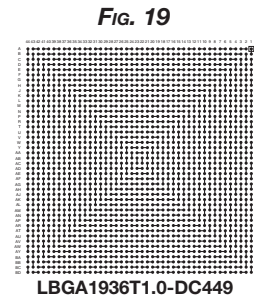
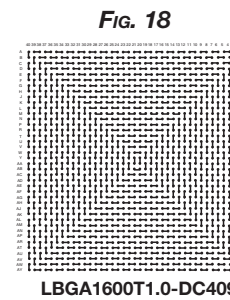
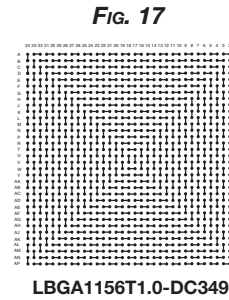
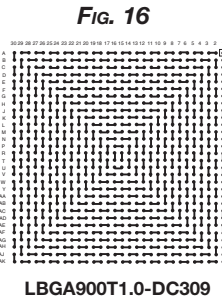
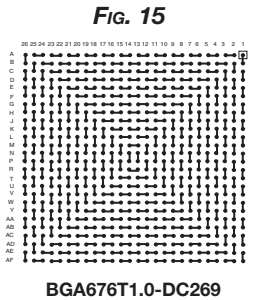
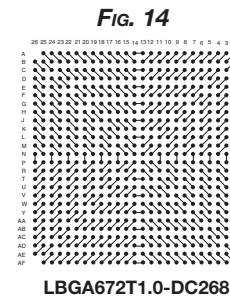
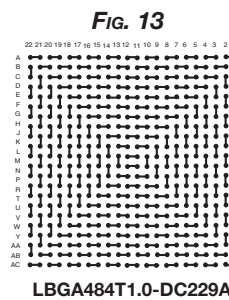
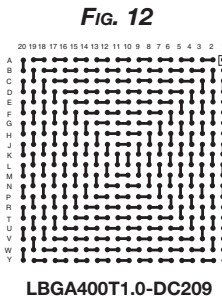
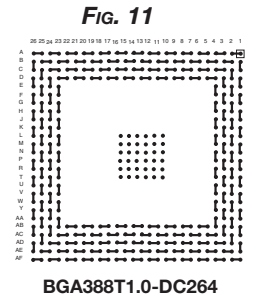
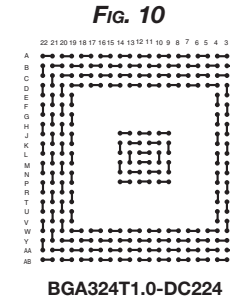
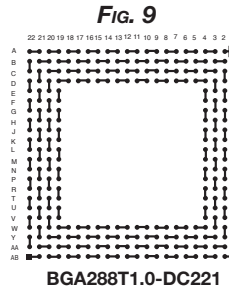
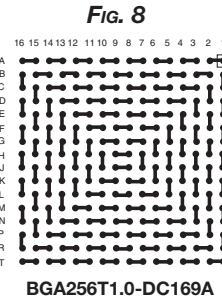
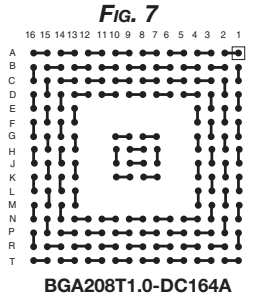
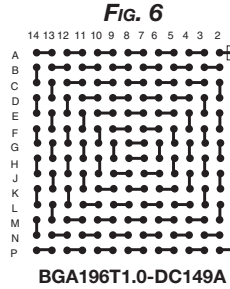
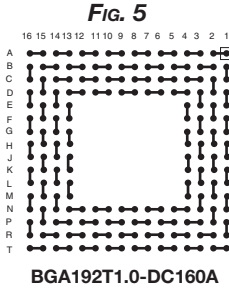
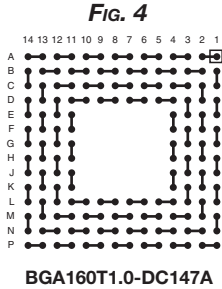
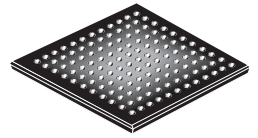



BGA

PLASTIC BALL GRID ARRAY

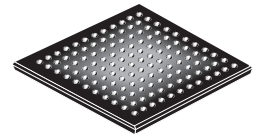
1.27MM PITCH



DUMMY COMPONENT ORDERING INFORMATION

FIG	NBR BALLS	BODY SIZE	BALL PATTERN	CENTER BALL	BALL MATRIX	 Tray Part Number STANDARD	 Tray Part Number UNENCAPSULATED	QTY
						XJ1		
1	208	23mm	4-Row	-0-	17 x 17	BGA208T1.27-DC170	-	60
2	217	23mm	4-Row	3 x 3	17 x 17	BGA217T1.27-DC172	-	60
3	256	27mm	4-Row	-0-	20 x 20	BGA256T1.27-DC200	-	40
4	256	21mm	Full	-0-	16 x 16	-	LBGA256T1.27-DC61	60
5	272	27mm	4-Row	4 x 4	20 x 20	BGA272T1.27-DC202	-	40
6	352	35mm	4-Row	-0-	26 x 26	BGA352T1.27-DC70	-	24
7	357	25mm	Full	NA	19 x 19	-	LBGA357T1.27-DC73	24
8	388	35mm	4-Row	6 x 6	26 x 26	BGA388T1.27-DC72	-	24
9	1225	45mm	Full	-0-	35 x 35	-	LBGA1225T1.27-DC359	12

SIDE VIEW

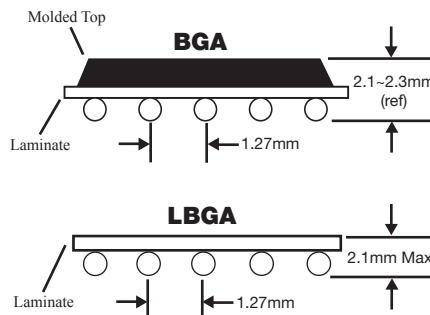

OTZ BGA - Standard BGA plastic packages should be baked at 125°C for 24 hours prior to assembly to prevent delamination and the “popcorn” phenomena during the assembly process. Solder balls are eutectic Sn63/Pb37 30mil (0.75mm)

LBGA - Laminate Ball Grid Arrays offer the lowest cost when placement practice is the primary concern. Includes daisy chain laminate with 30mil (0.75mm) Sn63/Pb37 balls for soldering at 210°C.

 - Lead Free available. SnAgCu = Add “C” after pitch in part number.



BGA PLASTIC BALL GRID ARRAY 1.27MM PITCH

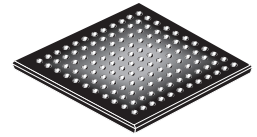

BALL VIEW

FIG. 1

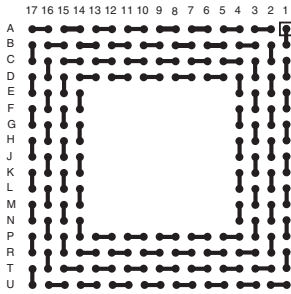

BGA208T1.27-DC170

FIG. 2

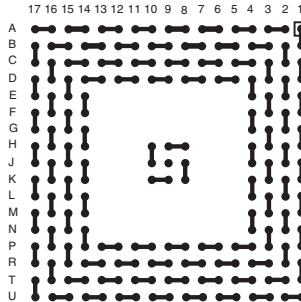

BGA217T1.27-DC172

FIG. 3

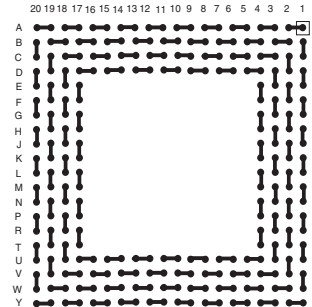

BGA256T1.27-DC200

FIG. 4

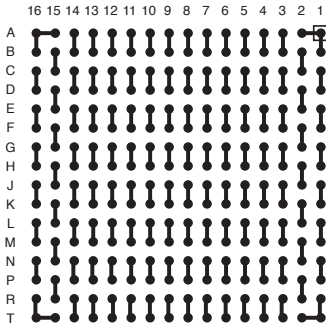

LPGA256T1.27-DC61

FIG. 5

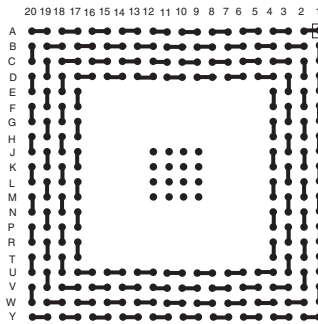

BGA272T1.27-DC202

FIG. 6

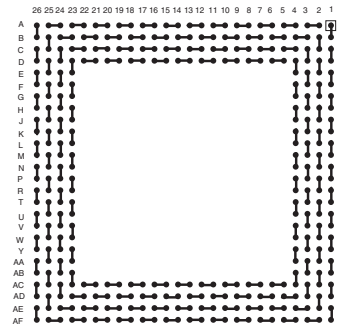

BGA352T1.27-DC70

FIG. 7

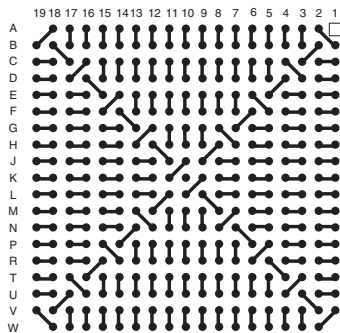

LPGA357T1.27-DC73

FIG. 8

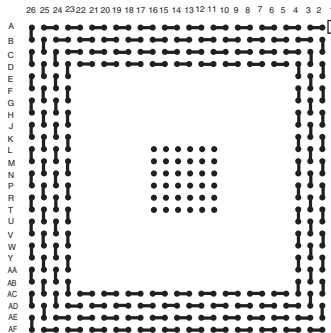

BGA388T1.27-DC72

FIG. 9

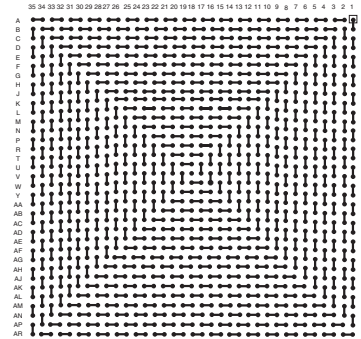

LPGA1225T1.27-DC359

CBGA CERAMIC BALL GRID ARRAY 1.27MM PITCH

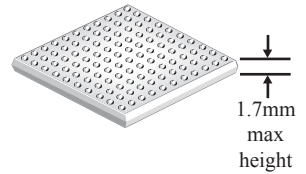

DUMMY COMPONENT ORDERING INFORMATION

FIG	NBR BALLS	BODY SIZE	BALL PATTERN	BALL MATRIX	Tray Part Number LOW TEMP 210°C	Tray Part Number HIGH TEMP 320°C	QTY
					XJ1 62/36/2 SnPbAg	XJ1 10/90 SnPb	
1	121	15mm	Full Grid	11 x 11	CBGA121T1.27L-DC5	CBGA121T1.27-DC5	126
2	196	18.5mm	Full Grid	14 x 14	CBGA196T1.27L-DC11	CBGA196T1.27-DC11	84
3	256	21mm	Full Grid	16 x 16	CBGA256T1.27L-DC61	CBGA256T1.27-DC61	60
4	304	21 x 25mm	Full Grid	16 x 19	CBGA304T1.27L-DC63	CBGA304T1.27-DC63	55
5	361	25mm	Full Grid	19 x 19	CBGA361T1.27L-DC71	CBGA361T1.27-DC71	44
6	400	27mm	Full Grid	20 x 20	CBGA400T1.27L-DC21	CBGA400T1.27-DC21	40
7	625	32.5mm	Full Grid	25 x 25	-	CBGA625T1.27-DC81	24
8	1089	42.5mm	Full Grid	33 x 33	-	CBGA1089T1.27-DC339	12

FIG. 1

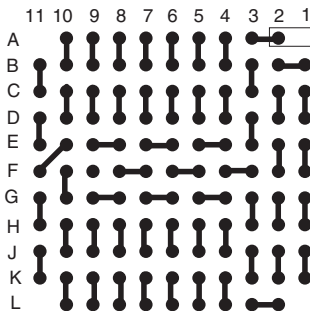

**CBGA121T1.27-DC5
(BALL VIEW)**

FIG. 2

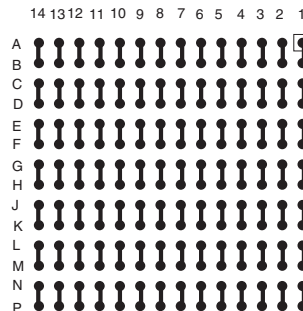

**CBGA196T1.27-DC11
(BALL VIEW)**

Ceramic Ball Grid Arrays are not sensitive to moisture and do not require baking prior to assembly. Ball diameter is 30 mils (0.75mm). Standard ball material is Sn10/Pb90 for high temperature soldering at 320°C to ceramic substrate. For low temperature soldering at 210°C to laminate substrate, specify Sn62/Pb36/Ag2 solder balls by adding -L to part number. Caution advised CTE mismatch > 25mm.

Lead free available with SnAgCu balls. Add "C" after pitch in part number

CBGA - CERAMIC BALL GRID ARRAY - 1.27MM PITCH

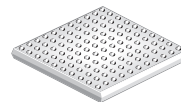
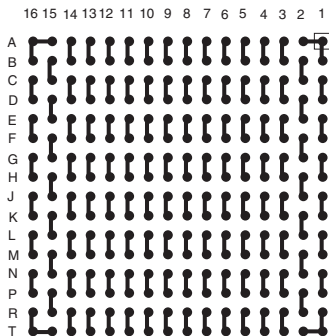
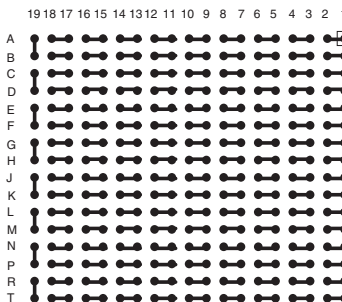

Fig. 3 (BALL VIEW)



CBGA256T1.27-DC61

Fig. 4



CBGA304T1.27-DC63

Fig. 5

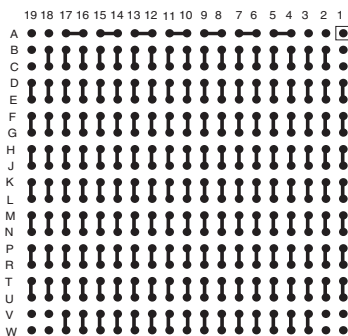

CBGA361T1.27-DC71

Fig. 6

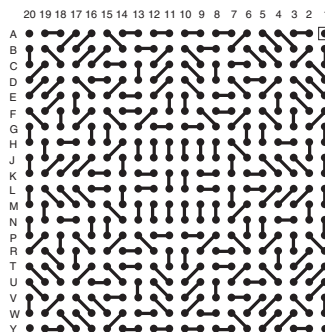

CBGA400T1.27-DC21

Fig. 7

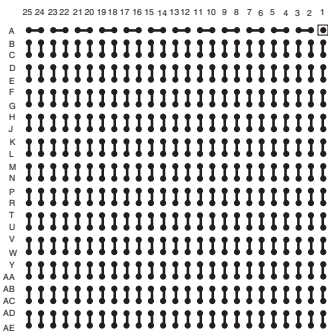

CBGA625T1.27-DC81

Fig. 8

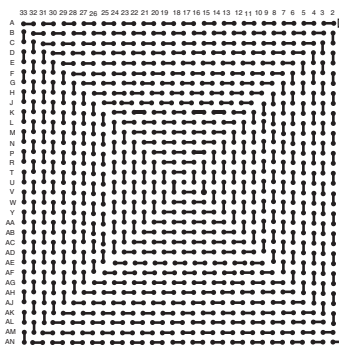

CBGA1089T1.27-DC339

TopLine[®]

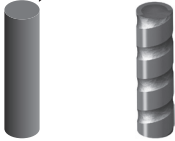

Pb90/Sn10 Plain Pb80/Sn20 Cu Wrap

CCGA COLUMN GRID ARRAY 1.0 ~ 1.27mm PITCH DAISY CHAIN

Visit www.CCGA.co

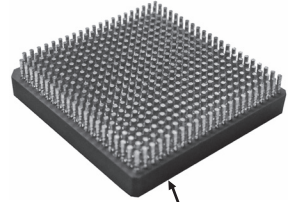

Ceramic Substrate
Daisy Chain

DUMMY COMPONENT ORDERING INFORMATION

FIG	NBR PADS	BODY SIZE	PITCH	PAD MATRIX	ALLOY	COPPER WRAP COLUMN	XJ1 Tray Part Number	QTY
CCGA - Pb80/Sn20 Columns								
1	484	23mm	1.0mm	22x22	Pb80/Sn20	YES	CCGA484T1.0-DC225D	1
2	624	32.5mm	1.27mm	25x25	Pb80/Sn20	YES	CCGA624T1.27-DC254D	1
3	896	31mm	1.0mm	30x30	Pb80/Sn20	YES	CCGA896T1.0-DC308D	1
4	1152	35mm	1.0mm	34x34	Pb80/Sn20	YES	CCGA1152T1.0-DC346D	1
5	1272	37.5mm	1.0mm	36x36	Pb80/Sn20	YES	CCGA1272T1.0-DC367D	1
6	1657	42.5mm	1.0mm	41x41	Pb80/Sn20	YES	CCGA1657T1.0-DC417D	1
7	1752	45mm	1.0mm	42x42	Pb80/Sn20	YES	CCGA1752T1.0-DC427CN	1
CLGA - Without Columns								
2	624	32.5mm	1.27mm	25x25	Ni/Au	PAD	CLGA624T1.27-DC254D	1
4	1152	35mm	1.0mm	34x34	Ni/Au	PAD	CLGA1152T1.0-DC346D	1
5	1272	37.5mm	1.0mm	36x36	Ni/Au	PAD	CLGA1272T1.0-DC367D	1
6	1657	42.5mm	1.0mm	41x41	Ni/Au	PAD	CLGA1657T1.0-DC417D	1
7	1752	45mm	1.0mm	42x42	Ni/Au	PAD	CLGA1752T1.0-DC427CN	1

Fig. 1

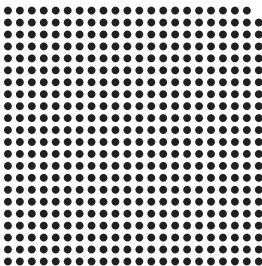

CCGA484T1.0-DC225D

Fig. 2

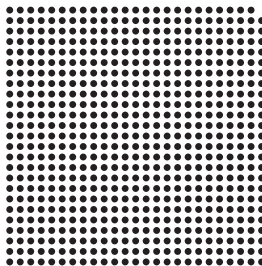

CCGA624T1.27-DC254D

Fig. 4

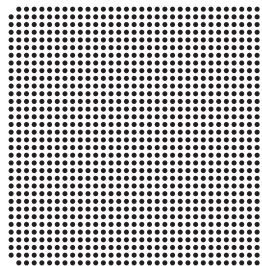

CCGA1152T1.0-DC346D

Fig. 5

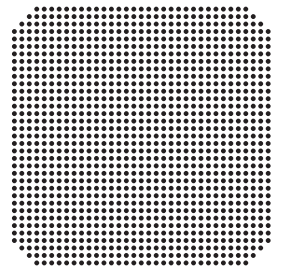

CCGA1272T1.0-DC367D

- I** CCGA - Daisy chain Ceramic Column Grid Arrays are available with three types of pin constructions:
- N** Pb80/Sn20 solder column with copper wrapping provides reliable safety-net in case of cracking in column.
- F** Pb90/Sn10 straight solder column without copper wrap is basic IBM style pin construction.
- O** Micro-Coil Springs - Invented by NASA. Tiny Be-Cu (Beryllium Copper) springs absorb extreme shock.

BGA PLASTIC BALL GRID ARRAY 1.5MM PITCH

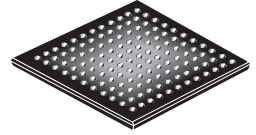

DUMMY COMPONENT ORDERING INFORMATION

NBR FIG	BODY BALLS	BALL SIZE	BALL PATTERN	MATRIX	 Tray Part Number	QTY
1	169	23mm	Full Array	13 x 13	BGA169T1.5-DC10	60
2	225	27mm	Full Array	15 x 15	BGA225T1.5-DC15	40

BGA DAISY CHAIN PATTERNS (BALL VIEW) - ILLUSTRATIONS NOT TO SCALE

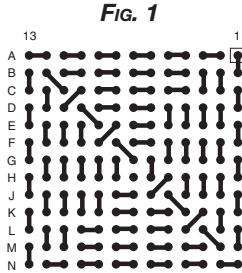

BGA169T1.5-DC10

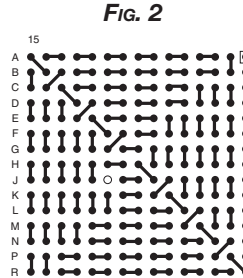

BGA225T1.5-DC15

SIDE VIEW

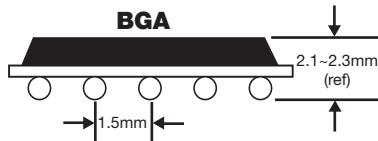

I N F O BGA - Standard BGA plastic packages should be baked at 125°C for 24 hours prior to assembly to prevent delamination and the “popcorn” phenomena during the assembly process. Solder balls are eutectic 63/37 SnPb 30mil (0.75mm)

 - Lead Free Available: Add “C” after pitch in part number for SnAgCu balls.



BGA MAXIMUM BALL COUNT

Rows Matrix	1	2	3	4	5	6	7	8	9	10	11	12	13	14	15	16	17	18	19	20	21	22	23
6x6	20	32	36																				
7x7	24	40	49																				
8x8	28	48	60	64																			
9x9	32	56	72	80	81																		
10x10	36	64	84	96	100																		
11x11	40	72	96	112	120	121																	
12x12	44	80	108	128	140	144																	
13x13	48	88	120	144	160	168	169																
14x14	52	96	132	160	180	192	196																
15x15	56	104	144	176	200	216	224	225															
16x16	60	112	156	192	220	240	252	256															
17x17	64	120	168	208	240	264	280	288	289														
18x18	68	128	180	224	260	288	308	320	324														
19x19	72	136	192	240	280	312	336	352	360	361													
20x20	76	144	204	256	300	336	364	384	396	400													
21x21	80	152	216	272	320	373	392	416	432	440	441												
22x22	84	160	228	288	340	384	420	448	468	480	484												
23x23	88	168	240	304	360	408	448	480	504	520	528	529											
24x24	92	176	252	320	380	432	476	512	540	560	572	576											
25x25	96	184	264	336	400	456	504	544	576	600	616	624	625										
26x26	100	192	276	352	420	480	532	576	612	640	660	672	676										
27x27	104	200	288	368	440	504	560	608	648	680	704	720	728	729									
28x28	108	208	300	384	460	528	588	640	684	720	748	768	780	784									
29x29	112	216	312	400	480	552	616	672	720	760	792	816	832	840	841								
30x30	116	224	324	416	500	576	644	704	756	800	836	864	884	896	900								
31x31	120	232	336	432	520	600	672	736	792	840	880	912	936	952	960	961							
32x32	124	240	348	448	540	624	700	768	828	880	924	960	988	1008	1020	1024							
33x33	128	248	360	464	560	648	728	800	864	920	968	1008	1040	1064	1080	1088	1089						
34x34	132	256	372	480	580	672	756	832	900	960	1012	1056	1092	1120	1140	1152	1156						
35x35	136	264	384	496	600	696	784	864	936	1000	1056	1104	1144	1176	1200	1216	1224	1225					
36x36	140	272	396	512	620	720	812	896	972	1040	1100	1152	1196	1232	1260	1280	1292	1296					
37x37	144	280	408	528	640	744	840	928	1008	1080	1144	1200	1248	1288	1320	1344	1360	1368	1369				
38x38	148	288	420	544	660	768	868	960	1044	1120	1188	1248	1300	1344	1380	1408	1428	1440	1444				
39x39	152	296	432	560	680	792	896	992	1080	1160	1232	1296	1352	1400	1440	1472	1496	1512	1520	1521			
40x40	156	304	444	576	700	816	924	1024	1116	1200	1276	1344	1404	1456	1500	1536	1564	1584	1596	1600			
41x41	160	312	456	592	720	840	952	1056	1152	1240	1320	1392	1456	1512	1560	1600	1632	1656	1672	1680	1681		
42x42	164	320	468	608	740	864	980	1088	1188	1280	1364	1440	1508	1568	1620	1664	1700	1728	1748	1760	1764		
43x43	168	328	480	624	760	888	1008	1120	1224	1320	1408	1488	1560	1624	1680	1728	1768	1800	1824	1840	1848	1849	
44x44	172	336	492	640	780	912	1036	1152	1260	1360	1452	1536	1612	1680	1740	1792	1836	1872	1900	1920	1932	1936	
45x45	176	344	504	656	800	936	1064	1184	1296	1400	1496	1584	1664	1736	1800	1856	1904	1944	1976	2000	2016	2024	2025



eWLP EMBEDDED CSP DIE 0.3 ~ 0.4mm PITCH

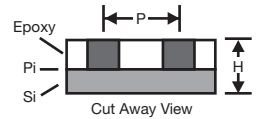

DUMMY COMPONENT ORDERING INFORMATION

FIG	NBR PADS	DIE SIZE	(P) PITCH	PAD MATRIX	PAD DIAMETER	(H) DIE THICKNESS	Tray Part Number XJ1	QTY
1	4	0.56mm	0.3mm	2x2	0.15mm	200um and 360um	eWLP4T.3-DC022	400
2	16	1.16mm		4x4			eWLP16T.3-DC048	400
3	36	1.76mm		6x6			eWLP36T.3-DC067	225
4	64	2.36mm		8x8			eWLP64T.3-DC088	100
5	100	2.96mm		10x10			eWLP100T.3-DC108	100
6	144	3.56mm		12x12			eWLP144T.3-DC127	100
7	196	4.16mm		14x14			eWLP196T.3-DC148	49
1	4	0.76mm	0.4mm	2x2	0.20mm	200um and 360um	eWLP4T.4-DC022	625
2	16	1.56mm		4x4			eWLP16T.4-DC048	100
3	36	2.36mm		6x6			eWLP36T.4-DC067	100
4	64	3.16mm		8x8			eWLP64T.4-DC088	100
5	100	3.96mm		10x10			eWLP100T.4-DC108	49
6	144	4.76mm		12x12			eWLP144T.4-DC127	64
7	196	5.56mm		14x14			eWLP196T.4-DC148	36

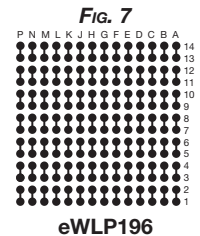
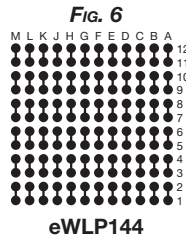
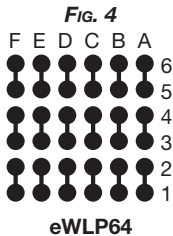
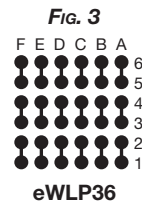
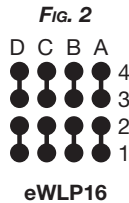
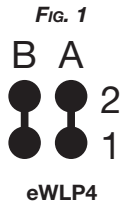

**I
N
F
O**

eWLP - New generation of thin CSP silicon die with copper (Cu) posts without surface treatment.
Application is embedding die inside PC boards.
Die thickness: 200um or 360um. Available die face up and face down.
Packaging available: Waffle Pack, T&R and Wafer on UV Tape and Ring.

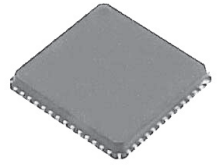

DUMMY COMPONENT ORDERING INFORMATION

BODY SIZE SQ	NBR LEAD		TAPE INFO		Tray Part Number	QTY	Tube Part Number	QTY		
	LEADS	PITCH	WIDTH	PITCH						
QFN										
2mm	6	0.5mm	8mm	8mm	DFN6E7A.5	Reel	DFN6B.5	Bulk		
2mm	8	0.5mm			DFN8E7A.5	Reel	DFN8B.5	Bulk		
2mm	6	0.65mm			DFN6E7A.65	Reel	DFN6B.65	Bulk		
2mm	8	0.5mm			DFN8E7A.5	Reel	DFN8B.5	Bulk		
3mm	10	0.5mm			DFN10T.5	490	DFN10M.5	121		
3mm	12	0.5mm			QFN12T.5	490	QFN12M.5	121		
4mm	12	0.65mm	12mm	8mm	QFN12T.65	490	QFN12M.65	91		
3mm	16	0.5mm			QFN16T.5	490	QFN16M.5	121		
4mm	16	0.65mm			QFN16T.65	490	QFN16M.65	91		
5mm	16	0.8mm			QFN16T.8	490	QFN16M.8	73		
4mm	20	0.5mm			QFN20T.5	490	QFN20M.5	91		
4mm	24	0.5mm			QFN24T.5	490	QFN24M.5	91		
6mm	24	0.8mm			QFN24T.8	490	QFN24M.8	61		
5mm	28	0.5mm			QFN28T.5	490	QFN28M.5	73		
5mm	32	0.5mm			QFN32T.5	490	QFN32M.5	73		
6mm	28	0.65mm			QFN28T.65	490	QFN28M.65	61		
8mm	32	0.8mm			16mm	12mm	QFN32T.8	260	QFN32M.8	46
7mm	32	0.65mm			12mm	18mm	QFN32T.65	260	QFN32M.65	42
6mm	40	0.5mm	QFN40T.5	490			QFN40M.5	61		
7mm	44	0.5mm	16mm	12mm	QFN44T.5	260	QFN44M.5	52		
8mm	44	0.65mm			QFN44T.65	260	QFN44M.65	46		
7mm	48	0.5mm			QFN48T.5	260	QFN48M.5	42		
8mm	52	0.5mm			QFN52T.5	260	QFN52M.5	37		
8mm	56	0.5mm			QFN56T.5	260	QFN56M.5	37		
9mm	64	0.5mm			QFN64T.5	260	QFN64M.5	33		
10mm	68	0.5mm	24mm	16mm	QFN68T.5	168	QFN68M.5	30		
10mm	72	0.5mm			QFN72T.5	168	QFN72M.5	30		
12mm	80	0.5mm			QFN80T.5	189	-	-		

Bottom View of Pads

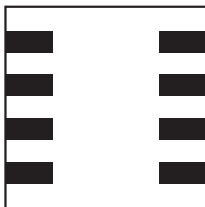

DFN - DUAL SIDE

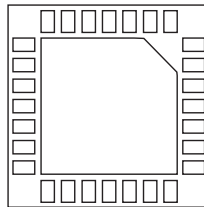

QFN

PART NUMBER

Options	Suffix
Standard	Blank
Daisy Chain	-DE
Isolated	-ISO
Lead Free	-TIN (Sn100)
Lead Free	-F (NiPdAu)
Lead Free	-G (NiAu)

I N F O Perimeter lead CSP utilize lead frame in an epoxy molded plastic case. Offered with daisy chain, add -DE to end of part number. Available in tubes, trays and on reels.
Standard Lead Plating 85Sn/15Pb.

Lead Free. Suffix -TIN = Sn100 G = Ni-Au, "F" = NiPdAu

DAISY CHAIN QFN (TOP VIEW)

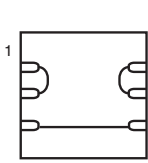

6L

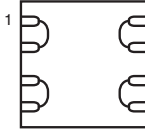

8L

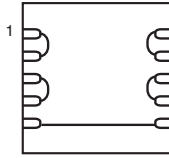

10L

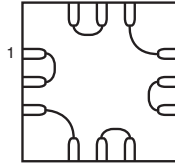

12L

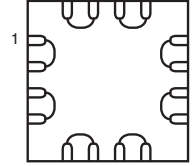

16L

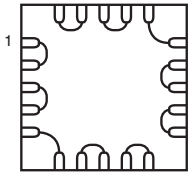

20L

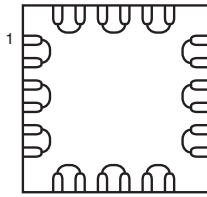

24L

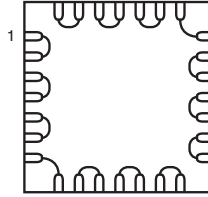

28L

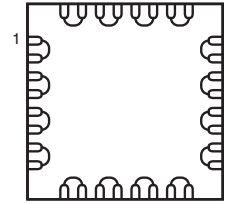

32L

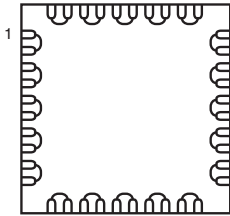

40L

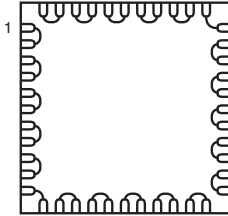

44L

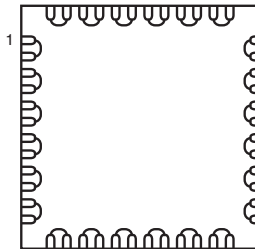

48L

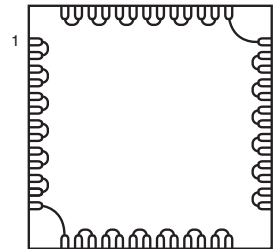

52L

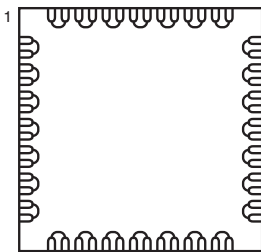

56L

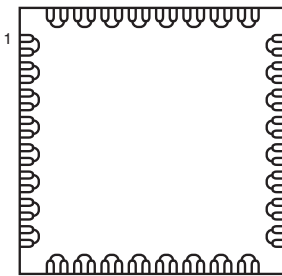

64L

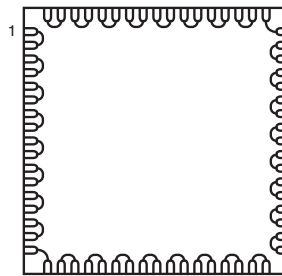

68L

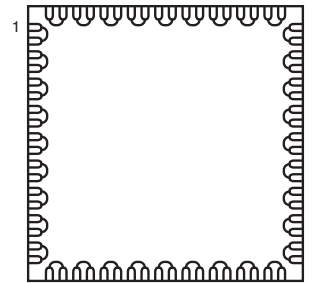

72L



OPEN CAVITY M-QFN ATTACH YOUR DIE

See details pages 152-155

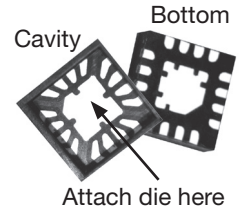

ORDERING INFORMATION

BODY SIZE SQ	NBR LEAD		DIE PAD SIZE mm	PART NUMBER	LID COVER PART NBR (OPTIONAL)
	LEADS	PITCH			
Open Cavity					
3mm	8	0.65mm	1.4 SQ	M-QFN8W.65	B-LID3-BLACK
3mm	12	0.5mm	1.4 SQ	M-QFN12W.5	B-LID3-BLACK
3mm	16	0.5mm	1.4 SQ	M-QFN12W.5	B-LID3-BLACK
4mm	16	0.65mm	2.4 SQ	M-QFN16W.65	B-LID4-BLACK
4mm	20	0.5mm	2.4 SQ	M-QFN20W.5	B-LID4-BLACK
4mm	24	0.5mm	2.4 SQ	M-QFN24W.5	B-LID4-BLACK
5mm	28	0.5mm	3.4 SQ	M-QFN28W.5	B-LID5-BLACK
5mm	32	0.5mm	3.4 SQ	M-QFN32W.5	B-LID5-BLACK
5mm	40	0.4mm	3.4 SQ	M-QFN40W.4	B-LID5-BLACK
6mm	40	0.5mm	4.4 SQ	M-QFN40W.5	B-LID6-BLACK
6mm	48	0.4mm	4.4 SQ	M-QFN48W.4	B-LID6-BLACK
7mm	48	0.5mm	5.4 SQ	M-QFN48W.5	B-LID7-BLACK
8mm	56	0.5mm	6.4 SQ	M-QFN56W.5	B-LID8-BLACK
10mm	72	0.5mm	8.4 SQ	M-QFN72W.5	B-LID10-BLACK
12mm	80	0.5mm	10.4 SQ	M-QFN80W.5	B-LID12-BLACK

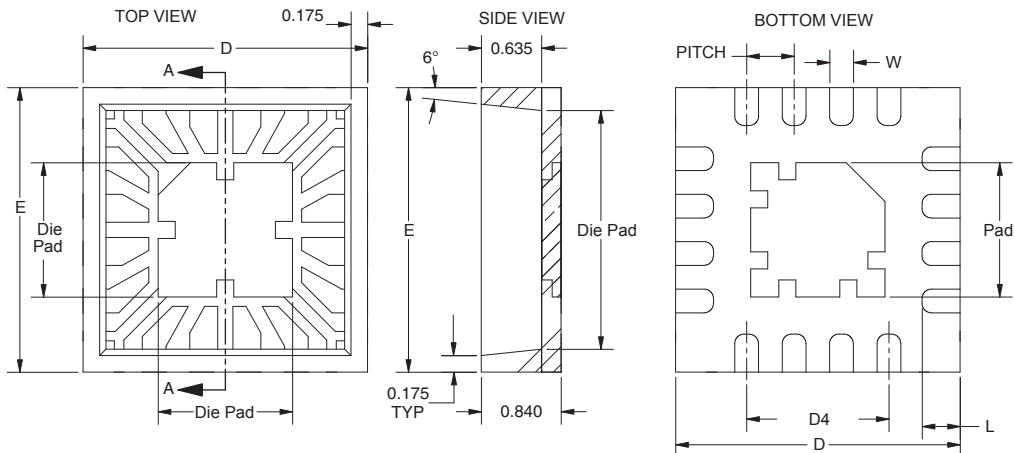

INFO

Open cavity. Attach and wire bond your own die.

Wire bondable. Applications: MEMS, RF Microwave. Fabless prototype, Socket probing

Visit www.MirrorSemi.com for drawings

DIP DUAL INLINE PACKAGE

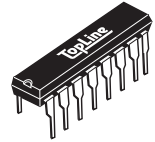

DUMMY COMPONENT ORDERING INFORMATION

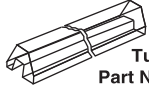
NBR LEADS	CASE LENGTH INCH	CASE LENGTH METRIC	XN1		QTY
				Tube Part Number	
300 MIL WIDE BODY					
2	.100	2.54mm		DIP2M3	200
8	.360"	9.1mm		DIP8M3	50
14	.760"	19.3mm		DIP14M3	25
16	.760"	19.3mm		DIP16M3	25
18	.890"	22.6mm		DIP18M3	21
20	.960"	24.1mm		DIP20M3	18
24	1.25"	31.7mm		DIP24M3	15
28	1.35"	34.5mm		DIP28M3	14
600 MIL WIDE BODY					
24	1.25"	31.7mm		DIP24M6	15
28	1.45"	36.8mm		DIP28M6	13
32	1.65"	41.9mm		DIP32M6	11
40	2.05"	52.0mm		DIP40M6	9
48	2.40"	60.9mm		DIP48M6	9
SDIP 70MIL PITCH					
32	.4" x 1.10"	10.16 x 27.8mm		SDIP32M4	16
42	.6" x 1.45"	15.24 x 36.8mm		SDIP42M6	14
52	.6" x 1.81"	15.24 x 46.0mm		SDIP52M6	11
56	.3" x 2.06"	15.24 x 52.3mm		SDIP56M6	9
64	.75" x 2.27"	19.05 x 57.6mm		SDIP64M7.5	9

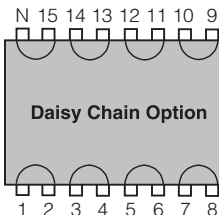

Daisy Chain
available on special order
Add -DE to end of part number



PART NUMBER	
Options	Suffix
Standard	Blank
Daisy Chain	-DE
Isolated	-ISO
Lead Free	-TIN (Sn100)

**I
N
F
O** TopLine supplies DIP Plastic Dual Inline Packages with lead pitch of 0.100" (2.54mm). Also available with Ceramic Case on special order, by adding "CER" prefix to front of part number. SDIP packages have lead pitch of 0.07" (1.778mm). For completely isolated (no internal connections) add -ISO to end of part number.

 For Lead Free option, add -TIN to end of part number.

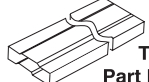

DUMMY COMPONENT ORDERING INFORMATION

MATERIAL							
CASE	LEAD	XT1 Part Number	XT1 Part Number	XT1 Part Number			
		QTY	QTY	QTY			
Metal	Solder	TO5	25	-	-	-	-
Metal	Solder	TO18	25	-	-	-	-
Metal	Solder	TO39	25	-	-	-	-
Metal	Solder	TO75	25	-	-	-	-
Plastic	Solder	TO92	100	-	-	-	-
Plastic	Solder	TO92-.2"	100	-	-	TO92T-.2"	2000
Metal	Solder	TO99	25	-	-	-	-
Plastic	Solder	TO220-3	-	TO220M-3	50	-	-
Metal	Cu-Kovar	TO254	-	-	-	-	-
Metal	Cu-Kovar	TO257	-	-	-	-	-

 For Lead Free add -TIN to end of part number.

TO5 (1.25" LEAD LENGTH)
TO39 (.75" LEAD LENGTH)

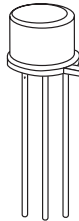

TO18



TO75 6 LEAD
TO99 8 LEAD

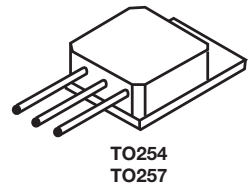
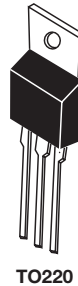
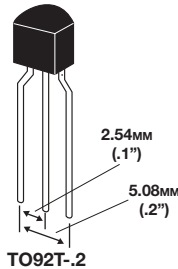
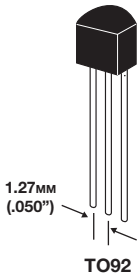
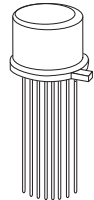

SOLDER TERMINALS

For Hand Soldering Proficiency

IPC COMPLIANT

DUMMY COMPONENT ORDERING INFORMATION

TERMINAL TYPE	XMO		XMO		XMO		XMO	
	Bulk Part Number		Bulk Part Number		Bulk Part Number		Bulk Part Number	
	PN	QTY	PN	QTY	PN	QTY	PN	QTY
Bifurcated	103005	5	103025	25	103100	100	103999	1000
Gold Cup	104005	5	104025	25	104100	100	104999	1000
Hook	105005	5	105025	25	105100	100	105999	1000
Pierced	106005	5	106025	25	106100	100	106999	1000
Turret	107005	5	107025	25	107100	100	107999	1000
20 AWG Wire Black	108020	5FT	108120	100 FT	108520	1000 FT	108920	5000 FT
22 AWG Wire Red	108022	5FT	108122	100 FT	108522	1000 FT	108922	5000 FT
24 AWG Wire Yellow	108024	5FT	108124	100 FT	108524	1000 FT	108924	5000 FT
26 AWG Wire Blue	108026	5FT	108126	100 FT	108526	1000 FT	108926	5000 FT
Terminal Holder	109000	1	-	-	-	-	-	-
Kit of Above	102000	1	-	-	-	-	-	-
Kit without Terminal Holder	101000	1	-	-	-	-	-	-

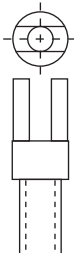

Bifurcated Terminal Brass

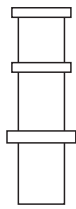

Turret Terminal Brass



Gold Cup Terminal



Pierced Terminal



Hook Terminal

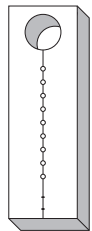

Terminal Holder

**I
N
F
O**

IPC style terminals for hand soldering proficiency. Also available in kit form



CF - RESISTOR



DO - DIODE

DUMMY COMPONENT ORDERING INFORMATION

SIZE INCH DIA X L	SIZE METRIC DIA X L	LEAD DIA.	BODY	Bulk		Tape	
				Part Number XA1	QTY	Part Number XA1	QTY
.062" x .145"	1/8 Watt Size	0.5mm	Epoxy	CF18	100	CF18A	5000
.090" X .250"	1/4 Watt Size	0.6mm	Epoxy	CF14	100	CF14A	5000
.140" X .375"	1/2 Watt Size	0.6mm	Epoxy	CF12	100	CF12A	2500
.180" x .562"	1 Watt Size	0.8mm	Epoxy	CF100	100	CF100A	1K
GLASS CASE							
.070" X .154"	1.78 X 3.9mm	.020"	Glass	DO35	100	DO35A	5000
.107x.205"	2.72 x 5.2mm	.031"	Glass	DO41-GLASS	100	DO41A-GLASS	2500
MOLDED CASE							
.107" x .205"	2.72 x 5.2mm	.031"	Molded	DO41	100	DO41A	2500
.209" x .374"	5.3 x 9.5mm	.051"	Molded	DO201AD	100	DO201AD-A	1200

RADIAL LEAD COMPONENTS

DUMMY COMPONENT ORDERING INFORMATION

LEAD SPACE		CASE SIZE		Tube Part Number		Bulk Part Number		Tape Part Number	
INCH	METRIC	INCH	METRIC	XR1	QTY	XR1	QTY	XR1	QTY
.1"	2.5mm	.2" SQ	5mm SQ	-	-	NR1	100	NR1A	2000
		.2" x .28"	5 x 7mm	-	-	EH5x7	100	EH5x7A	2000
		.2" x .6"	5 x 15mm	RS6M	35-40	RS6	300	Call	Call
		.2" x .8"	5 x 20mm	RS8M	25-30	RS8	200	Call	Call
		.2" x 1.0"	5 x 26mm	RS10M	20-24	RS10	150	Call	Call
.2"	5.7mm	.2" SQ	5mm	-	-	CK05	100	CK05T	2000
		.2" SQ	5mm	-	-	NR2	100	NR2A	2000
		.3" SQ	7.60mm	-	-	CK06	100	CK06T	1500
		.2 x .31	5 x 8mm	-	-	DD2	100	DD2T	1000
		.20 x .43	5 x 11mm	-	EH5x11	-	100	EH5X11A	1000
		.06 x .15	1/8w	-	-	CFR18	100	CFR18-AVI	2000

NR

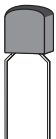

CK05

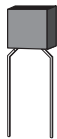

CK06

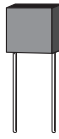

DD2



RS

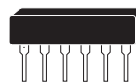

EH



CFR

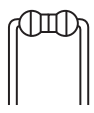

INFO



Lead Free Option: Sn100 add -TIN to end of part number.



WAFFLE TRAYS FOR BARE DIE

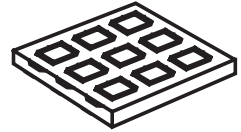

WP	2	5.0 x 5.0 x 0.8
Series	Tray Size	Pocket Dimension (mm)
WP = Waffle Pack	2 = 2" SQ 4 = 4" SQ	Length x Width x Depth of Tray Bottom (blank if bottom tray)

B	Option
Type	Material
B = Black	Blank = Black (standard) A = Amber N = Natural
Cover Suffix	
COVER = Standard Black Cover	
Clip Holds Covers + Bottom	
CLIP1 = Single Clip Holds Tray + Cover CLIP2 = Clip Pair Holds Tray + Cover CLIP5 = Clip Pair Holds 5 Trays + Cover CLIP10 = Clip Pair Holds 10 Trays + Cover	
Insert	
INSERT-PAPER = Rice Paper INSERT-TYVEK = White	
Accessories	
LABEL-BLANK = Unprinted Label (Roll 1000) LABEL-PP = Preprinted Form Roll (Roll 500)	

WAFFLE TRAY CAPACITY (EXAMPLE)*

Pocket Size Sq	2" Square WP2		4" Square WP4	
	Matrix	Pockets	Matrix	Pockets
1mm Sq	20 x 20	400	30 x 30	900
2mm Sq	10 x 10	100	29 x 30	870
3mm Sq	10 x 10	100	16 x 16	256
4mm Sq	8 x 8	64	14 x 14	196
5mm Sq	7 x 7	49	12 x 12	144
6mm Sq	5 x 5	25	11 x 11	121
7mm Sq	5 x 5	25	9 x 9	81
8mm Sq	4 x 4	16	8 x 8	64
9mm Sq	4 x 4	16	8 x 8	64
10mm Sq	3 x 3	9	7 x 7	49
12mm Sq	3 x 3	9	6 x 6	36
13mm Sq	3 x 3	9	6 x 6	36
14mm Sq	3 x 3	9	5 x 5	25
15mm Sq	2 x 2	4	5 x 5	25
17mm Sq	2 x 2	4	4 x 4	16
19mm Sq	2 x 2	4	4 x 4	16
21mm Sq	2 x 2	4	3 x 3	9

*OTHER SIZES AVAILABLE

MATRIX TRAYS FOR BGA BALL GRID ARRAY

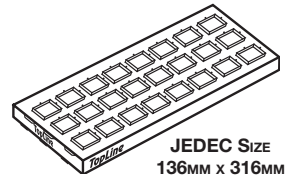

TRAY ORDERING INFORMATION

COMPONENT SIZE PER TRAY	COMPONENTS ROW COLUMN	MATRIX XZ1	 Tray Part Number
5 x 5mm	576	16 x 36	BGATRAY5mm-16x36
5 x 5mm	624	16 x 39	BGATRAY5mm-16x39
5 x 5mm	640	16 x 40	BGATRAY5mm-16x40
6 x 6mm	360	12 x 30	BGATRAY6mm-12x30
6 x 6mm	608	16 x 38	BGATRAY6mm-16x38
7 x 7mm	416	13 x 32	BGATRAY7mm-13x32
7 x 7mm	476	14 x 34	BGATRAY7mm-14x34
8 x 8mm	348	12 x 29	BGATRAY8mm-12x29
8 x 8mm	360	12 x 30	BGATRAY8mm-12x30
9 x 9mm	250	10 x 25	BGATRAY9mm-10x25
10 x 10mm	184	8 x 23	BGATRAY10mm-8x23
10 x 10mm	240	10 x 24	BGATRAY10mm-10x24
10 x 10mm	250	10 x 25	BGATRAY10mm-10x25
11 x 11mm	176	8 x 22	BGATRAY11mm-8x22
12 x 12mm	189	9 x 21	BGATRAY12mm-9x21
12 x 12mm	198	9 x 22	BGATRAY12mm-9x22
13 x 13mm	160	8 x 20	BGATRAY13mm-8x20
14 x 14mm	152	8 x 19	BGATRAY14mm-8x19
14 x 14mm	119	7 x 17	BGATRAY14mm-7x17
15 x 15mm	126	7 x 18	BGATRAY15mm-7x18
16 x 16mm	119	7 x 17	BGATRAY16mm-7x17
17 x 17mm	90	6 x 15	BGATRAY17mm-6x15
19 x 19mm	84	6 x 14	BGATRAY19mm-6x14
21 x 21mm	60	5 x 12	BGATRAY21mm-5x12
23 x 23mm	60	5 x 12	BGATRAY23mm-5x12
25 x 25mm	44	4 x 11	BGATRAY25mm-4x11
27 x 27mm	40	4 x 10	BGATRAY27mm-4x10
31 x 31mm	27	3 x 9	BGATRAY31mm-3x9
35 x 35mm	24	3 x 8	BGATRAY35mm-3x8
37.5 x 37.5mm	21	3 x 7	BGATRAY37.5mm-3x7
40 x 40mm	21	3 x 7	BGATRAY40mm-3x7
42.5 x 42.5mm	12	2 x 6	BGATRAY42.5mm-2x6
45 x 45mm	12	2 x 6	BGATRAY45mm-2x6
47.5 x 47.5mm	12	2 x 6	BGATRAY47.5mm-2x6
6 x 7mm	160	10 x 16	BGATRAY6x7-10x16
6 x 8mm	260	10 x 26	BGATRAY6x8-10x26
7 x 9mm	325	13 x 25	BGATRAY7x9mm-13x25
14 x 22mm	84/96	7 x 12 6 x 14 8 x 12	BGATRAY14x22-6x14
21 x 25mm	55	5 x 11	BGATRAY21x25-5x11

**I
N
F
O**

Specify minimum temperature rating: 50°C, 75°C, 125°C, 130°C, 140°C, 150°C or 180°C

MATRIX TRAYS FOR QFP & QFN

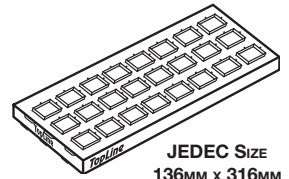

JEDEC Size
136MM x 316MM

DUMMY COMPONENT ORDERING INFORMATION

COMPONENT BODY SIZE	COMPONENT HEIGHT	COMPONENTS PER TRAY	MATRIX COLUMN X ROW	 Tray Part Number <small>XZ1</small>
QFP TRAY				
10mm Sq.	2.0mm	96	6 x 16	QTRAY10mm-6x16
14mm Sq.	2.0-2.7mm	84	6 x 14	QTRAY14mm-6x14
14 x 20mm	2.7mm	66	6 x 11	QTRAY14x20mm-6x11
28mm Sq.	3.6mm	24	3 x 8	QTRAY28mm-3x8
32mm Sq.	3.8mm	24	3 x 8	QTRAY32mm-3x8
40mm Sq.	3.8mm	12	3 x 4	QTRAY40mm-3x4
LQFP TRAY				
7mm Sq.	1.4mm	250	10 x 25	LQTRAY7mm-10x25
10mm Sq.		160	8 x 20	LQTRAY10mm-8x20
12mm Sq.		119	7 x 17	LQTRAY12mm-7x17
14mm Sq.		90	6 x 15	LQTRAY14mm-6x15
14 x 20mm		72	6 x 12	LQTRAY14x20mm-6x12
20mm Sq.		60	5 x 12	LQTRAY20mm-5x12
24mm Sq.		40	4 x 10	LQTRAY24mm-4x10
28mm Sq.		36	4 x 9	LQTRAY28mm-4x9
TQFP TRAY				
5mm Sq.	1.0mm	360	12 x 30	TQTRAY5mm-12x30
7mm Sq.		250	10 x 25	TQTRAY7mm-10x25
10mm Sq.		160	8 x 20	TQTRAY10mm-8x20
12mm Sq.		119	7 x 17	TQTRAY12mm-7x17
14mm Sq.		90	6 x 15	TQTRAY14mm-6x15
14 x 20mm		72	6 x 12	TQTRAY14x20mm-6x12
20mm Sq.		60	5 x 12	TQTRAY20mm-5x12
QFN TRAY				
3mm Sq.	0.9mm	490	14 x 35	QFNTRAY3mm-14x35
4mm Sq.		490	14 x 35	QFNTRAY4mm-14x35
5mm Sq.		490	14 x 35	QFNTRAY5mm-14x35
6mm Sq.		490	14 x 35	QFNTRAY6mm-14x35
7mm Sq.		260	10 x 26	QFNTRAY7mm-10x26
8mm Sq.		260	10 x 26	QFNTRAY8mm-10x26
9mm Sq.		260	10 x 26	QFNTRAY9mm-10x26
10mm Sq.		168	8 x 21	QFNTRAY10mm-8x21

**I
N
F
O**

Specify minimum temperature rating at time of ordering: 50°C, 75°C, 125°C, 130°C, 140°C, 150°C or 180°C



MATRIX TRAYS FOR TSOP & PLCC

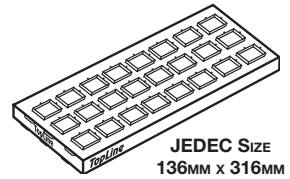

DUMMY COMPONENT ORDERING INFORMATION

COMPONENT SIZE	COMPONENT HEIGHT	COMPONENTS PER TRAY	MATRIX ROW X COLUMN	 Tray Part Number
TYPE I (INCLUDING LEADS)				
8 x 13.4mm	1.0-1.2mm	234	13 x 18	TTRAY8x13.4mm-13x18
10 x 14mm		160	10 x 16	TTRAY10x14mm-10x16
8 x 20mm		156	12 x 13	TTRAY8x20mm-12x13
10 x 20mm		120	10 x 12	TTRAY10x20mm-10x12
12 x 20mm		96	8 x 12	TTRAY12x20mm-8x12
14 x 20mm		91	7 x 13	TTRAY14x20mm-7x13
TYPE II (BODY SIZE)				
.4" x .725" (10.16 x 18.4mm)	1.0-1.2mm	135	9 x 15	T2TRAY10x18.4-9x15
.4" x .825" (10.16 x 20.95mm)		117	9 x 13	T2TRAY10x21-9x13
.4" x .875" (10.16 x 22.22)		108	9 x 12	T2TRAY10x22-9x12

TRAY FOR J-LEAD, PLCC, LCC AND CLCC

COMPONENT SIZE	COMPONENT HEIGHT	COMPONENTS PER TRAY	MATRIX ROW X COLUMN	 Tray Part Number
PLCC32	4.4mm	128	8 x 16	PLCC32TRAY-8x16
PLCC44	4.4mm	40	4 x 10	PLCC44TRAY-4x10
PLCC44	3.6mm	84	6x14	PLCC44TRAY6x14
PLCC52	4.4mm	36	4 x 9	PLCC52TRAY-4x9
PLCC68	4.4mm	21	3 x 7	PLCC68TRAY-3x7
PLCC84	4.4mm	21	3 x 7	PLCC84TRAY-3x7

KIT PART NUMBERING SYSTEM

WEBCODE XK1



926

025

SERIES	
900 = QFP Lead Template	945 = PCMCIA
901 = FC176 Flip Chip	946 = Universal BGA 1.27/1.5mm
902 = FC88 Flip Chip	947 = BGA256/272/292/352/388
903 = FC317 Flip Chip	948 = Monster 2 *
904 = FC220 Flip Chip	949 = 0201/0402 Chip
905 = CBGA Ceramic Substrates	950 = SMTA Saber
906 = FC96 Ceramic	951 = CBGA
907 = FC96 Lamanate	952 = B52 CRET Cleanliness
908 = FC48 Ceramic	953 = Visual BGA & Flip Chip
909 = FC48 Flip Chip	954 = HP Saber Alloy Test
910 = Beginner Throughhole	955 = DIE KIT *
911 = FC112 Flip Chip	956 = CLGA
912 = Recertification Mix Tech	957 = CBGA196/625 *
913 = Multilayer Throughhole	958 = LBGA1089/1225
914 = Mixed Technology 2	959 = 2D Matrix & Bar Codes
915 = Multipurpose Throughhole	960 = Machine Diagnostic *
916 = Multipurpose Throughhole	961 = Fiducial Comparator
917 = BGA121, 352, 400 (obsolete)	962 = 28mm QFP Assortment
918 = Unassigned *	963 = Universal BGA .5~.8mm
919 = Phillips Machine	964 = 0402/0603 Chip
920 = Challenger 1 (see 928) *	965 = Rework 1 Practice
921 = μBGA TV46	966 = BGA169/225 6L
922 = TV74 (obsolete)	967 = BGA169/225
923 = TV188 (obsolete) *	968 = 0805/1206 Chip
924 = Beginners SMD	969 = Mixed Technology 1
925 = SMD Introductory	970 = Display Boards
926 = Practical Mixed Technology	971 = Label for 970 *
927 = Unassigned	972 = Parts for Display
928 = Challenger 2	973 = CCGA1089/CCGA1274*
929 = Jumbo Chip Set *	974 = eBGA1600/eBGA1936
930 = Advanced w/o QFP256	975 = QFN Daisy Chain
931 = Advanced w/QFP256	976 = BGA256 1.0mm/SBGA560
932 = μBGA TV62	977 = Metcal *
933 = Custom *	978 = Rework 3 Practice
934 = μBGA TV208	979 = NASA Training
935 = Stencil Eval. w/TQFP168	980 = 01005 / 0201 Chip
936 = Stencil Evaluation	981 = Universal BGA 1.0/0.8mm
937 = Econo I - BGA	982 = QFP208 Lead Free
938 = Econo II - Mixed	983 = 0805/1206 Lead Free
939 = Econo III - Mixed	984 = 0402/0603 Lead Free
940 = Monster (see 948) *	985 = Unassigned
941 = Mydata *	986 = Lead Free Multicomponent
942 = Intertronic 2001	999 = Special/Custom *
943 = TQFP168 (obsolete)	9603 = TSOP32 *
944 = Rework 2 Practice	9613 = BQFP132 *

SPECIFICATIONS	
000 = Single Pack Kit (Hand Solder)	
001 = Standard PC Board	
002 = Lead Free Tin Plated Board	
003 = Populated PC Board	
004 = X, Y, Theta Parts Placement ASCII File	
005 = Gerber File For Solder Paste Stencil	
006 = Immersion Silver Board (Lead Free)	
007 = Polyimide Board	
008 = OSP Copper Board Entek (Lead Free)	
009 = Ni Au PC Board	
010 = Kit Of 10	
025 = Kit Of 25	
050 = Kit Of 50	
100 = Kit Of 100	

LEAD FREE (ROHS) Pb-FREE KITS:

2XX = Tin (Sn) Board
6XX = Silver (Ag) Board
8XX = OSP (Cu) Board
9XX = Gold (Ni-Au ENIG) Board
XX = Quantity of Kits

9616 = QFP160 *
9618 = Rotational Test
9621 = QFP208
9625 = QFP256

* = Not Shown in Catalog
See www.topline.tv



GENERAL KIT INFORMATION



FR-4 (STANDARD)

Epoxy-glass FR-4 is standard for most kits. Most Boards are double sided. Tg = 140°C.

FR4 (HIGH TEMP)

High Temp (Tg = 170°C ~ 180°C) is used for Lead Free boards.

POLYIMIDE (OPTIONAL)

For high temperatures during assembly or burn-in. Polyimide Tg is 270°C.

BT (OPTIONAL)

Bismaleimide Triazine available special order.

COPPER THICKNESS

Usually 1.0 oz. of copper.

HOT AIR SOLDER LEVELING (Sn63)

Hot air solder leveling (HASL) during board fabrication gives boards a controlled plating flatness which assures coplanarity for fine pitch components.

LIQUID PHOTO IMAGEABLE SOLDER MASK

Liquid photoimageable (LPI) soldermask with Sanwa Chemical SPSR-950. Taiyo PSR4000 AUS5 is available special order.

X,Y THETA: (ACCESSORY)

Component placement data for pick and place machines. Free download.

GERBER DATA: (ACCESSORY)

For solder paste stencil. Free download.

LEAD-FREE (OPTIONAL)

Available in 4 finishes:

- Sn100 - Immersion (White) Tin
- Au (ENIG) Ni - Immersion Gold
- Ag - Immersion Silver
- OSP - ENTEK 106 Copper

GLOBAL FIDUCIALS

A minimum of two global fiducials are located diagonally opposed as far apart as possible.

LOCAL FIDUCIALS

Used to locate the position of an individual.

GENERAL

Kits are supplied with enough components for one side of the board only.

OSP (OPTIONAL)

Organic Solder Preservative over bare copper such as ENTEK106 is available special order.



RoHS Banned Substances

Substance	Maximum Limit (ppm)
Cadmium (Cd)	100
Lead (Pb)	1000
Mercury (Hg)	1000
Hexavalent Chromium (Cr 6+)	1000
Polybrominated Biphenyls (PBB)	1000
Polybrominated Diphenyl Ethers (PBDE)	1000

About RoHS:

The European Union has adopted Directive 2002/95/EC – the Restriction of Hazardous Substances (RoHS) in electrical and electronic equipment. This legislation bans the use of lead, mercury, cadmium, hexavalent chromium, polybrominated biphenyls (PBB) or polybrominated diphenyl ethers (PBDE) in electrical and electronic devices after July 1, 2006 with certain exemptions.



TopLine offers Lead Free boards with 4 popular finishes compatible with RoHS.

COMPARISON OF LEAD FREE FINISHES			
	Description	Advantages	Concerns
Sn	Immersion Tin (also known as White Tin)	<ul style="list-style-type: none"> • Low Cost • Widely Accepted • Re-workable • Good Flatness • Good Shelf Life 	<ul style="list-style-type: none"> • Potential Whisker • Microscopic Voids
Ag	Immersion Silver	<ul style="list-style-type: none"> • Low Cost • Widely Accepted • Re-workable • Excellent Flatness • Excellent Wetting 	<ul style="list-style-type: none"> • Shelf Life • Tarnishing
OSP Cu	Organic Solderability Preservative Entek CU106 or CU56	<ul style="list-style-type: none"> • Low Cost • Widely Accepted • Re-workable • Excellent Flatness 	<ul style="list-style-type: none"> • Shelf Life • Degrades with Temperature • Handling Sensitivity • Flex Sensitive
Ni-Au	Electroless Nickel Immersion Gold (Also known as ENIG)	<ul style="list-style-type: none"> • Widely Accepted • Excellent Flatness • Very Long Shelf Life 	<ul style="list-style-type: none"> • Added Cost • Difficulty with rework • More brittle solder joints

COMPARISON OF STANDARD FINISHES (WITH Pb)			
	Description	Advantages	Concerns
Sn/Pb	Hot Air Solder Level (also known as HASL)	<ul style="list-style-type: none"> • Low Cost • Widely Accepted • Re-workable • Good Shelf Life 	<ul style="list-style-type: none"> • Flatness (Coplanarity) • Paste Misprints • Not RoHS Compatible

TopLine®



CHIP SHOOTER KIT 01005 AND 0201 CHIPS WITH DAISY CHAIN



Top Side of Board

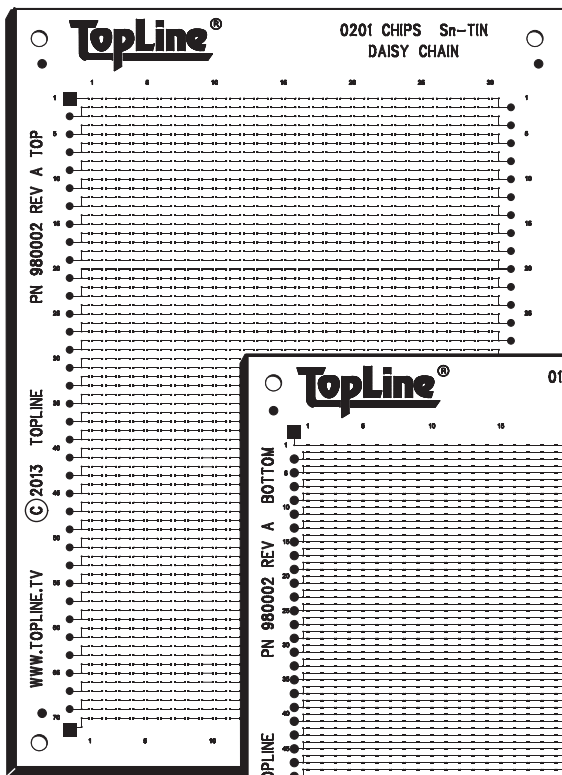

Put your machine to the test with TopLine's new 01005/0201 kits. Double sided board has 2000 pads for 0201 chips on the front side and 3000 pads for 01005 chips on the back side. Components are supplied on 2mm pitch tape. Kit can be used for placement, soldering or epoxy dispenser testing. Many test points for continuity testing.

Bottom Side of Board

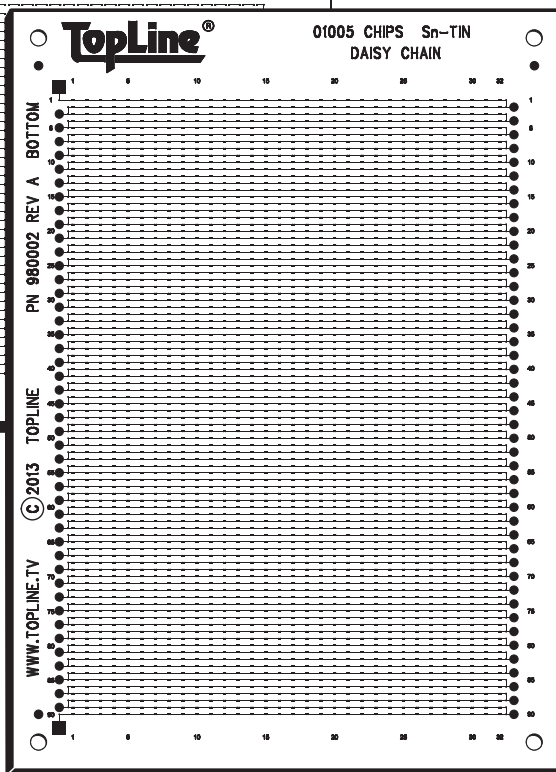

Pad Dimensions (mm)

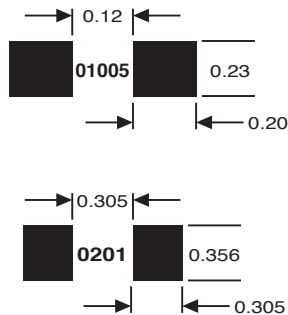

FEATURES

- LPI Solder Mask
- FR4 Board .062" thick
- Double Sided
- Tooling Holes .125"
- Fiducial Marks

Actual Size: 4" x 5.5" (100 x 140mm)



CHIP SHOOTER KIT 01005 AND 0201 CHIPS WITH DAISY CHAIN



KIT ORDERING INFORMATION

COMPONENT	TAPE PITCH	MACHINE RUN				
		ORDER NUMBER 980200 1 KIT	ORDER NUMBER 980203 3 KITS	ORDER NUMBER 980206 6 KITS	ORDER NUMBER 980210 10 KITS	ORDER NUMBER 980225 25 KITS
Board	-	1	3	6	10	25
01005 Chip	2mm	3,000	9,000	18,000	30,000	75,000
0201 Chip	2mm	2,000	6,000	12,000	20,000	50,000

Lead Free (Pb-Free) Option

Description	Spare Board	1 Kit	3 Kits	6 Kits	10 Kits	25 Kits
Lead Free						
Sn - Tin	980002	980200	980203	980206	980210	980225
Au - Gold	980009	980900	980903	980906	980910	980925

Free Solder Paste Gerber + Parts Placement download www.topline.tv/GerbbersFree.cfm

NOTE: 50 and 100 KITS ALSO AVAILABLE

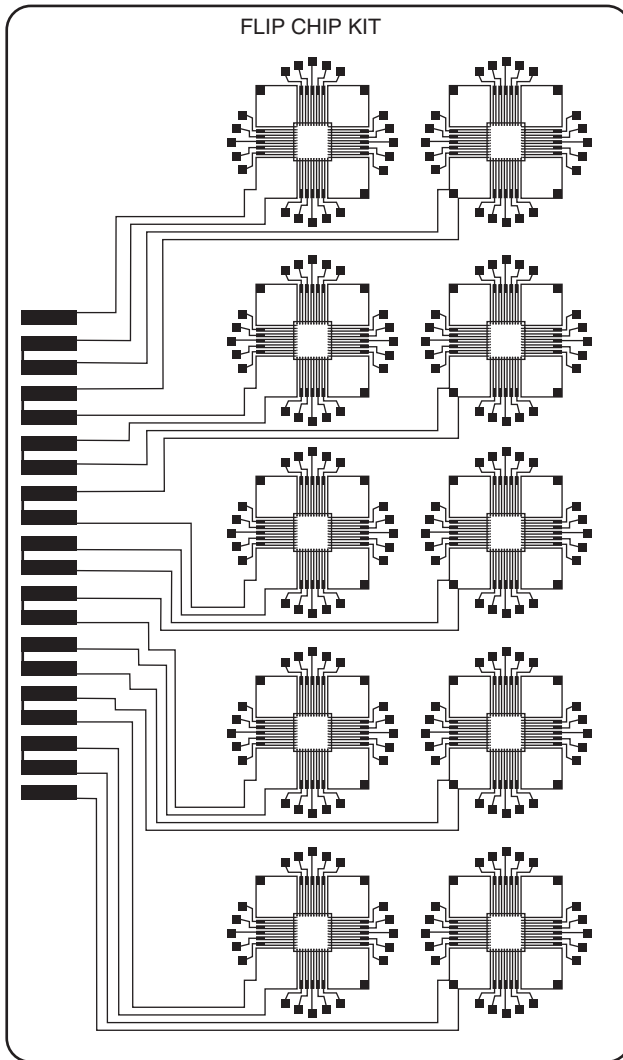

Actual Size: 3.25" x 5.5" (83 x 140mm)

Laminate FR4 board for placement and daisy chain continuity testing after assembly.

Each board has coupon sites for mounting 10 flip chips.

Laminate board features multifunctional high temperature FR4 board ($T_g = 170^\circ\text{C}$)

Plating Options:
Ni-Au Standard
Cu-OSP Available

Board Thickness:
.031" - 0.78mm FC317
.062" - 1.57mm FC48-FC220

NOTE



Gerber Data is only available for laminate boards.



FLIP CHIP KITS



KIT ORDERING INFORMATION

CONTENTS	 MANUAL ASSEMBLY		AND	 MACHINE RUN	
	ORDER NUMBER 902000 1 KIT	ORDER NUMBER 903000 1 KIT		ORDER NUMBER 909000 1 KIT	ORDER NUMBER 911000 1 KIT
Laminate FR4 Board	1	1		1	1
FC48 457µm	0	0		25	0
FC88 204µm	36	0		0	0
FC112 152µm	0	0		0	36
FC317 254µm	0	36		0	0

Lead Free (Pb-Free) Option

Description	FC48	FC88	FC317	FC112
Lead Free Kit Gold Board + SnAgCu Flip Chip	909900	902900	903900	911900
Spare Gold Board	909001	902001	903001	911001
Standard Kit Gold Board + SnPb Flip Chip	909000	902000	903000	911000

Free Solder Paste Gerber + Parts Placement download www.topline.tv/GerbbersFree.cfm

TopLine[®]



BGA46 0.75MM TEST KIT

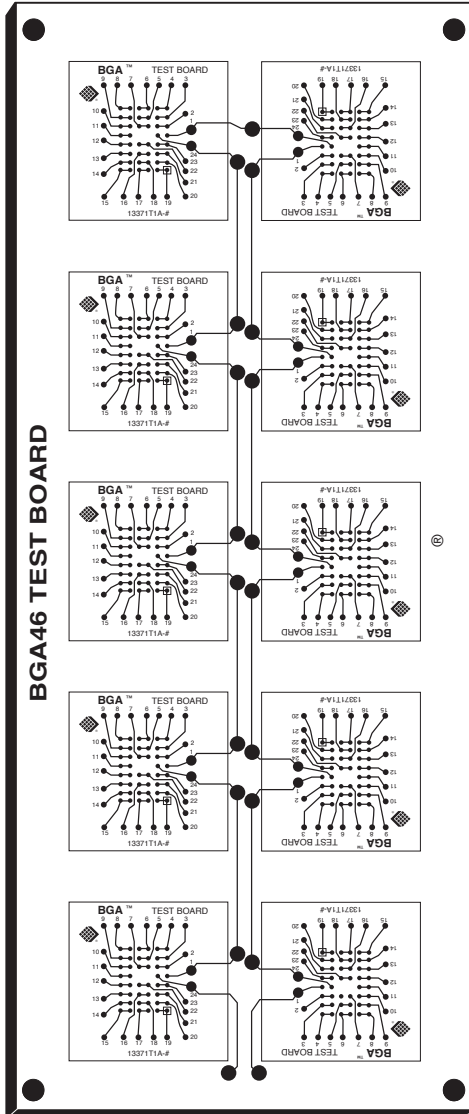

Actual Size 2.75" x 6.5" (70 x 165mm)

Test board for 0.75mm pitch BGA46 chip scale components. Each board has 10 coupons which allow continuity testing of individual components as well as series test of all 10 components.

Parts are supplied in trays.



Pad	Diameter
Bump Site	.012" (.3mm)
Fiducial	.040" (1.0mm)

FEATURES

- Electroless Nickel Immersion Gold Plated
- LPI Solder Mask
- FR4 Board .03" (0.76mm)
- Single Sided, 1/2 oz. copper
- Fiducial Marks



KIT ORDERING INFORMATION

COMPONENT	PITCH	 MANUAL ASSEMBLY	 MACHINE RUN		
		NUMBER 921000 1 KIT	ORDER NUMBER 921010 10 KITS	ORDER NUMBER 921025 25 KITS	ORDER NUMBER 921050 50 KITS
Board BGA46	0.75mm	1 10	10 100	25 250	50 500

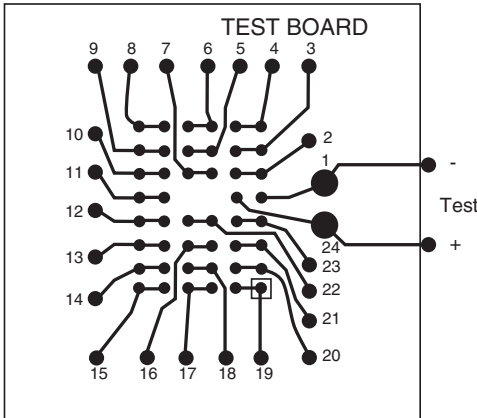

SINGLE PCB TEST COUPON

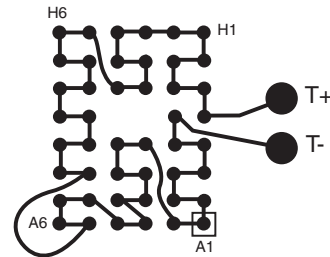

AFTER MOUNTING TO TEST BOARD

Lead Free (Pb-Free) Option

Description	Spare Board	1 Kit	10 Kits	25 Kits	50 Kits	100 Kits
Lead Free Gold Board + SnAgCu BGA	921001	921900	921910	921925	921950	921999
Standard Gold Board + SnPb BGA	921001	921000	921010	921025	921050	921100

Free Solder Paste Gerber + Parts Placement download www.topline.tv/GerbbersFree.cfm

TopLine®



UNIVERSAL CSP KIT 0.5~0.8MM PITCH



TopLine's Universal CSP Kits provide pads capable of mounting 0.5mm, 0.75mm and 0.8mm pitch without daisy chain. Includes fiducial marks for vision equipment.

Uses soldermask defined pads.

TopLine CSP Universal Placement

PN963001 Rev A

© 2000 TopLine

www.TopLineDummy.com

The grid shows the following pad patterns:

- P = 0.5mm 8 x 8
- P = 0.5mm 10 x 10
- P = 0.5mm 12 x 12
- P = 0.5mm 14 x 14
- P = 0.75mm 6 x 8
- P = 0.8mm 7 x 7
- P = 0.8mm 8 x 8
- P = 0.8mm 9 x 9
- P = 0.8mm 10 x 10
- P = 0.8mm 12 x 12
- P = 0.8mm 14 x 14

PAD GEOMETRY		
PAD DIA.	BALL DIA.	PITCH
0.26mm	0.3mm	0.5mm
0.26mm	0.3mm	0.75mm
0.38mm	0.46mm	0.8mm

FEATURES

- LPI Solder Mask
- FR4 Board .062"
- Double Sided
- Tooling Holes

Actual Size 4" x 5.5" (100 x 140mm)



TopLine®



UNIVERSAL CSP KIT 0.5~0.8mm PITCH



KIT ORDERING INFORMATION

COMPONENT	PITCH	 MANUAL ASSEMBLY	 MACHINE RUN	
		ORDER NUMBER 963000 1 KIT	ORDER NUMBER 963010 10 KITS	ORDER NUMBER 963025 25 KITS
Board		1	10	25
CSP	0.5mm	4	40	100
CSP	0.75mm	4	40	100
CSP	0.8mm	4	40	100

Lead Free (Pb-Free) Option

Description	Spare Board	1 Kit	10 Kits	25 Kits	50 Kits	100 Kits
Lead Free						
Sn – Tin	963002	963200	963210	963225	963250	963299
Ag – Silver	963006	963600	963610	963625	963650	963699
Cu – OSP	963008	963800	963810	963825	963850	963899
Au – Gold	963009	963900	963910	963925	963950	963999
Standard						
SnPb – HASL	963001	963000	963010	963025	963050	963100

Free Solder Paste Gerber + Parts Placement download www.topline.tv/GerbbersFree.cfm

TopLine®



UNIVERSAL BGA KIT 0.8/1.0MM PITCH



TopLine BGA Universal Placement

1.0mm pitch

Rev A

P/N 981001

Ø 19mil Ø 20mil Ø 21mil

© 1999 TopLine

Ø 22mil Ø 23mil Ø 24mil

www.TopLineDummy.com

0.8mm pitch

Ø 16mil Ø 17mil Ø 18mil

TopLine's Universal BGA kits are convenient to use. Includes non-daisy chain BGA components for 1.0mm and 0.8mm pitch for placement and solder practice.

Soldermask defined pads with varying apertures from 16mil to 24mil diameter.

FEATURES

- LPI Solder Mask
- FR4 Board .062"
- Double Sided
- Tooling Holes
- Fiducial Marks

Actual Size 4" x 5.5" (100 x 140mm)



TopLine®



UNIVERSAL BGA KIT 0.8/1.0MM PITCH



KIT ORDERING INFORMATION

COMPONENT	PITCH	 MANUAL ASSEMBLY	 MACHINE RUN	
		ORDER NUMBER 981000 1 KIT	ORDER NUMBER 981010 10 KITS	ORDER NUMBER 981025 25 KITS
Board 981001	0.8/1.0mm	1	10	25
BGA	1.0mm	4	40	100
BGA	0.8mm	4	40	100

Lead Free (Pb-Free) Option

Description	Spare Board	1 Kit	10 Kits	25 Kits	50 Kits	100 Kits
Lead Free						
Sn – Tin	981002	981200	981210	981225	981250	981299
Ag – Silver	981006	981600	981610	981625	981650	981699
Cu – OSP	981008	981800	981810	981825	981850	981899
Au – Gold	981009	981900	981910	981925	981950	981999
Standard						
SnPb – HASL	981001	981000	981010	981025	981050	981100

Free Solder Paste Gerber + Parts Placement download www.topline.tv/GerbersFree.cfm

TopLine[®]



FINE PITCH BGA WITH DAISY CHAIN TEST 0.8MM - 1.0MM PITCH

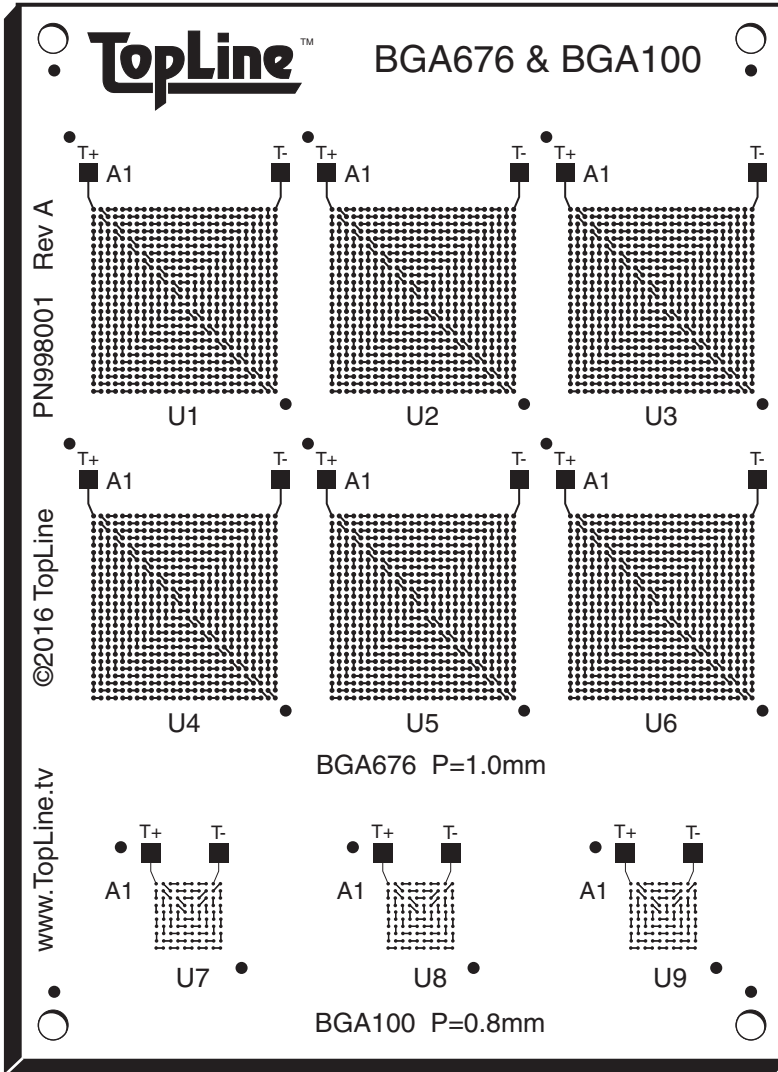

TopLine makes practicing with Fine Pitch Ball Grid Array technology accessible and affordable. Each board supports BGAs with 0.8mm and 1.0mm grid patterns and daisy chain test points to verify proper placement.

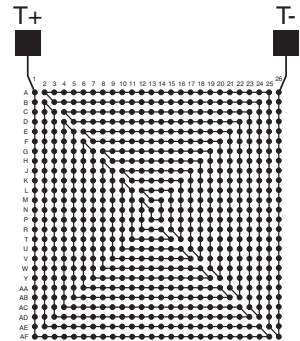

BGA676
AFTER ASSEMBLY

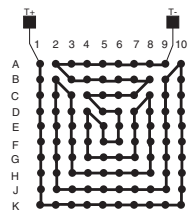

BGA100
AFTER ASSEMBLY

FEATURES

- LPI Solder Mask
- FR4 Board .062"
- Single Sided
- Tooling Holes .125"
- Fiducial Marks



Actual Size 4" x 5.5 (100 x 140mm)



FINE PITCH BGA WITH DAISY CHAIN TEST 0.8MM - 1.0MM PITCH



KIT ORDERING INFORMATION

COMPONENT	PITCH	 MANUAL ASSEMBLY		 MACHINE RUN		
		ORDER NUMBER 998900 1 KIT	ORDER NUMBER 998906 6 KITS	ORDER NUMBER 998910 10 KITS	ORDER NUMBER 998925 25 KITS	ORDER NUMBER 998950 50 KITS
Board		1	6	10	25	50
BGA100	0.8mm	3	18	30	75	150
BGA676	1.0mm	3	18	30	75	150

Kits are supplied with only 2 BGAs for each daisy chain portion of PC Board.

SOLDERMASK DEFINED PADS

Pitch	Pad Dia.	Ball Dia.
0.8mm	0.38mm	0.46mm
1.0mm	0.508mm	0.63mm

Lead Free (Pb-Free) Option

Description	Spare Board	1 Kit	6 Kits	10 Kits	25 Kits	500 Kits
Lead Free						
Sn – Tin	998002	998200	998206	998210	998225	998250
Ag – Silver	998006	998600	998606	998610	998625	998650
Cu – OSP	998008	998800	998806	998810	998825	998850
Au – Gold	998009	998900	998906	998910	998925	998950
Standard						
SnPb – HASL	998001	998300	998306	998310	998325	998350

Free Solder Paste Gerber + Parts Placement download www.topline.tv/GerbbersFree.cfm

TopLine[®]



BGA256 DAISY CHAIN KIT 1.0MM PITCH

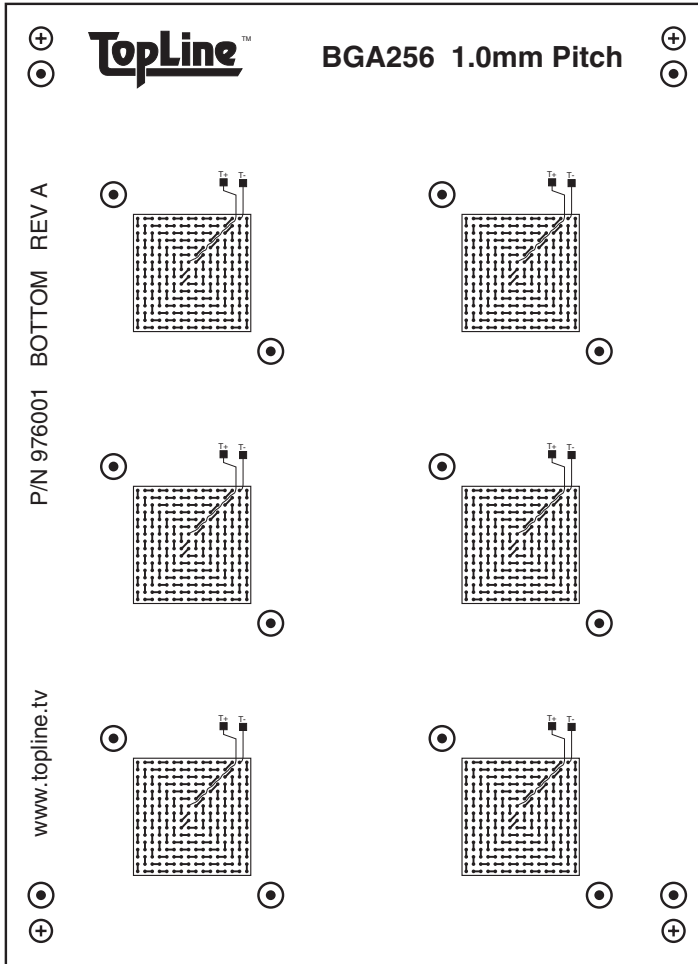

Actual Size: 4" x 5.5" (100 x 140mm)

Test board for 1.0mm pitch BGA256
Full Array with daisy chain.

Bottom side of board is for SBGA560
(not shown).

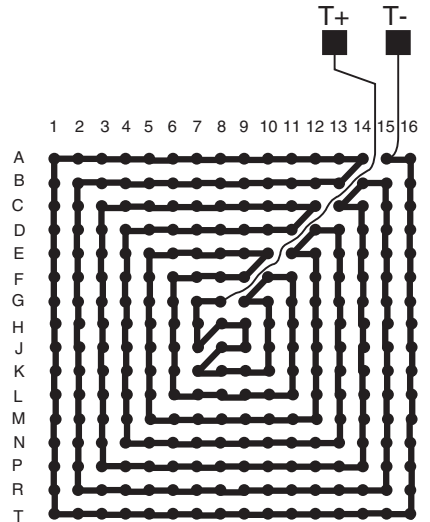

BGA256T1.0-DC169A
AFTER MOUNTING

FEATURES



- LPI Solder Mask
- Single Sided
- Tooling Holes .125"
- Fiducial Marks



BGA256 DAISY CHAIN KIT 1.0MM PITCH



KIT ORDERING INFORMATION

COMPONENT	BALL PITCH	 MANUAL ASSEMBLY		 MACHINE RUN		
		ORDER NUMBER	ORDER NUMBER	ORDER NUMBER	ORDER NUMBER	ORDER NUMBER
		976000 1 KIT	976010 10 KITS	976025 25 KITS	976050 50 KITS	976100 100 KITS
Board		1	10	25	50	100
BGA256	1.0mm	6	60	150	300	600

Kits are supplied with BGAs for one side of PC Board.

SOLDERMASK DEFINED PADS

Component	Pitch	Pad Dia.	Ball Dia.
BGA256	1.0mm	0.63mm	0.6mm

Lead Free (Pb-Free) Option

Description	Spare Board	1 Kit	10 Kits	25 Kits	50 Kits	100 Kits
Lead Free						
Sn – Tin	976002	976200	976210	976225	976250	976299
Ag – Silver	976006	976600	976610	976625	976650	976699
Cu – OSP	976008	976800	976810	976825	976850	976899
Au – Gold	976009	976900	976910	976925	976950	976999
Standard						
SnPb – HASL	976001	976002	976010	976025	976050	976100

Free Solder Paste Gerber + Parts Placement download www.topline.tv/GerbbersFree.cfm



BGA1600/1936 DAISY CHAIN KIT 1.0MM PITCH

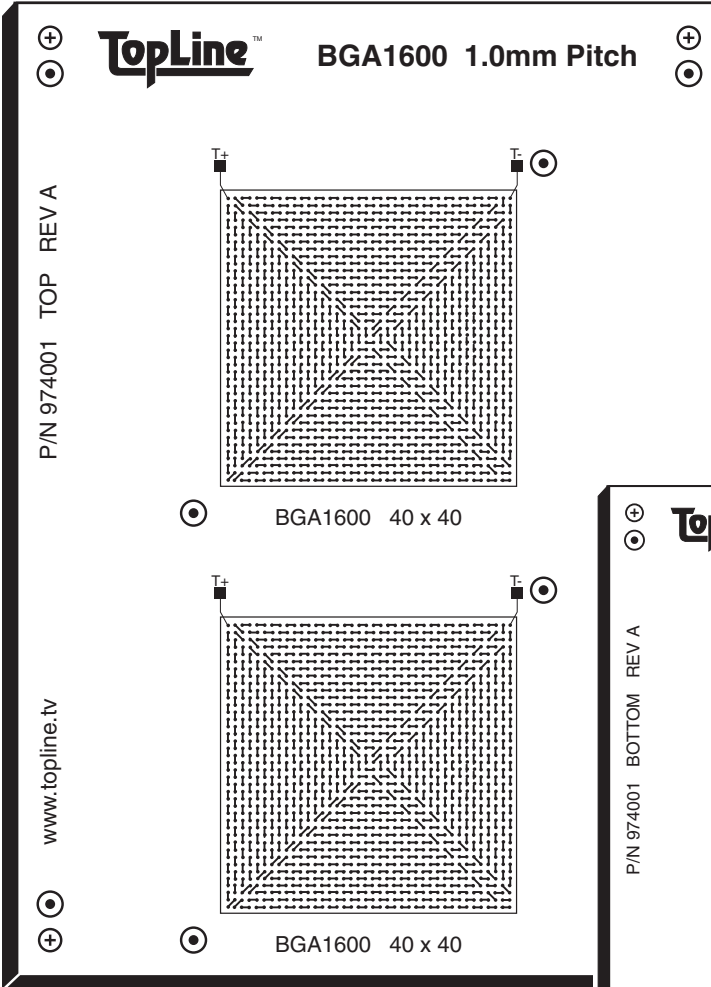

TOP SIDE BOARD

BOTTOM SIDE BOARD

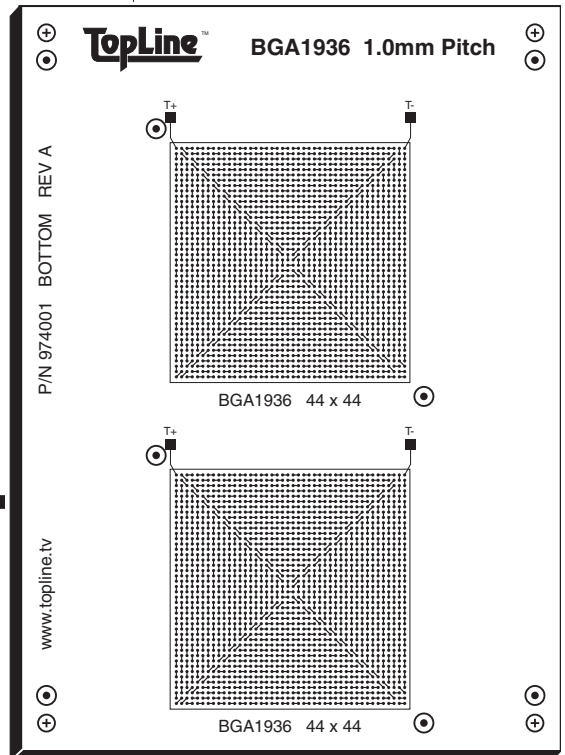

Actual Size: 4" x 5.5" (100 x 140mm)



TopLine®



BGA1600/1936 DAISY CHAIN KIT 1.0MM PITCH



KIT ORDERING INFORMATION

CONTENTS	 MANUAL ASSEMBLY			OR	 MACHINE RUN		
	ORDER NUMBER	ORDER NUMBER	ORDER NUMBER	ORDER NUMBER	ORDER NUMBER	ORDER NUMBER	
	974000	974600	974900	974021	974621	974921	
	1 KIT	1 KIT	1 KIT	1 KIT	1 KIT	1 KIT	
	Sn Pb BALLS			LEAD FREE SnAgCu BALLS			
BGA1600	2	2	0	2	2	0	
BGA1936	2	0	2	2	0	2	
Board Sn-Tin	1	1	1	1	1	1	

Select the kit that matches your requirements

SOLDERMASK DEFINED PADS

Component	Pitch	Pad Dia.	Ball Dia.
BGA1600/1936	1.0mm	0.635mm	0.6mm

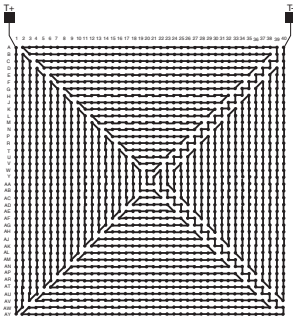

BGA1600T1.0-DC409
After Mounting

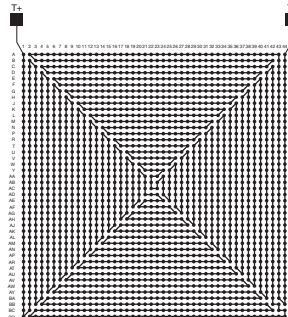

BGA1936T1.0-DC449
After Mounting

OPTIONAL ACCESSORIES

PARTS PLACEMENT DATA	BOARD ORDER NUMBER
X, Y, THETA ASCII FILE	Sn - Tin 974002
ORDER NUMBER 974004	Ag - Silver 974006
SOLDER PASTE ARTWORK	Cu - OSP 974008
GERBER FILE	Au - Gold 974009
ORDER NUMBER 974005	



UNIVERSAL BGA DAISY CHAIN KIT 1.0/1.27MM PITCH



TOP SIDE
BOARD

BOTTOM SIDE
BOARD

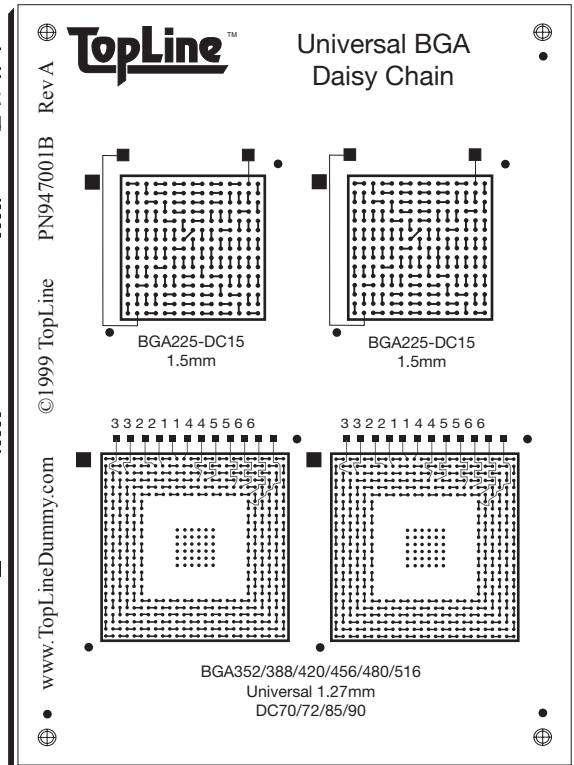
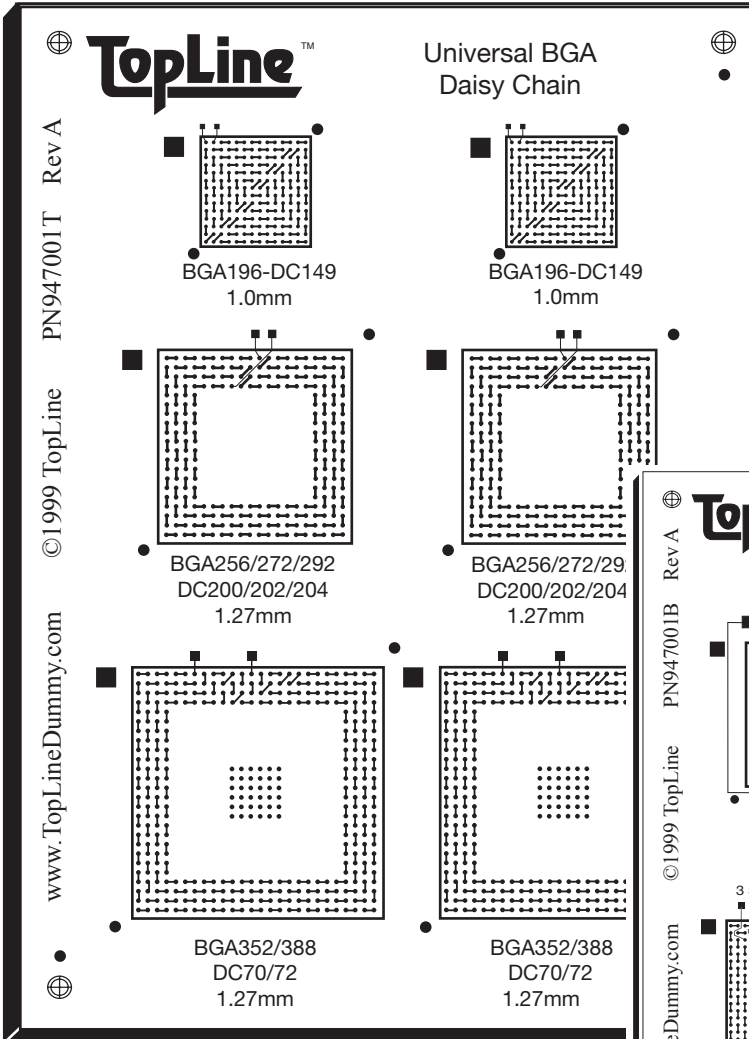



Actual Size: 4" x 5.5" (100 x 140mm)



UNIVERSAL BGA DAISY CHAIN KIT 1.0/1.27MM PITCH



KIT ORDERING INFORMATION

COMPONENT	PITCH	 MANUAL ASSEMBLY		 MACHINE RUN		
		ORDER NUMBER 947000 1 KIT	ORDER NUMBER 947010 10 KITS	ORDER NUMBER 947025 25 KITS	ORDER NUMBER 947050 50 KITS	ORDER NUMBER 947100 100 KITS
Board		1	10	25	50	100
BGA196	1.0mm	2	20	50	100	200
BGA256	1.27mm	2	20	50	100	200
BGA352	1.27mm	2	20	50	100	200

Kits are supplied with BGAs for top side of PC Board.

SOLDERMASK DEFINED PADS

Component	Pitch	Pad Dia.	Ball Dia.
BGA196	1.0mm	0.508mm	0.63mm
others	1.27~1.5mm	0.61mm	0.75mm

Lead Free (Pb-Free) Option

Description	Spare Board	1 Kit	10 Kits	25 Kits	50 Kits	100 Kits
Lead Free						
Sn – Tin	947002	947200	947210	947225	947250	947299
Ag – Silver	947006	947600	947610	947625	947650	947699
Cu – OSP	947008	947800	947810	947825	947850	947899
Au – Gold	947009	947900	947910	947925	947950	947999
Standard						
SnPb – HASL	947001	947000	947010	947025	947050	947100

Free Solder Paste Gerber + Parts Placement download www.topline.tv/GerbbersFree.cfm

TopLine[®]

BGA256/BGA272 1.27MM PITCH

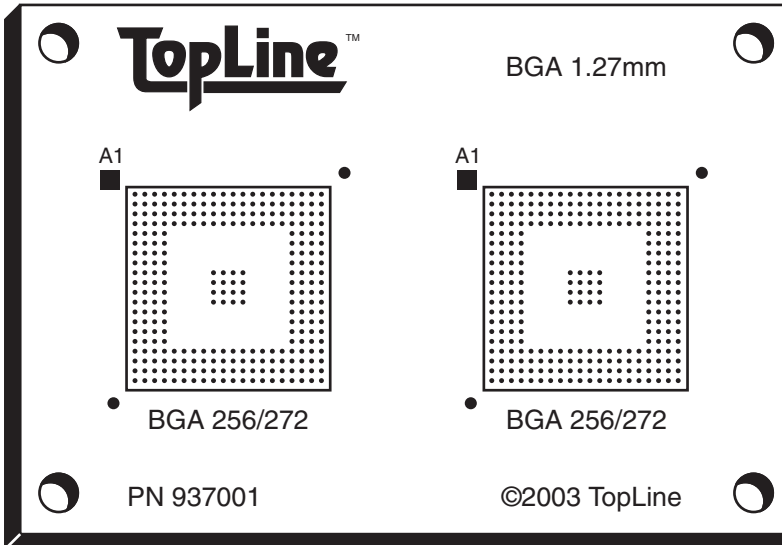

TopLine offers a low cost BGA kit for placement and rework practice. Popular BGA256/BGA272 without daisy chain. Use for hand solder or machine assembly

FEATURES

- FR4 Board
- Double Sided
- Tooling Holes
- Fiducial Marks
- LPI Soldermask
- Pad Site .030" dia.

Actual Size 2.75" x 4.0" (70 x 100mm)



TopLine®



BGA256/BGA272 1.27MM PITCH



KIT ORDERING INFORMATION

COMPONENT SELECTION	BALL PITCH	MANUAL ASSEMBLY OR  MACHINE RUN				
		 937000	937010	937020	937040	937080
		ORDER NUMBER 1 KIT	ORDER NUMBER 10 KITS	ORDER NUMBER 20 KITS	ORDER NUMBER 40 KITS	ORDER NUMBER 80 KITS
Board		1	10	20	40	80
BGA256/BGA272	1.27mm	2	20	40	80	160

Lead Free (Pb-Free) Option

Description	Spare Board	1 Kit	10 Kits	20 Kits	40 Kits	80 Kits
Lead Free						
Sn – Tin	937002	937200	937210	937220	937240	937280
Ag – Silver	937006	937600	937610	937620	937640	937680
Cu – OSP	937008	937800	937810	937820	937840	937880
Au – Gold	937009	937900	937910	937920	937940	937980
Standard						
SnPb – HASL	937001	937000	937010	937020	937040	937080

Free Solder Paste Gerber + Parts Placement download www.topline.tv/GerbbersFree.cfm

TopLine[®]



BGA169 & BGA225 WITH DAISY CHAIN TEST 1.5MM PITCH

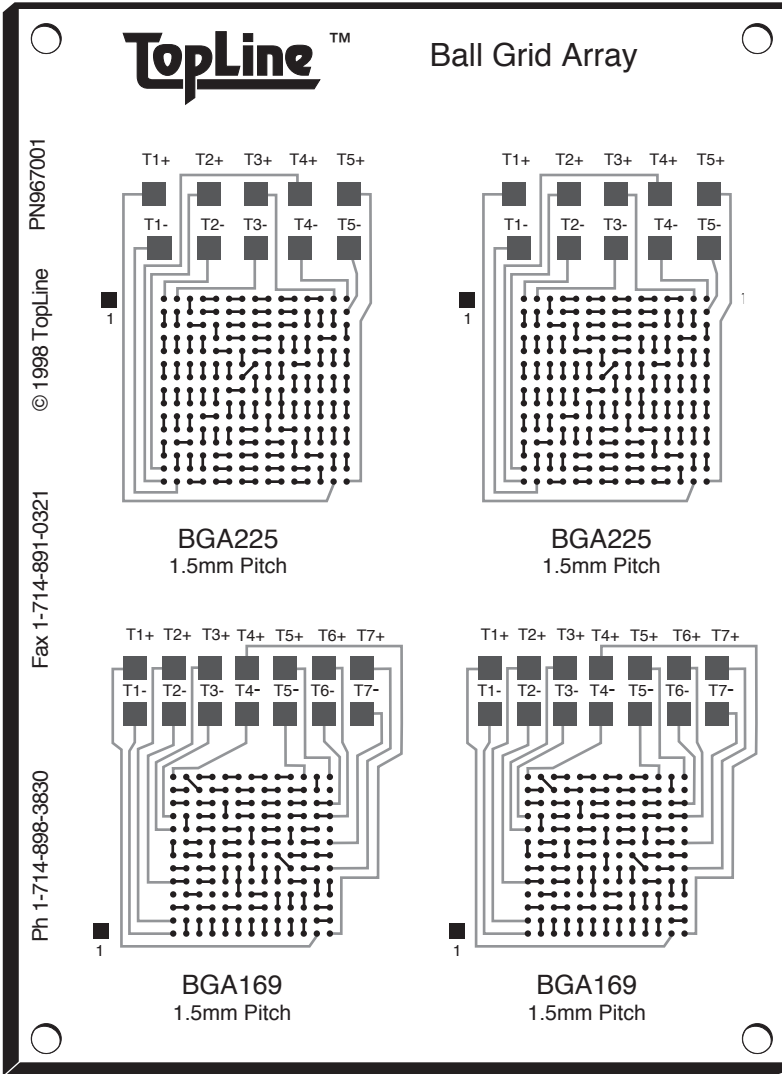

TopLine makes practicing with Ball Grid Array technology accessible and affordable. Each board supports four BGAs with 1.5mm grid pattern and daisy chain test points to verify proper placement. Double sided board incorporates "two front side" design so only one solder paste stencil is needed.

FEATURES

- LPI Solder Mask
- FR4 Board .062"
- Double Sided
- Tooling Holes .125"
- Fiducial Marks



Actual Size 4" x 5.5 (100 x 140mm)



BGA169 & BGA225 WITH DAISY CHAIN TEST 1.5MM PITCH



KIT ORDERING INFORMATION

COMPONENT	PITCH	 MANUAL ASSEMBLY	 MACHINE RUN			
		ORDER NUMBER 967000 1 KIT	ORDER NUMBER 967012 12 KITS	ORDER NUMBER 967025 25 KITS	ORDER NUMBER 967050 50 KITS	ORDER NUMBER 967100 100 KITS
Board		1	12	25	50	100
BGA 169	1.5mm	2	25	50	100	200
BGA 225	1.5mm	2	25	50	100	200

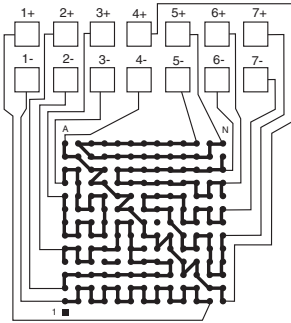

BGA169
AFTER MOUNTING TO TEST BOARD

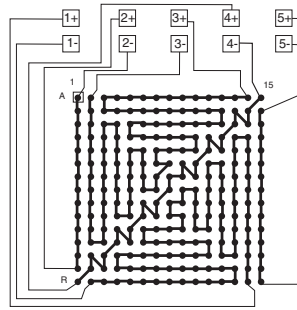

BGA225
AFTER MOUNTING TO TEST BOARD

Lead Free (Pb-Free) Option

Description	Spare Board	1 Kit	12 Kits	25 Kits	50 Kits	100 Kits
Lead Free						
Sn – Tin	967002	967200	967212	967225	967250	967299
Ag – Silver	967006	967600	967612	967625	967650	967699
Cu – OSP	967008	967800	967812	967825	967850	967899
Au – Gold	967009	967900	967912	967925	967950	967999
Standard						
SnPb – HASL	967001	967000	967012	967025	967050	967100

Free Solder Paste Gerber + Parts Placement download www.topline.tv/GerbbersFree.cfm



UNIVERSAL BGA KIT 1.27MM & 1.5MM PITCH



TopLine's Universal BGA Kits are economical. Includes non-daisy-chain BGA components. Kit has 1.27mm and 1.5mm pitch for placement and solder practice.

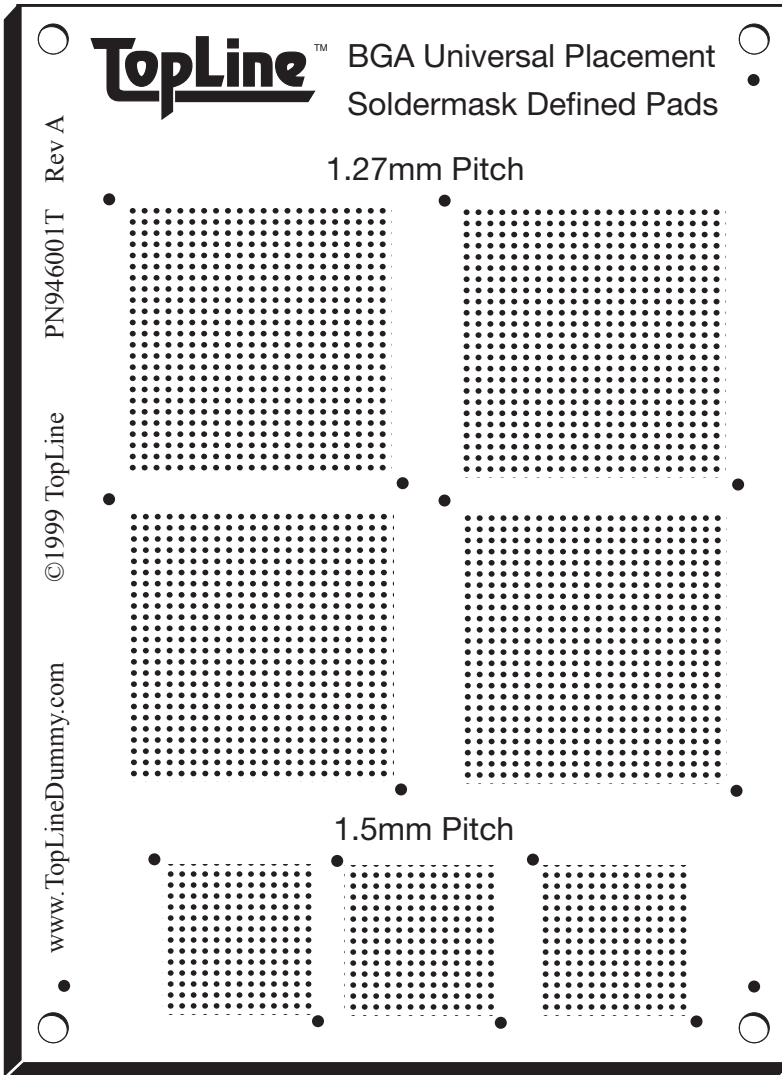

Top Side-
Soldermask defined pads

Bottom Side-
Etched defined pads

FEATURES

- LPI Solder Mask
- FR4 Board .062"
- Double Sided
- Tooling Holes

Actual Size: 4" x 5.5" (100 x 140mm)



TopLine®



UNIVERSAL BGA KIT 1.27MM & 1.5MM PITCH



KIT ORDERING INFORMATION

		 MANUAL ASSEMBLY	 MACHINE RUN	
		ORDER NUMBER 946000 1 KIT	ORDER NUMBER 946010 10 KITS	ORDER NUMBER 946025 25 KITS
COMPONENT	PITCH			
Board 946001	1.27/1.5mm	1	10	25
BGA169 or BGA225	1.5mm	4	40	100
BGA256 or BGA352	1.27mm	4	40	100

Lead Free (Pb-Free) Option

Description	Spare Board	1 Kit	10 Kits	25 Kits	50 Kits	100 Kits
Lead Free						
Sn – Tin	946002	946200	946210	946225	946250	946299
Ag – Silver	946006	946600	946610	946625	946650	946699
Cu – OSP	946008	946800	946810	946825	946850	946899
Au – Gold	946009	946900	946910	946925	946950	946999
Standard						
SnPb – HASL	946001	946000	946010	946025	946050	946100

Free Solder Paste Gerber + Parts Placement download www.topline.tv/GerbersFree.cfm

TopLine[®]



LBGA1225 DAISY CHAIN KIT 1.27MM PITCH

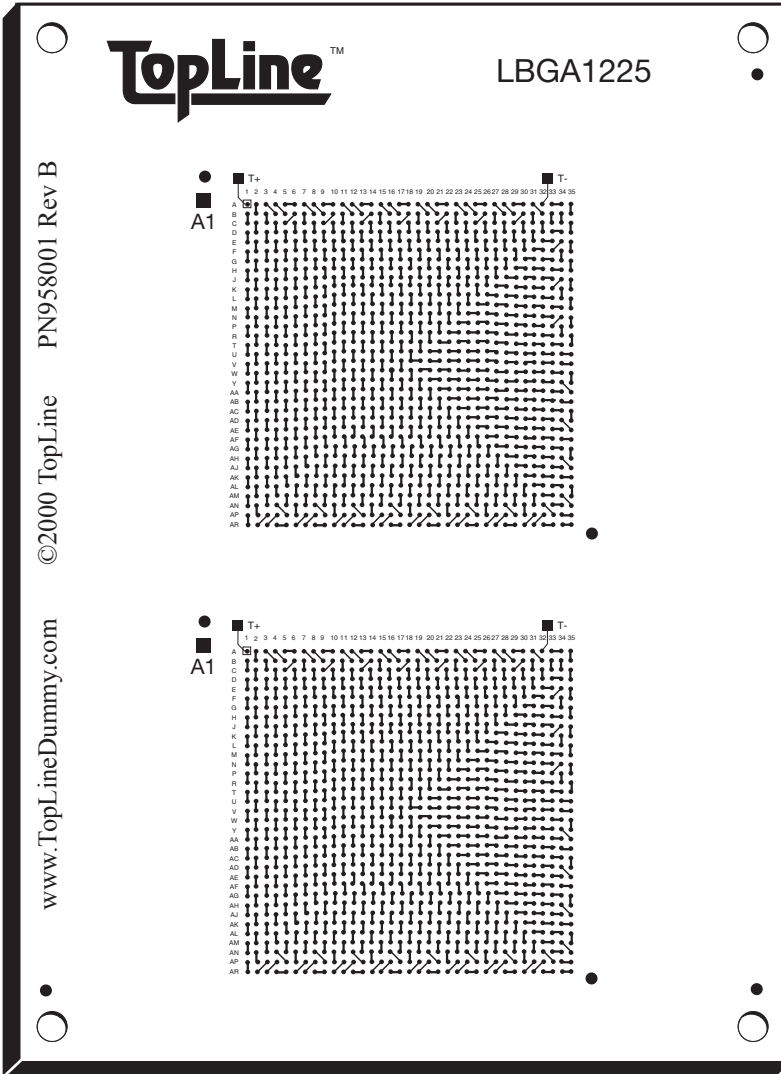

Experiment with large size Ball Grid Arrays. Kit comes consists of PC Board with daisy chain and matching 45mm square LBGA Component with 1225 solder balls.

Top Side:
35 x 35 matrix LPGA1225

Bottom Side: LPGA1089
33 x 33 matrix: Not Shown

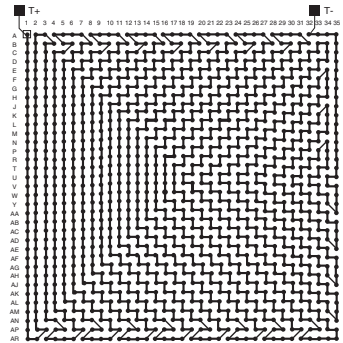

**LBGA1225-DC359
After Mounting**

Soldermask defined
pad diameter 0.6mm

FEATURES

- LPI Solder Mask
- FR4 Board .062"
- Double Sided
- Tooling Holes
- Fiducial Marks

Actual Size: 4" x 5.5" (100 x 140mm)



TopLine[®]



LPGA1225 DAISY CHAIN KIT 1.27MM PITCH



KIT ORDERING INFORMATION

		 MANUAL ASSEMBLY	 MACHINE RUN	
		ORDER NUMBER 958000 1 KIT	ORDER NUMBER 958012 12 KITS	ORDER NUMBER 958024 24 KITS
COMPONENT	PITCH			
Board 958001 LPGA1225	1.27mm	1 2	12 24	24 48

Lead Free (Pb-Free) Option

Description	Spare Board	1 Kit	10 Kits	25 Kits	50 Kits	100 Kits
Lead Free						
Sn – Tin	958002	958200	958210	958225	958250	958299
Ag – Silver	958007	958600	958610	958625	958650	958699
Cu – OSP	958008	958800	958810	958825	958850	958899
Au – Gold	958009	958900	958910	958925	958950	958999
Standard						
SnPb – HASL	958001	958000	958010	958025	958050	958100

Free Solder Paste Gerber + Parts Placement download www.topline.tv/GerbbersFree.cfm

TopLine[®]

CERAMIC CBGA KIT 1.27MM PITCH



Rev B
PN951001T

©1999 TopLine

www.TopLineDummy.com

TopLine[™]

Ceramic CBGA

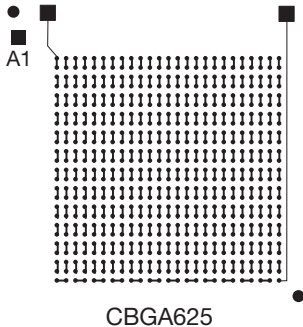
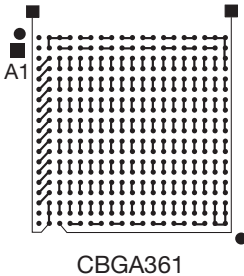
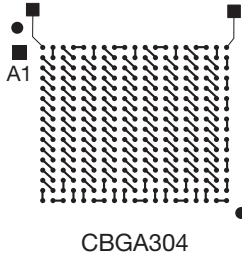
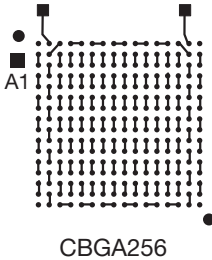
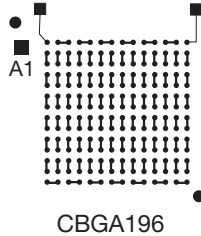
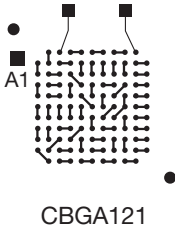

TopLine's Ceramic Ball Grid Array. Kit includes one PC board and 6-different CBGAs. New Rev "B" design is daisy chain, double sided with same land patterns on both sides of board.

FEATURES

- LPI Solder Mask
- FR4 Board .062"
- Double Sided
- Tooling Holes .125"
- Fiducial Marks

Actual Size: 4" x 5.5" (100 x 140mm)





CERAMIC CBGA KIT

1.27MM PITCH



KIT ORDERING INFORMATION

COMPONENT	PITCH	 MANUAL ASSEMBLY		 MACHINE RUN	
		ORDER NUMBER 951000 1 KIT	ORDER NUMBER 951010 10 KITS	ORDER NUMBER 951012 12 KITS	ORDER NUMBER 951025 25 KITS
Board		1	10	12	25
CBGA121 11 x 11	1.27mm	1	10	12	25
CBGA196 14 x 14	1.27mm	1	10	12	25
CBGA256 16 x 16	1.27mm	1	10	12	25
CBGA304 21 x 25	1.27mm	1	10	12	25
CBGA361 19 x 19	1.27mm	1	10	12	25
CBGA625 25 x 25	1.27mm	1	10	12	25

Lead Free (Pb-Free) Option

Description	Spare Board	1 Kit	10 Kits	12 Kits	25 Kits
Lead Free					
Sn – Tin	951002	951200	951210	951212	951225
Ag – Silver	951006	951600	951610	951612	951625
Cu – OSP	951008	951800	951810	951812	951825
Au – Gold	951009	951900	951910	951912	951925
Standard					
SnPb – HASL	951001	951000	951010	951012	951025

Free Solder Paste Gerber + Parts Placement download www.topline.tv/GerbersFree.cfm



Practice Lead free assembly using fine-pitch components.

BGA196-DC149
1.0mm

BGA256/272/292
DC200/202/204
1.27mm

0402

0603

0805

1206

BGA225
1.5mm

QFP208 .5mm

PC BOARD FEATURES

- LPI Solder Mask
- FR4 Board .062"
- Double Sided
- Tooling Holes .125"
- Fiducial Marks

ASSEMBLY METHODS

- Machine Run
- Hand Solder
- Rework

© 1999 TopLine PN986001 Rev A

www.TopLineDummy.com



Actual Size 4" x 5.5 (100 x 140mm)



LEAD FREE KIT MULTICOMPONENTS



KIT ORDERING INFORMATION

COMPONENT	PITCH	 MANUAL ASSEMBLY		 MACHINE RUN		
		ORDER NUMBER	ORDER NUMBER	ORDER NUMBER	ORDER NUMBER	ORDER NUMBER
		986000	986010	986024	986050	986100
		1 KIT	10 KITS	24 KITS	50 KITS	100 KITS
Board		1	10	24	50	100
BGA196	1.0mm	1	10	24	50	100
BGA225	1.5mm	1	10	24	50	100
BGA256	1.27mm	1	10	24	50	100
QFP208	0.5mm	1	10	24	50	100
0402		10	100	250	500	1000
0603		10	100	250	500	1000
0805		10	100	250	500	1000
1206		10	100	250	500	1000

Lead Free (Pb-Free) Option

Description	Spare Board	1 Kit	10 Kits	24 Kits	50 Kits	100 Kits
Lead Free						
Sn - Tin	986002	986200	986210	986224	986250	986299
Ag - Silver	986006	986600	986610	986624	986650	986699
Cu - OSP	986008	986800	986810	986824	986850	986899
Au - Gold	986009	986900	986910	986924	986950	986999

Free Solder Paste Gerber + Parts Placement download www.topline.tv/GerbersFree.cfm



LARGE MACHINE RUN KIT

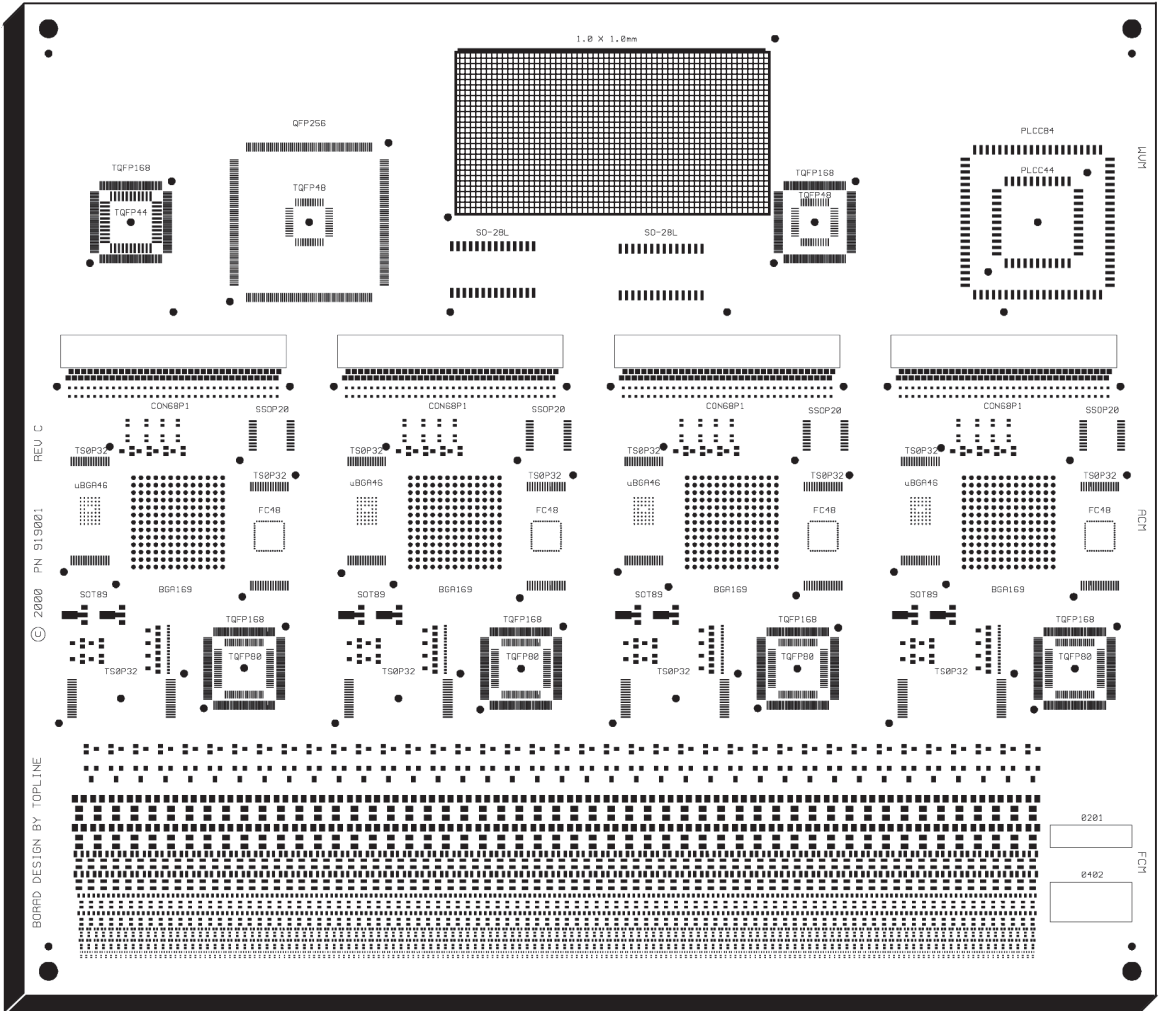

Actual Size: 9" x 7.875" (228.6mm x 200mm)

FEATURES

- Single Sided
- Black LPI Soldermask
- Very High Density
- 0201 Chips



KIT ORDERING INFORMATION

	PER BOARD	PITCH				
			ORDER NUMBER 919010 10 KIT	ORDER NUMBER 919025 25 KITS	ORDER NUMBER 919050 50 KITS	ORDER NUMBER 919100 100 KITS
COMPONENT						
Board			10	25	50	100
LQFP168	6	0.3mm	0	0	0	0
QFP256	1	0.4mm	10	24	48	96
TQFP48	2	0.5mm	25	50	100	200
TQFP44	1	0.8mm	10	25	50	100
LQFP80	4	0.4mm	40	100	200	400
TSOP32	12	0.5mm	120	300	600	1,200
FLIP CHIP 48	4	457µm	0	0	0	0
µBGA46	4	0.75mm	40	100	200	400
BGA169	4	1.5mm	40	100	180	360
PLCC44	1	1.27mm	10	25	50	100
PLCC84	1	1.27mm	10	25	50	100
SOL28	2	1.27mm	20	50	100	200
SSOP20	4	0.65mm	40	100	200	400
SOT323	87		3,000	3,000	3,000	6,000
SOT23	39		3,000	3,000	3,000	6,000
SOT89	8		100	200	400	800
0201	600		5,000	15,000	30,000	60,000
0402	700		10,000	20,000	40,000	80,000
0603	500		5,000	15,000	25,000	50,000
0805	300		5,000	10,000	15,000	30,000
1206	200		5,000	10,000	15,000	20,000

Lead Free (Pb-Free) Option

Description	Spare Board	10 Kits	25 Kits	50 Kits	100 Kits
Lead Free					
Sn – Tin	919002	919210	919225	919250	919299
Ag – Silver	919006	919610	919625	919650	919699
Cu – OSP	919008	919810	919825	919850	919899
Au – Gold	919009	919910	919925	919950	919999
Standard					
SnPb – HASL	919001	919010	919025	919050	919100

Free Solder Paste Gerber + Parts Placement download www.topline.tv/GerbbersFree.cfm

TopLine®



CHALLENGER 2 KIT INTERMEDIATE SMD



PN928001

© 1998 TopLine

Fax 1-714-891-0321

Ph 1-714-898-3830

Challenger 2

QFP44 - .8mm

0805

1206

1210

Inductor

0603

5020 Crystal

MINI MELF

1812

0402

Tantalum

SO 14

SOM 16

PLCC 20

SOL 20

SOT 23

SOT 89

SOT323

MELF

AL CAP
6.3mm

AL CAP
4mm

SOT 223

Pot.

D PAK

BGA169

TSOP32-T1

PLCC 68

QFP100 .65mm

QFP208 .5mm

The new Challenger 2 Kit gives you a wide selection of 33 different SMD packages. Includes BGA with daisy chain continuity test, fine-pitch components and many discrete components. Double-sided board incorporates "two-front-side" design so only one solder paste stencil is needed. Put your machine to the test with the new Challenger 2 Kit.

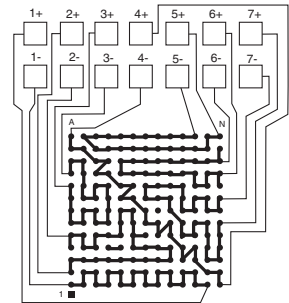

BGA169 AFTER MOUNTING

FEATURES

- LPI Solder Mask
- FR4 Board .062"
- Double Sided
- Tooling Holes .125"
- Fiducial Marks

Actual Size: 4" x 5.5" (100 x 140mm)



KIT ORDERING INFORMATION

 COMPONENT	PITCH	 MANUAL ASSEMBLY		 MACHINE RUN		
		ORDER NUMBER	ORDER NUMBER	ORDER NUMBER	ORDER NUMBER	ORDER NUMBER
		928000	928010	928025	928050	928100
		1 KIT	10 KITS	25 KITS	50 KITS	100 KITS
Board		1	10	25	50	100
TSOP32	0.5mm	1	10	25	50	100
QFP208	0.5mm	1	10	25	50	100
QFP100	0.65mm	1	10	25	50	100
QFP44	0.8mm	1	10	25	50	100
PLCC20	1.27mm	1	10	25	50	100
PLCC68	1.27mm	1	10	25	50	100
SO14	1.27mm	1	10	25	50	100
SOM16	1.27mm	1	10	25	50	100
SOL20	1.27mm	1	10	25	50	100
BGA169	1.5mm	1	10	25	50	100
SOT23		3	30	75	150	400
SOT89		2	20	50	100	200
SOT223		1	10	25	50	100
SOT323		2	20	50	100	200
DKPAK		1	10	25	100	100
Crystal		1	10	25	100	100
Tantalum A & B		1 ea.	10 ea.	25 ea.	50 ea.	100 ea.
Tantalum C & D		1 ea.	10 ea.	25 ea.	100 ea.	100 ea.
Aluminum Cap 4mm & 6.3mm		1 ea.	10 ea.	25 ea.	100 ea.	100 ea.
0402 & 0603 Chip		10 ea.	100 ea.	250 ea.	500 ea.	1000 ea.
0805 & 1206 Chip		10 ea.	100	150	500	1000
1206 mini MELF		6	60	150	500	500
1210 Chip		6	60	25	50	250
1210 Inductor		1	10	25	50	100
1812 Chip		1	10	25	50	100
1812 Inductor		1	10	25	50	100
Potentiometer		1	10	25	50	100
2308 MELF		2	20	50	100	200

Lead Free (Pb-Free) Option

Description	Spare Board	1 Kit	10 Kits	25 Kits	50 Kits	100 Kits
Lead Free						
Sn – Tin	928002	928200	928210	928225	928250	928299
Ag – Silver	928006	928600	928610	928625	928650	928699
Cu – OSP	928008	928800	928810	928825	928850	928899
Au – Gold	928009	928900	928910	928925	928950	928999
Standard						
SnPb – HASL	928001	928000	928010	928025	928050	928100

Free Solder Paste Gerber + Parts Placement download www.topline.tv/GerbbersFree.cfm

TopLine[®]



SABER 4-BOARD ARRAY

ADVANCED MIXED TECHNOLOGY

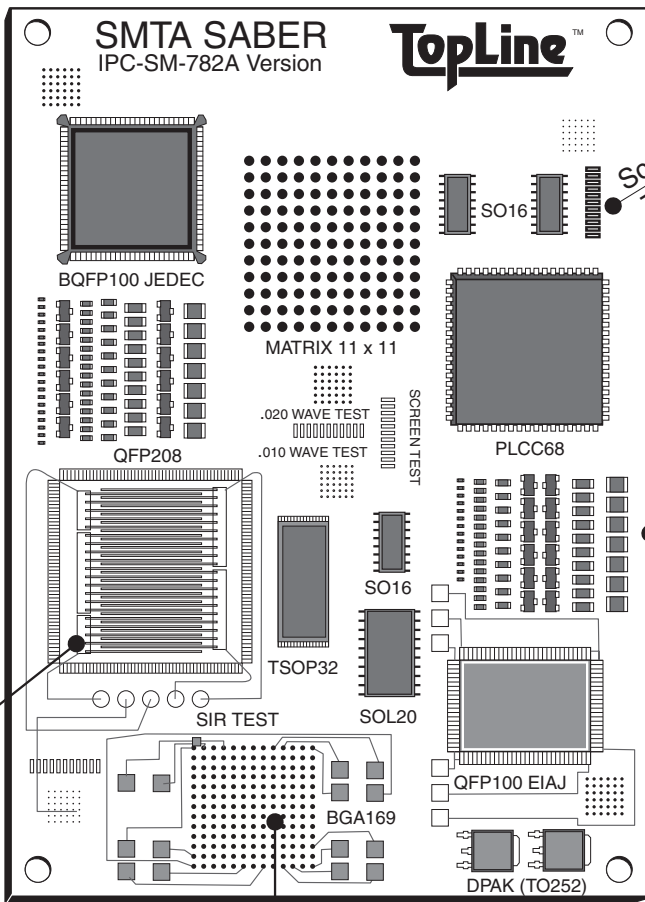

The SABER Board has helped many SMTA members to define and refine their surface mount assembly processes. The SABER Board is used by mainstream surface mount manufacturers throughout the industry to test capabilities such as component placement accuracy, cleanliness (SIR-surface insulation resistance), solder paste screening, solder joint integrity, wave soldering and component placement speed (chip shooting). The SABER Board is supplied as a snap-apart, four board panelized array.

0402/1210
Chips & SOT's

ACTUAL PANEL SIZE:
8" x 11" (200 x 280mm)

SIR Test*

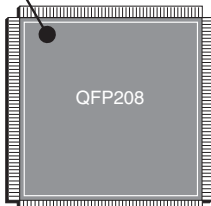

Daisy Chain



102

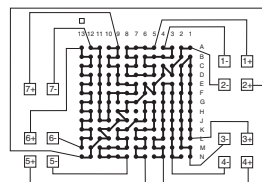

BGA AFTER MOUNTING (TOP SIDE)

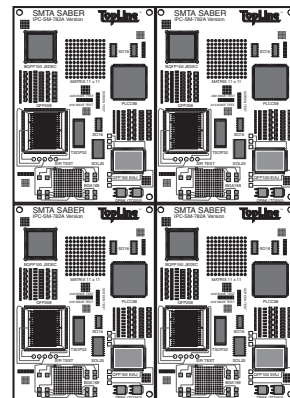

FEATURES

- LPI Solder
- FR4 Board .062"
- Double Sided
- Tooling Holes .125"
- Fiducial Marks
- 4-Board Routed Array



KIT ORDERING INFORMATION

*BQFP100 only in SnPb Kit

COMPONENT	PITCH	MANUAL ASSEMBLY		MACHINE RUN		
		ORDER NUMBER 950000 4 KITS	ORDER NUMBER 950012 12 KITS	ORDER NUMBER 950024 24 KITS	ORDER NUMBER 950048 48 KITS	ORDER NUMBER 950096 96 KITS
SABER Array		1 Array	3 Arrays	6 Arrays	12 Arrays	24 Arrays
QFP208	0.5mm	4	12	25	50	100
TSOP32	0.5mm	4	12	25	50	100
QFP100	0.65mm	4	12	25	50	100
BQFP100*	25mil	4	12	25	50	100
BGA169	1.5mm	4	12	25	50	100
PLCC68	1.27mm	4	12	25	50	100
SO16	1.27mm	12	50	100	200	300
SOL20	1.27mm	4	12	50	50	100
DPAK	1.27mm	10	25	50	100	200
SOT23	1.27mm	100	300	500	1000	3000
0402/0603/0805/1206 Chip	-	100	500	1000	2000	5000
1210 Chip	-	100	200	500	1000	1000
DIP14 ~ 20	100mil	8	25	50	100	200

Lead Free (Pb-Free) Option

Description	Spare Board	1 Kit	10/12 Kits	24/25 Kits	48/50 Kits	96/100 Kits
4-Board Array						
Sn – Tin	950002	950200	950212	950224	950248	950296
Ag – Silver	950006	950600	950612	950624	950648	950696
Cu – OSP	950008	950800	950812	950824	950848	950896
Au – Gold	950009	950900	950912	950924	950948	950996
Standard						
SnPb – HASL	950001	950000	950012	950024	950048	950096
Single (1-up)						
Sn – Tin	950013	950201	950210	950225	950250	950299
Ag – Silver	950016	950601	950610	950625	950650	950699
Cu – OSP	950018	950801	950810	950825	950850	950899
Au – Gold	950007	950901	950910	950925	950950	950999
Standard						
SnPb – HASL	950003	950011	950010	950025	950050	950100



PN935001

© 1998 TopLine

Fax 1-714-891-0321

Ph 1-714-898-3830

TopLine™ Stencil Evaluation Kit

DAISY CHAIN

T1+ T2+ T3+ T4+ T5+
T1- T2- T3- T4- T5-

QFP 256 .4mm

TSOP32 .5mm

QFP 208 .5mm

MINI MELF

BGA225 1.5mm Pitch

QFP100 .65mm

D PAK

0402

0603

SOL 20

PLCC 44

SCREEN TEST PATTERN

We supply the board and components. You provide the stencil. All kits include a ball grid array with daisy chain test and 0.4mm pitch QFP256.

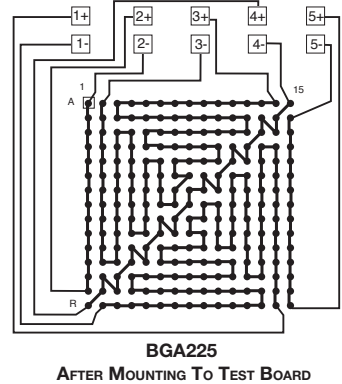



- FEATURES**
- LPI Solder Mask
 - FR4 Board .062"
 - Double Sided
 - Tooling Holes .125"
 - Fiducial Marks

Actual Size: 4" x 5.5" (100 x 140mm)



KIT ORDERING INFORMATION

COMPONENT	PITCH	 MANUAL ASSEMBLY		 MACHINE RUN		
		ORDER NUMBER 936000 1 KIT	ORDER NUMBER 936010 10 KIT	ORDER NUMBER 936025 25 KITS	ORDER NUMBER 936050 50 KITS	ORDER NUMBER 936100 100 KITS
Board		1	10	25	50	100
LQFP168	0.3mm	0	0	0	0	0
QFP256	0.4mm	1	10	25	50	100
QFP208	0.5mm	1	10	25	50	100
TSOP32	0.5mm	1	10	25	50	100
QFP100	0.65mm	1	10	25	50	100
BGA225	1.5mm	1	10	25	50	100
PLCC44	50mil	1	10	25	50	100
SOL20	50mil	1	10	25	50	100
DPAK		1	10	25	50	100
0402 chip		10	100	250	500	1000
0603 chip		10	100	250	500	1000
mini Melf		6	60	150	300	600

Lead Free (Pb-Free) Option

Description	Spare Board	1 Kit	10 Kits	25 Kits	50 Kits	100 Kits
Lead Free						
Sn - Tin	935002	936200	936210	936225	936250	936299
Ag - Silver	935006	936600	936610	936625	936650	936699
Cu - OSP	935008	936800	936810	936825	936850	936899
Au - Gold	935009	936900	936910	936925	936950	936999
Standard						
SnPb - HASL	935001	936000	936010	936025	936050	936100

Free Solder Paste Gerber + Parts Placement download www.topline.tv/GerbbersFree.cfm



REWORK 1 PRACTICE KIT



TopLine

PN 965001

© 1997 TopLine

Fax 1-714-891-0321

Ph 1-714-898-3830

Rework Practice

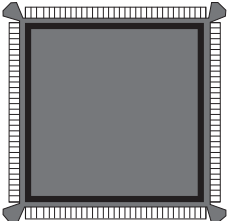

BQFP 132



SO 14



SO 14

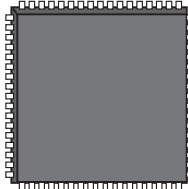

PLCC 68



0805 (2012)



TSOP 32



1206 (3216)

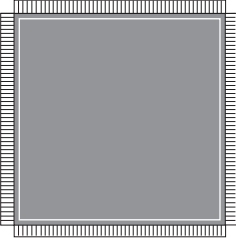

QFP 208

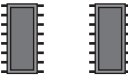

SOM 16

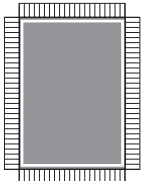

QFP100

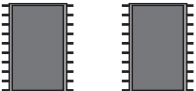

SOL 20



SOT 23

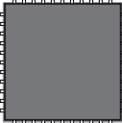

PLCC 44



PLCC 44



PLCC 20



PLCC 20

This Rework Practice Kit is designed for all skill levels. Includes fine-pitch components often found in real world rework situations.

FEATURES

- LPI Solder Mask
- FR4 Board .062"
- Double Sided
- Tooling Holes .125"
- Fiducial Marks



Actual Size: 4" x 5.5" (100 x 140mm)



REWORK 1 PRACTICE KIT



KIT ORDERING INFORMATION

COMPONENT	PITCH	 MANUAL ASSEMBLY		 MACHINE RUN		
		ORDER NUMBER 965000 1 KIT	ORDER NUMBER 965010 10 KITS	ORDER NUMBER 965026 25 KITS	ORDER NUMBER 965050 50 KITS	ORDER NUMBER 965100 100 KITS
Board		1	10	25	50	100
QFP208	0.5mm	1	10	25	50	100
TSOP32	0.5mm	1	10	25	50	100
QFP100	0.65mm	1	10	25	50	100
BQFP132*	25mils	1	10	25	50	100
PLCC20	50mils	2	25	50	100	200
PLCC44	50 mils	2	25	50	100	200
PLCC68	50mils	1	10	25	50	100
SO14	50mils	2	25	50	100	200
SOM16	50mils	2	25	50	100	200
SOL20	50mils	2	25	50	100	200
SOT23		10	100	500	500	500
0805 Chip		10	100	500	500	1000
1206 Chip		10	100	250	500	1000

*BQFP132 only in SnPb Kits

Lead Free (Pb-Free) Option

Description	Spare Board	1 Kit	10 Kits	25 Kits	50 Kits	100 Kits
Lead Free						
Sn - Tin	965002	965200	965210	965225	965250	965299
Ag - Silver	965006	965600	965610	965625	965650	965699
Cu - OSP	965008	965800	965810	965825	965850	965899
Au - Gold	965009	965900	965910	965925	965950	965999
Standard						
SnPb - HASL	965001	965000	965010	965025	965050	965100

Free Solder Paste Gerber + Parts Placement download www.topline.tv/GerbbersFree.cfm



REWORK 2 PRACTICE KIT

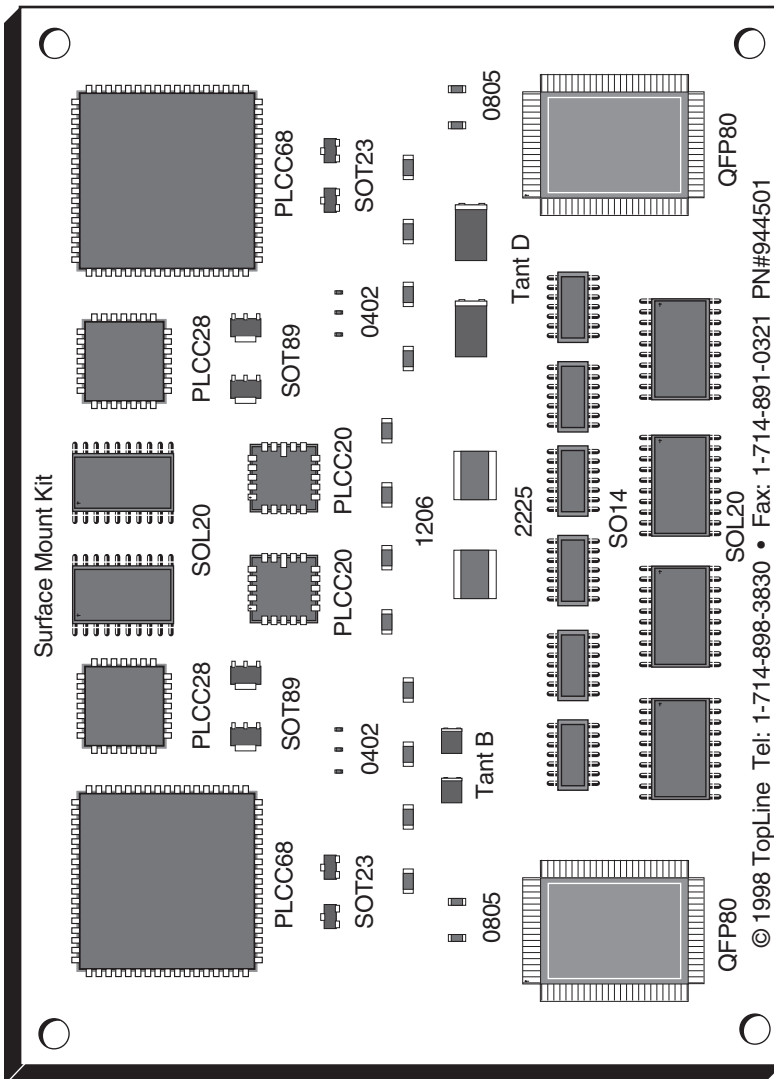

Topline provides this kit for rework practice. Kit contains popular components including fine pitch Quad Flat Pack. For manual assembly only.

FEATURES

- LPI Solder Mask
- FR4 Board .062"
- Double Sided
- Tooling Holes .125"
- Fiducial Marks

Actual Size: 4" x 5.5" (100 x 140mm)



REWORK 2 PRACTICE KIT



KIT ORDERING INFORMATION

COMPONENT	PITCH	MANUAL ASSEMBLY		MACHINE RUN	
		ORDER NUMBER 944500 1 Kit	ORDER NUMBER 944510 10 Kits	ORDER NUMBER 944525 25 Kits	ORDER NUMBER 944550 50 Kits
Board		1	10	25	50
QFP80	0.8mm	2	20	50	100
PLCC20	1.27mm	2	20	50	100
PLCC28	1.27mm	2	20	50	100
PLCC68	1.27mm	2	20	50	100
SO14	1.27mm	6	60	150	300
SOL20	1.27mm	6	60	150	300
0402 Chips		6	60	150	300
0805 Chips		8	80	200	400
1206 Chips		12	120	300	600
2225 Cap		2	20	50	100
Tantalum 3528	B-Case	2	20	50	100
Tantalum 7343	D-Case	2	20	50	100
SOT23		4	40	100	400
SOT89		4	40	100	200

Lead Free (Pb-Free) Option

Description	Spare Board	1 Kit	10 Kits	25 Kits	50 Kits	100 Kits
Lead Free						
Sn – Tin	944502	944200	944210	944225	944250	944299
Ag – Silver	944506	944600	944610	944625	944650	944699
Cu – OSP	944508	944800	944810	944825	944850	944899
Au – Gold	944509	944900	944910	944925	944950	944999
Standard						
SnPb – HASL	944501	944500	944510	944525	944550	944599

Free Solder Paste Gerber + Parts Placement download www.topline.tv/GerbbersFree.cfm

TopLine®



REWORK 3 PRACTICE KIT

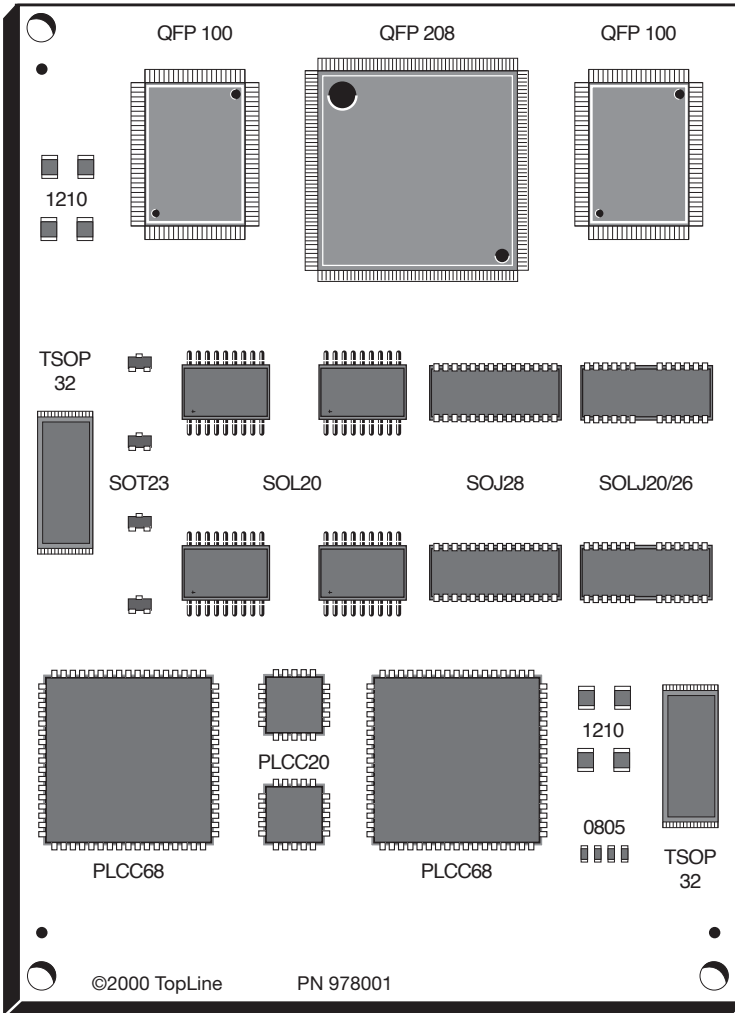

This Rework Practice Kit is available populated and unassembled. Includes fine-pitch components often found in real work situations.

FEATURES

- LPI Soldermask
- FR4 Board .062"
- Single Sided
- Tooling Holes
- Fiducial Marks



Actual Size 4" x 5.5" (100 x 140mm)



REWORK 3 PRACTICE KIT



KIT ORDERING INFORMATION

COMPONENT	PITCH	 MANUAL ASSEMBLY		 MACHINE RUN		
		ORDER NUMBER 978000 1 Kit	ORDER NUMBER 978010 10 Kits	ORDER NUMBER 978025 25 Kits	ORDER NUMBER 978050 50 Kits	ORDER NUMBER 978100 100 Kits
Board		1	10	25	50	100
QFP208	0.5mm	1	10	25	50	100
QFP100	0.65mm	2	20	50	100	200
TSOP32	0.5mm	2	20	50	100	200
PLCC20	50mil	2	20	50	100	200
PLCC68	50mil	2	20	50	100	200
SOL20	50mil	4	40	100	200	400
SOJ28	50mil	2	20	50	100	200
*SOJ20/26	50mil	2	20	50	100	200
SOT23		4	50	100	200	400
0805		4	50	100	200	400
1210		8	100	200	400	800

*SOJ20/26 only in SnPb Kits

Lead Free (Pb-Free) Option

Description	Spare Board	1 Kit	10 Kits	25 Kits	50 Kits	100 Kits
Lead Free						
Sn – Tin	978002	978200	978210	978225	978250	978299
Ag – Silver	978006	978600	978610	978625	978650	978699
Cu – OSP	978008	978800	978810	978825	978850	978899
Au – Gold	978009	978900	978910	978925	978950	978999
Standard						
SnPb – HASL	978001	978000	978010	978025	978050	978100

Free Solder Paste Gerber + Parts Placement download www.topline.tv/GerbersFree.cfm

TopLine[®]

SMT INTRODUCTORY KIT SURFACE MOUNT TECHNOLOGY



SMD Introductory Kit

PN 925001

© 1998 TopLine

Fax 1-714-891-0321

Ph 1-714-898-3830

PLCC 68

QFP100 .65mm

SOJ24

A Tantalum

C Tantalum

Pot.

SOL 20

PLCC 20

B Tantalum

D Tantalum

SOM 16

MINI

MELF

MELF

SO 14

TRANSISTORS

SOT 23

SOT 89

SOT 143

SOT 223

D PAK

FLAT CHIPS

0805

1206

1210

1812

2225

The SMD Introductory Kit includes a wide range of popular easy-to-handle components.

FEATURES

- LPI Solder Mask
- FR4 Board .062"
- Double Sided
- Tooling Holes .125"
- Fiducial Marks



Actual Size: 4" x 5.5" (100mm x 140mm)

Rev B

TopLine® SMT INTRODUCTORY KIT SURFACE MOUNT TECHNOLOGY



KIT ORDERING INFORMATION

COMPONENT	PITCH	 MANUAL ASSEMBLY		 MACHINE RUN		
		ORDER NUMBER	ORDER NUMBER	ORDER NUMBER	ORDER NUMBER	ORDER NUMBER
		925000 1 Kit	925010 10 Kits	925025 25 Kits	925050 50 Kits	925100 100 Kits
Board		1	10	25	50	100
QFP100	0.65mm	1	10	25	50	100
SO14	50mils	1	10	25	50	100
SOM16	50mils	1	10	25	50	100
SOL20	50mils	1	10	25	50	100
PLCC20	50mils	1	10	25	50	100
PLCC68	50mils	1	10	25	50	100
SOT23		3	30	75	250	300
SOT89		2	20	50	100	200
SOT143		1	10	25	50	100
SOT223		1	10	25	50	100
DKPAK		1	10	25	50	100
Tantalum-A		1	10	25	50	100
Tantalum-B		1	10	25	50	100
Tantalum-C		1	10	25	50	100
Tantalum-D		1	10	25	50	100
MELF		2	20	50	100	200
mini-MELF		6	60	300	300	600
Potentiometer		1	10	25	50	100
0805 Chip		10	100	250	500	1000
1206 Chip		10	100	250	500	1000
1210 Chip		10	100	250	500	1000
1812 Chip		2	20	50	100	200
2225 Chip		1	10	25	50	100

Lead Free (Pb-Free) Option

Description	Spare Board	1 Kit	10 Kits	25 Kits	50 Kits	100 Kits
Lead Free						
Sn - Tin	925002	925200	925210	925225	925250	925299
Ag - Silver	925006	925600	925610	925625	925650	925699
Cu - OSP	925008	925800	925810	925825	925850	925899
Au - Gold	925009	925900	925910	925925	925950	925999
Standard						
SnPb - HASL	925001	925000	925010	925025	925050	925100

Free Solder Paste Gerber + Parts Placement download www.topline.tv/GerbbersFree.cfm

TopLine[®]



PRACTICAL MIXED TECHNOLOGY KIT



A low-cost, mixed technology kit for rework and solder practice. Includes simple-to-handle components. Excellent for beginners. Can also be used for medium speed assembly.

P/N 926001

© 1997 TopLine

Fax 1-714-891-0321

Ph 1-714-898-3830

Practical Kit

SOM16

PLCC20

QFP44 .8mm

QFP100 .65mm

QFP64 1.0mm

PLCC20

DIP

SOT23

PLCC68

1206 (3216)

0805 (2012)

PLCC44

PLCC44

PLCC68

- FEATURES**
- LPI Solder Mask
 - FR4 Board .062"
 - Double Sided
 - Tooling Holes .125"
 - Fiducial Marks
 - Plated Throughholes



Actual Size: 4" x 5.5" (100 x 140mm)



PRACTICAL MIXED TECHNOLOGY KIT



KIT ORDERING INFORMATION

COMPONENT	PITCH	 MANUAL ASSEMBLY		 MACHINE RUN		
		ORDER NUMBER 926000 1 KIT	ORDER NUMBER 926010 10 KITS	ORDER NUMBER 926025 25 KITS	ORDER NUMBER 926050 50 KITS	ORDER NUMBER 926100 100 KITS
Board		1	10	25	50	100
QFP100	0.65mm	1	10	25	50	100
QFP44	0.80mm	1	10	25	50	100
QFP64	1.00mm	1	10	25	50	100
PLCC20	50mils	2	25	50	100	200
PLCC44	50mils	2	25	50	100	200
PLCC68	50mils	2	25	50	100	200
SOM16	50mils	2	25	50	100	200
DIP14~18	100mils	1	10	25	50	100
SOT23		10	50	500	500	500
0805 Chip		10	100	500	500	1000
1206 Chip		10	100	250	500	1000

Lead Free (Pb-Free) Option

Description	Spare Board	1 Kit	10 Kits	25 Kits	50 Kits	100 Kits
Lead Free						
Sn - Tin	926002	926200	926210	926225	926250	926299
Ag - Silver	926006	926600	926610	926625	926650	926699
Cu - OSP	926008	926800	926810	926825	926850	926899
Au - Gold	926009	926900	926910	926925	926950	926999
Standard						
SnPb - HASL	926001	926000	926010	926025	926050	925100

Free Solder Paste Gerber + Parts Placement download www.topline.tv/GerbbersFree.cfm



Experiment with mixed technology. Combines easy-to-handle SMD components plus plenty of through-hole components on 100mil grid.

PN 969601

© 1998 TopLine

Fax 1-714-891-0321

Ph 1-714-898-3830

TopLine Mixed Technology Kit

PLCC 68

QFP100 .65mm

SOL 20

A Tantalum

C Tantalum

Pot.

SOM 16

B Tantalum

D Tantalum

MELF

SO 14

PLCC 20

MINI MELF

SOT 23

SOT 89

SOT 143

SOT 223

D PAK

0805 (2012)

1206 (3216)

1210 (3225)

1812 (4532)

2225 (5664)

Plated Through holes

Actual Size: 4" x 5.5" (100 x 140mm)

FEATURES

- LPI Solder Mask
- FR4 Board .062"
- Double Sided
- Tooling Holes .125"
- Fiducial Marks
- Plated Throughholes



KIT ORDERING INFORMATION

		MANUAL ASSEMBLY		MACHINE RUN		
		ORDER NUMBER 969600 1 Kit	ORDER NUMBER 969610 10 Kits	ORDER NUMBER 969625 25 Kits	ORDER NUMBER 969650 50 Kits	ORDER NUMBER 969699 100 Kits
COMPONENT	PITCH					
Board		1	10	25	50	100
QFP100	0.65mm	1	10	25	50	100
SO14	50mils	1	10	25	50	100
SOM16	50mils	1	10	25	50	100
SOL20	50mils	1	10	25	50	100
PLCC20	50mils	1	10	25	50	100
PLCC68	50mils	1	10	25	50	100
DIP14~20	100mils	4	40	100	200	400
SOT23 & SOT89		3	30	75	150	300
SOT143		1	10	25	50	100
SOT223		1	10	25	50	100
DPAK		1	10	25	50	100
Tantalum-A		1	10	25	50	100
Tantalum-B		1	10	25	50	100
Tantalum-C		1	10	25	50	100
Tantalum-D		1	10	25	50	100
MELF		2	20	50	100	200
mini-MELF		6	60	150	300	600
Potentiometer		1	10	25	50	100
0805 Chip		10	100	250	500	1000
1206 Chip		10	100	250	500	1000
1210 Chip		10	100	250	500	1000
1812 Chip		2	20	100	100	200
2225 Chip		1	10	25	50	100

Lead Free (Pb-Free) Option

Description	Spare Board	1 Kit	10 Kits	25 Kits	50 Kits	100 Kits
Lead Free						
Sn - Tin	969602	969200	969210	969225	969250	969299
Ag - Silver	969606	969700	969710	969725	969750	969799
Cu - OSP	969608	969800	969810	969825	969850	969899
Au - Gold	969609	969900	969910	969925	969950	969999
Standard						
SnPb - HASL	969601	969600	969610	969625	969650	969699

Free Solder Paste Gerber + Parts Placement download www.topline.tv/GerbbersFree.cfm

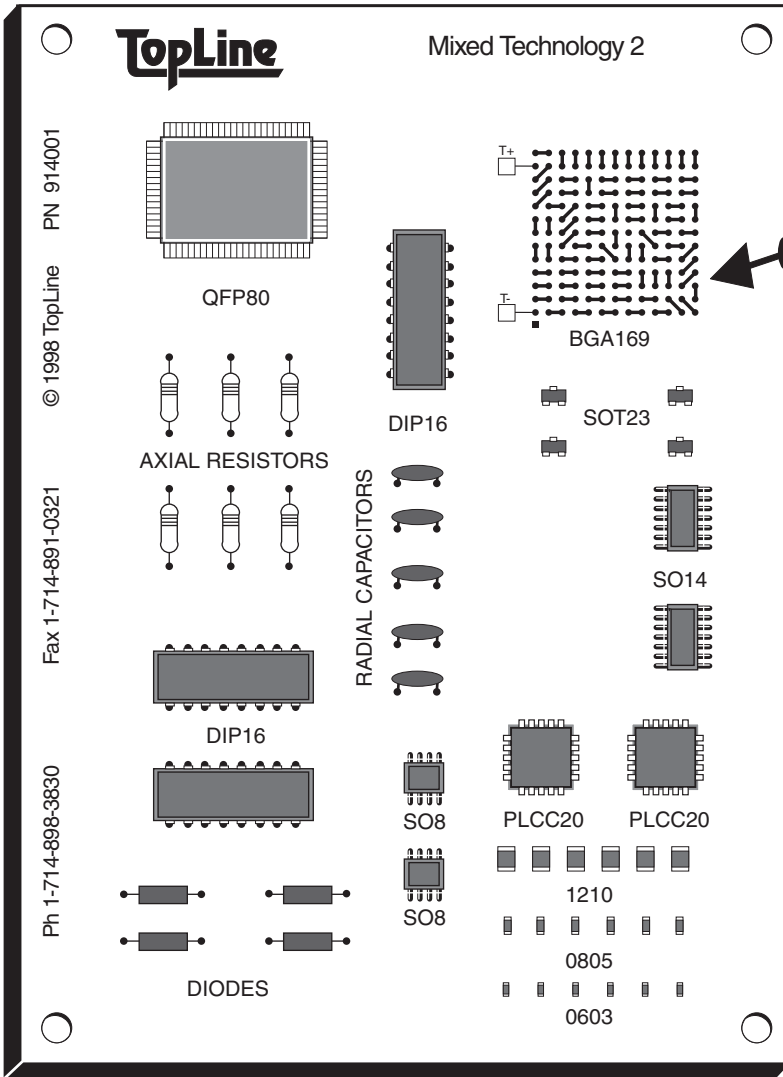

The mixed technology 2 kit provides plenty of plated throughholes as well as BGA and an easy-to-solder QFP.

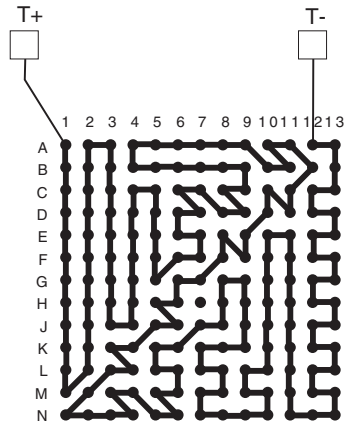

BGA169
AFTER MOUNTING

FEATURES

- LPI Solder Mask
- FR4 Board .062" (standard)
- Single Sided
- Tooling Holes .125"
- Fiducial Marks
- Plated Throughholes



Actual Size: 4" x 5.5" (100 x 140mm)



MIXED TECHNOLOGY 2 KIT



KIT ORDERING INFORMATION

COMPONENT	PITCH	 MANUAL ASSEMBLY		 MACHINE RUN		
		ORDER NUMBER	ORDER NUMBER	ORDER NUMBER	ORDER NUMBER	ORDER NUMBER
		914000 1 KIT	914010 10 KITS	914025 25 KITS	914050 50 KITS	914100 100 KITS
Board		1	10	25	50	100
QFP80	0.8mm	1	10	25	50	100
BGA169	1.5mm	1	10	25	50	100
SO8	1.27mm	2	25	50	100	200
SO14	1.27mm	2	25	50	100	200
PLCC20	50mil	2	25	50	100	200
SOT23		4	40	100	200	400
1210 Chip		6	60	150	300	600
0805 Chip		10	100	250	500	1000
0603 Chip		10	100	250	500	1000
THROUGH HOLE COMPONENTS						
DIP16	100mil	3	30	75	150	300
1/4W Resistor	.50"	6	60	150	300	600
DO35 Diodes	.50"	4	40	200	200	400
Ceramic Cap	.20"	5	50	250	250	500

Lead Free (Pb-Free) Option

Description	Spare Board	1 Kit	10 Kits	25 Kits	50 Kits	100 Kits
Lead Free						
Sn - Tin	914002	914200	914210	914225	914250	914299
Ag - Silver	914006	914600	914610	914625	914650	914699
Cu - OSP	914008	914800	914810	914825	914850	914899
Au - Gold	914009	914900	914910	914925	914950	914999
Standard						
SnPb - HASL	914001	914000	914010	914025	914050	914100

Free Solder Paste Gerber + Parts Placement download www.topline.tv/GerbersFree.cfm



CHIP SHOOTER KIT

0201 AND 0402 CHIPS

REV B WITH DAISY CHAIN



Top Side of Board

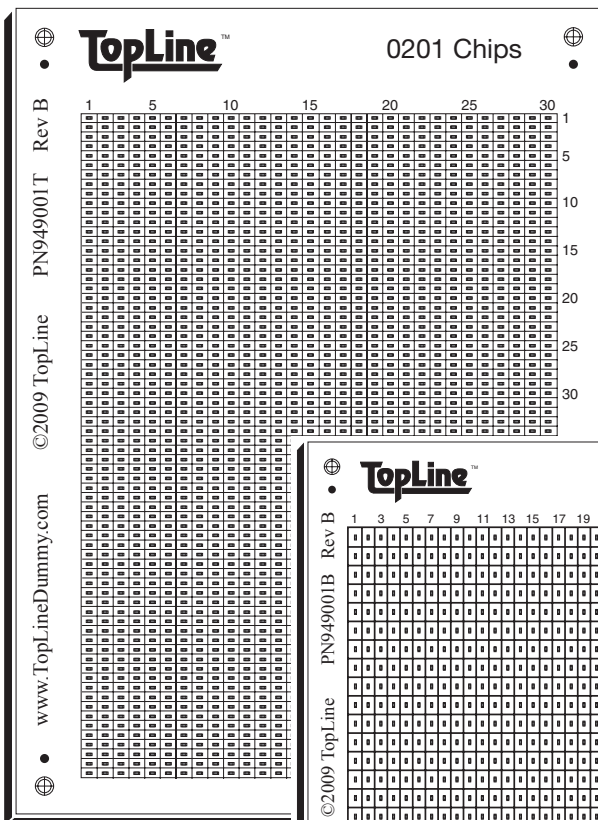

Put your machine to the test with TopLine's new 0201/0402 kits. Double sided board has 2000 pads for ultra-miniature 0201 chips on the front side and 1000 pads for 0402 chips on the back side. Components are supplied on 2mm pitch tape. Kit can be used for placement, soldering or epoxy dispenser testing. Rev B has test points for continuity testing.

Bottom Side of Board

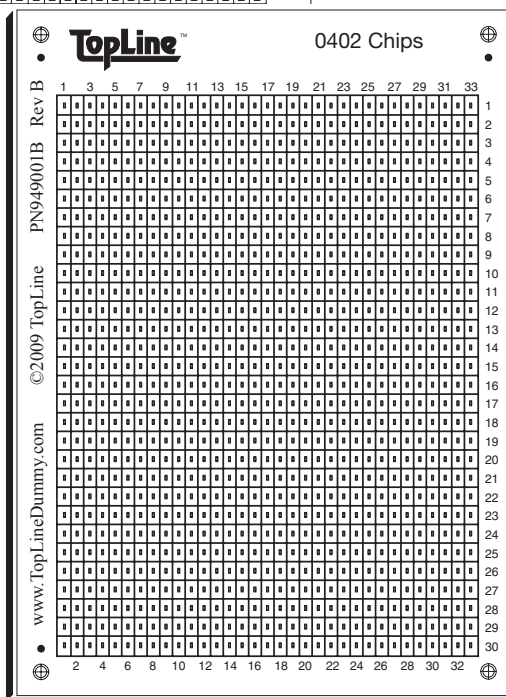

Pad Dimensions (mm)
Rev-B

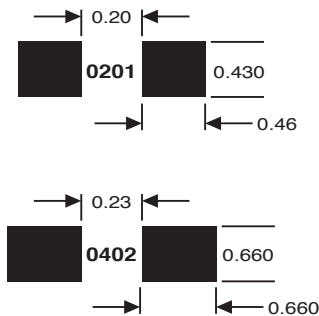

FEATURES

- LPI Solder Mask
- FR4 Board .062" thick
- Double Sided
- Tooling Holes .125"
- Fiducial Marks

Actual Size: 4" x 5.5" (100 x 140mm)

TopLine®



CHIP SHOOTER KIT 0201 AND 0402 CHIPS ZERO OHM DAISY CHAIN



KIT ORDERING INFORMATION

COMPONENT	TAPE PITCH	MACHINE RUN				
		ORDER NUMBER 949000 1 KIT	ORDER NUMBER 949010 10 KITS	ORDER NUMBER 949025 25 KITS	ORDER NUMBER 949050 50 KITS	ORDER NUMBER 949100 100 KITS
Board	-	1	10	25	50	100
0201 Chip	2mm	2000	15,000	45,000	100,000	200,000
0402 Chip	2mm	1000	10,000	25,000	50,000	100,000

Lead Free (Pb-Free) Option

Description	Spare Board	1 Kit	10 Kits	25 Kits	50 Kits	100 Kits
Lead Free						
Sn – Tin	949002	949200	949210	949225	949250	949299
Ag – Silver	949006	949600	949610	949625	949650	949699
Cu – OSP	949008	949800	949810	949825	949850	949899
Au – Gold	949009	949900	949910	949925	949950	949999
Standard						
SnPb – HASL	949001	949000	949010	949025	949050	949100

Free Solder Paste Gerber + Parts Placement download www.topline.tv/GerbbersFree.cfm

TopLine[®]

CHIP SHOOTER KIT 0402 AND 0603 CHIPS ZERO OHM DAISY CHAIN

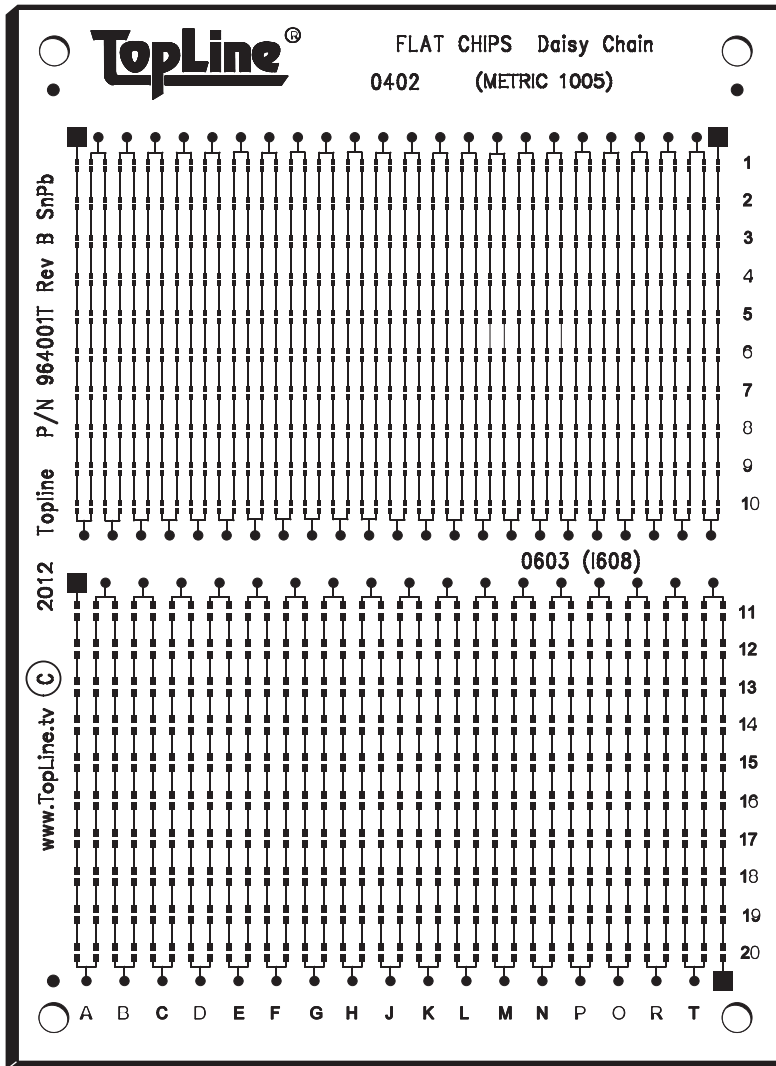

TopLine has thousands of zer-ohm 0402 and 0603 resistors for your machine to place. 0402 chips are supplied on tape with 2mm pitch and the 0603 chips with 4mm pitch tape. Double sided board has 460 pads for 0402 chip and 350 pads for 0603 chip per side. 1600 pads total! This kit can be used for placement, soldering or epoxy dispenser testing.

Pad Dimensions (mm)
Rev-A

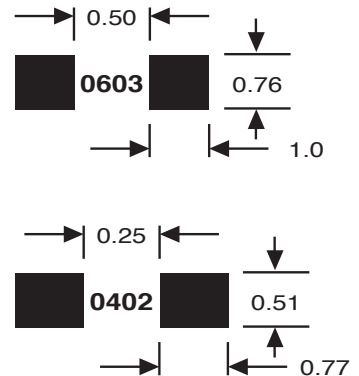

FEATURES

- LPI Solder MaskFR4 Board .062"
- Double Sided
- Tooling Holes .125"
- Fiducial Marks

Actual Size: 4" x 5.5" (100 x 140mm)



CHIP SHOOTER KIT 0402 AND 0603 CHIPS ZERO OHM DAISY CHAIN



KIT ORDERING INFORMATION

COMPONENT	 MACHINE RUN				
	ORDER NUMBER 964000 1 KIT	ORDER NUMBER 964010 10 KITS	ORDER NUMBER 964025 25 KITS	ORDER NUMBER 984050 50 KITS	ORDER NUMBER 964100 100 KITS
DAISY CHAIN KIT					
Board	1	10	25	50	100
0402 Chip Resistor	1000	10,000	20,000	40,000	80,000
0603 Chip Resistor	1000	10,000	15,000	30,000	60,000

Lead Free (Pb-Free) Option

Description	Spare Board	1 Kit	10 Kits	25 Kits	50 Kits	100 Kits
Lead Free						
Sn – Tin	964002	964200	964210	964225	964250	964299
Ag – Silver	964006	964600	964610	964625	964650	964699
Cu – OSP	964008	964800	964810	964825	964850	964899
Au – Gold	964009	964900	964910	964925	964950	964999
Standard						
SnPb – HASL	964001	964000	964010	964025	964050	964100

Free Solder Paste Gerber + Parts Placement download www.topline.tv/GerbbersFree.cfm

Note: 984001 is now 964002

TopLine®



CHIP SHOOTER KIT 0805 AND 1206 CHIPS

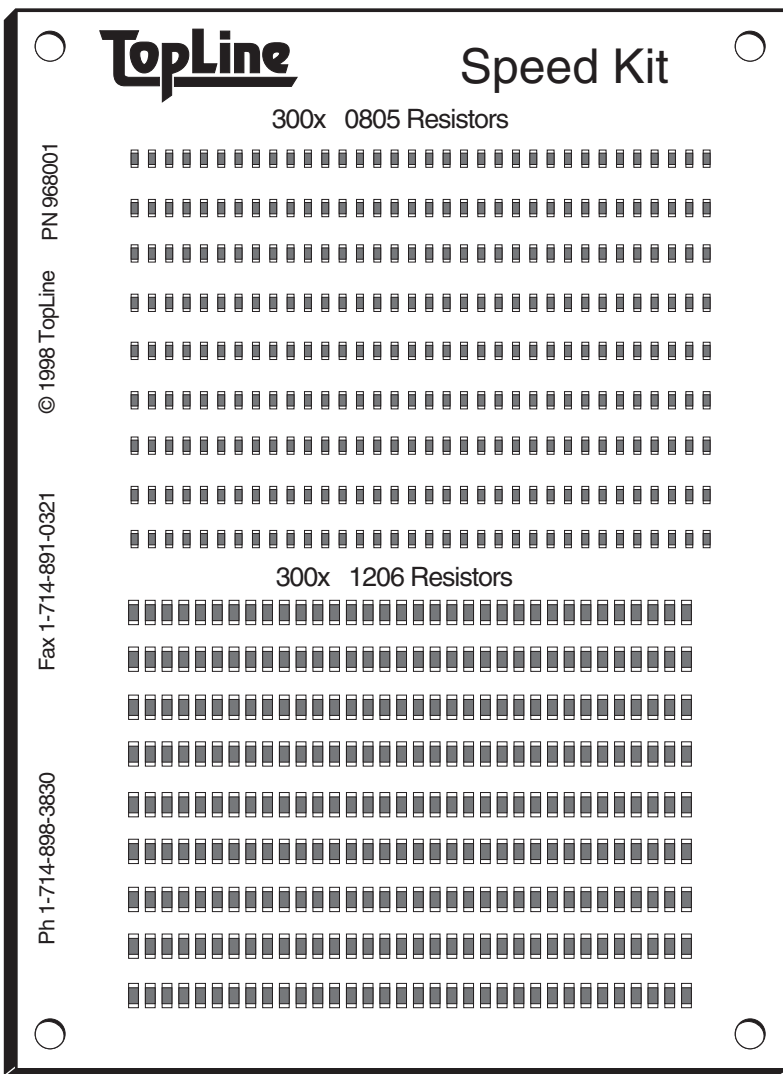

Put your machine to the test . This Kit is a low cost way for you to measure the component per hour (CPH) rating of pick & place machines. Use to benchmark and compare the performance of different machines.

Each side has land patterns for 300 each 0805 and 1206. Total of 1200 pads on the board.

This kit can be used for placement, soldering or epoxy dispenser testing.

Pad Dimensions (mm)
Rev-A

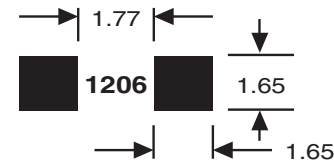
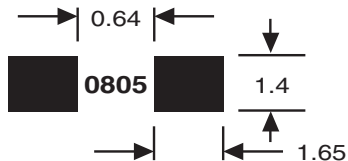

FEATURES

- LPI Solder Mask
- FR4 Board .062"
- Double Sided
- Tooling Holes .125"
- Fiducial Marks

Actual Size: 4" x 5.5" (100 x 140mm)



CHIP SHOOTER KIT 0805 AND 1206 CHIPS



KIT ORDERING INFORMATION



MACHINE RUN

COMPONENT	ORDER NUMBER	ORDER NUMBER	ORDER NUMBER	ORDER NUMBER	ORDER NUMBER
	968000 1 KIT	968010 10 KIT	968025 25 KITS	968050 50 KITS	968100 100 KITS
KIT					
Board	1	10	25	50	100
0805 Chip Resistor	300	3,000	7,500	15,000	30,000
1206 Chip Resistor	300	3,000	7,500	15,000	30,000

Lead Free (Pb-Free) Option

Description	Spare Board	1 Kit	10 Kits	25 Kits	50 Kits	100 Kits
Lead Free						
Sn – Tin	968002	968200	968210	968225	968250	968299
Ag – Silver	968006	968600	968610	968625	968650	968699
Cu – OSP	968008	968800	968810	968825	968850	968899
Au – Gold	968009	968900	968910	968925	968950	968999
Standard						
SnPb – HASL	968001	968000	968010	968025	968050	968100

Free Solder Paste Gerber + Parts Placement download www.topline.tv/GerbersFree.cfm

Note: 983001 is now 968002

TopLine[®]

ADVANCED SMD KIT FOR THE EXPERT



TopLine

Advanced Kit

PN 930001

© 1998 TopLine

Fax 1-714-891-0321

Ph 1-714-898-3830

QFP 256 .4mm

TSOP32
.5mm

QFP 120 .8mm

LQFP100 .5mm

QFP100 .65mm

QFP 208 .5mm

LQFP144 .5mm

QFP 160 .65mm

QFP64 1.0mm

BQFP100 25Mil

Put your machine through its paces with the Advanced SMD Kit. Includes a wide selection of fine-pitch parts from 0.4mm pitch. All components are packaged on tape and reel for machine run. Also available single packed for manual assembly.

FEATURES

- LPI Solder Mask
- FR4 Board .062"
- Double Sided
- Tooling Holes .125"
- Fiducial Marks



Actual Size: 4" x 5.5 (100 x 140mm)



ADVANCED SMD KIT FOR THE EXPERT



KIT ORDERING INFORMATION

COMPONENT	PITCH	 MANUAL ASSEMBLY		 MACHINE RUN		
		ORDER NUMBER 931000 1 KIT	ORDER NUMBER 931010 10 KITS	ORDER NUMBER 931024 24 KITS	ORDER NUMBER 931048 48 KITS	ORDER NUMBER 931096 96 KITS
Board		1	10	24	48	96
QFP256	0.4mm	1	10	24	48	96
QFP208	0.5mm	1	10	24	48	96
LQFP144	0.5mm	1	10	24	48	96
LQFP100	0.5mm	1	10	24	48	96
TSOP32	0.5mm	1	10	24	48	96
QFP100	0.65mm	1	10	24	48	96
*BQFP100	25.0mil	1	10	24	48	96
QFP160	0.65mm	1	10	24	48	96
*QFP120	0.8mm	1	10	24	48	96
QFP64	1.0mm	1	10	24	48	96

*BQFP100 and QFP120 only in SnPb Kit

Lead Free (Pb-Free) Option

Description	Spare Board	1 Kit	10 Kits	24 Kits	48 Kits	96 Kits
Lead Free						
Sn – Tin	930002	931200	931210	931224	931248	931296
Ag – Silver	930006	931600	931610	931624	931648	931696
Cu – OSP	930008	931800	931810	931824	931848	931896
Au – Gold	930009	931900	931910	931924	931948	931996
Standard						
SnPb – HASL	930001	931000	931010	931024	931048	931100

Free Solder Paste Gerber + Parts Placement download www.topline.tv/GerbbersFree.cfm

TopLine[®]



28MM QFP ASSORTMENT KIT 0.4MM TO 0.8MM PITCH



TopLine 28mm QFP Assortment

PN 962001
© 1997 TopLine
Fax 1-714-891-0321
Ph 1-714-898-3830

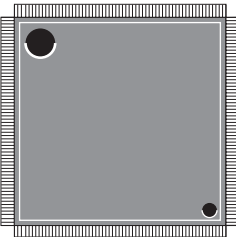

QFP 256 .4mm

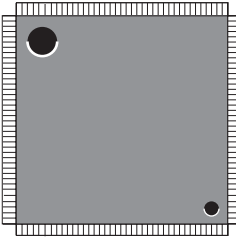

QFP 160 .65mm

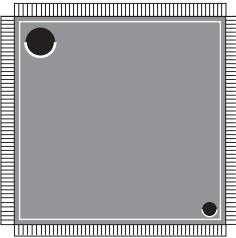

QFP 208 .5mm

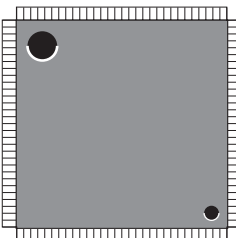

QFP 120 .8mm

Try them all. We give you four different lead pitches: 0.4mm, 0.5mm, 0.65mm and 0.8mm. Experience the differences in levels as you progress to 0.4mm pitch.

FEATURES

- LPI Solder Mask
- FR4 Board .062"
- Double Sided
- Tooling Holes .125"
- Fiducial Marks



Actual Size: 4" x 5.5" (100 x 140mm)



28MM QFP ASSORTMENT KIT 0.4MM TO 0.8MM PITCH



KIT ORDERING INFORMATION

COMPONENT	PITCH	 MANUAL ASSEMBLY		 MACHINE RUN		
		ORDER NUMBER 962000 1 KIT	ORDER NUMBER 962012 12 KITS	ORDER NUMBER 962024 24 KITS	ORDER NUMBER 962048 48 KITS	ORDER NUMBER 962096 96 KITS
Board		1	12	24	48	96
QFP256	0.4mm	1	12	24	48	96
QFP208	0.5mm	1	12	24	48	96
QFP160	0.65mm	1	12	24	48	96
*QFP120	0.80mm	1	12	24	48	96

*QFP120 only in SnPb Kit

Lead Free (Pb-Free) Option

Description	Spare Board	1 Kit	12 Kits	24 Kits	48 Kits	96 Kits
Lead Free						
Sn – Tin	962002	962200	962212	962224	962248	962296
Ag – Silver	962007	962600	962612	962624	962648	962696
Cu – OSP	962008	962800	962812	962824	962848	962896
Au – Gold	962009	962900	962912	962924	962948	962996
Standard						
SnPb – HASL	962001	962000	962012	962024	962048	962096

Free Solder Paste Gerber + Parts Placement download www.topline.tv/GerbbersFree.cfm

TopLine[®]



QFP256 KIT 0.4MM PITCH



TopLine 4X QFP256
P= .4mm /15.7Mil

PN962501
© 1998 TopLine
Fax 1-714-891-0321
Ph 1-714-898-3830

QFP 256 QFP 256
QFP 256 QFP 256

The diagram shows a rectangular board with four circular fiducial marks at the corners. In the center, there are four square QFP 256 packages arranged in a 2x2 grid. Each package is a square with a dense array of pins on all four sides. The board is labeled with the TopLine logo and product information at the top, and contact information on the left side.

Be on the cutting edge with 0.4mm (15.7Mil) pitch. It's guaranteed to push vision and soldering equipment to its limits.

FEATURES

- LPI Solder Mask
- FR4 Board .062"
- Double Sided
- Tooling Holes .125"
- Fiducial Marks

Actual Size: 4" x 5.5" (100 x 140mm)

TopLine®





QFP256 KIT

0.4MM PITCH



KIT ORDERING INFORMATION

COMPONENT	PITCH	 MANUAL ASSEMBLY	 MACHINE RUN			
		ORDER NUMBER 962500 1 KIT	ORDER NUMBER 962512 12 KITS	ORDER NUMBER 962524 24 KITS	ORDER NUMBER 962548 48 KITS	ORDER NUMBER 962596 96 KITS
Board QFP256	0.4mm	1 4	12 48	24 96	48 192	96 384

Lead Free (Pb-Free) Option

Description	Spare Board	1 Kit	12 Kits	24 Kits	48 Kits	96 Kits
Lead Free						
Sn – Tin	962502	962520	962521	962522	962525	962529
Ag – Silver	962507	962560	962561	962562	962565	962569
Cu – OSP	962508	962580	962581	962582	962585	962589
Au – Gold	962509	962590	962591	962592	962595	962599
Standard						
SnPb – HASL	962501	962500	962512	962524	962548	962596

Free Solder Paste Gerber + Parts Placement download www.topline.tv/GerbbersFree.cfm

TopLine[®]



QFP208 KIT

0.5MM PITCH



TopLine 4X QFP208
P= .5mm /19.7Mil

PN 962101
© 1998 TopLine
Fax 1-714-891-0321
Ph 1-714-898-3830

QFP 208 QFP 208

QFP 208 QFP 208

The image shows a rectangular board with four square QFP 208 components arranged in a 2x2 grid. Each component has a central square area and a perimeter of fine lines representing leads. The board has four circular fiducial marks at the corners. Text on the board includes the TopLine logo, part number, copyright, phone/fax numbers, and component labels.

Practice assembling 0.5mm (19.7Mil) pitch. The QFP208 is a very popular package. Components are provided on tape and reel.

FEATURES

- LPI Solder Mask
- FR4 Board .062"
- Double Sided
- Tooling Holes .125"
- Fiducial Marks

Actual Size: 4" x 5.5" (100 x 140mm)





QFP208 KIT

0.5MM PITCH



KIT ORDERING INFORMATION

COMPONENT	PITCH	 MANUAL ASSEMBLY	 MACHINE RUN			
		ORDER NUMBER 962100 1 KIT	ORDER NUMBER 962112 12 KITS	ORDER NUMBER 962124 24 KITS	ORDER NUMBER 962148 48 KITS	ORDER NUMBER 962196 96 KITS
Board QFP208	0.5mm	1 4	12 48	24 96	48 192	96 384

Lead Free (Pb-Free) Option

Description	Spare Board	1 Kit	12 Kits	24 Kits	48 Kits	96 Kits
Lead Free						
Sn – Tin	962102	962120	962121	962122	962125	962129
Ag – Silver	962107	962160	962161	962162	962165	962169
Cu – OSP	962108	962180	962181	962182	962185	962189
Au – Gold	962109	962190	962191	962192	962195	962199
Standard						
SnPb – HASL	962101	962100	962112	962124	962148	962196

Free Solder Paste Gerber + Parts Placement download www.topline.tv/GerbbersFree.cfm

TopLine®

ROTATIONAL PLACEMENT KIT

TESTS ACCURACY TO $\pm 0.5^\circ$

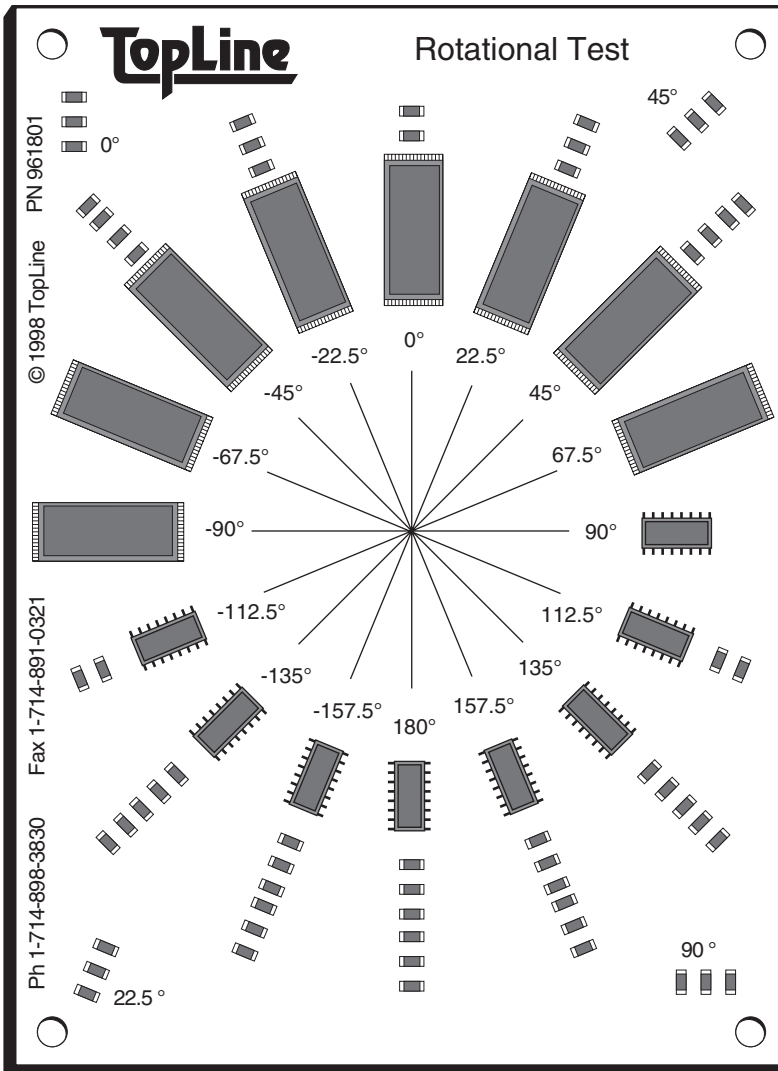

Be on target! Some problems do not become evident until you start rotating components. TopLine's Rotational Placement Kit is designed to test the rotational accuracy on your system to $\pm 0.5^\circ$.

FEATURES

- LPI Solder Mask
- FR4 Board .062"
- Double Sided
- Tooling Holes .125"
- Fiducial Marks

Actual Size: 4" x 5.5" (100 x 140mm)





ROTATIONAL PLACEMENT KIT

TESTS ACCURACY TO $\pm 0.5^\circ$



KIT ORDERING INFORMATION

COMPONENT	PITCH	 MANUAL ASSEMBLY	 MACHINE RUN		
		ORDER NUMBER 961800 1 KIT	ORDER NUMBER 961806 6 KITS	ORDER NUMBER 961812 12 KITS	ORDER NUMBER 961825 25 KITS
Board		1	6	12	25
TSOP32	0.5mm	8	50	100	200
SO16	1.27mm	8	50	100	200
1206 Chips		60	300	750	1500

Lead Free (Pb-Free) Option

Description	Spare Board	1 Kit	12 Kits	25 Kits	50 Kits
Lead Free					
Sn – Tin	961802	-	961821	961822	961824
Ag – Silver	961807	-	961861	961862	961864
Cu – OSP	961808	-	961881	961882	961884
Au – Gold	961809	-	961891	961892	961894
Standard					
SnPb – HASL	961801	961800	961812	961825	961850

Free Solder Paste Gerber + Parts Placement download www.topline.tv/GerbersFree.cfm

QFN DAISY CHAIN KIT

3 ~ 12MM

PITCH 0.4 ~ 0.65MM

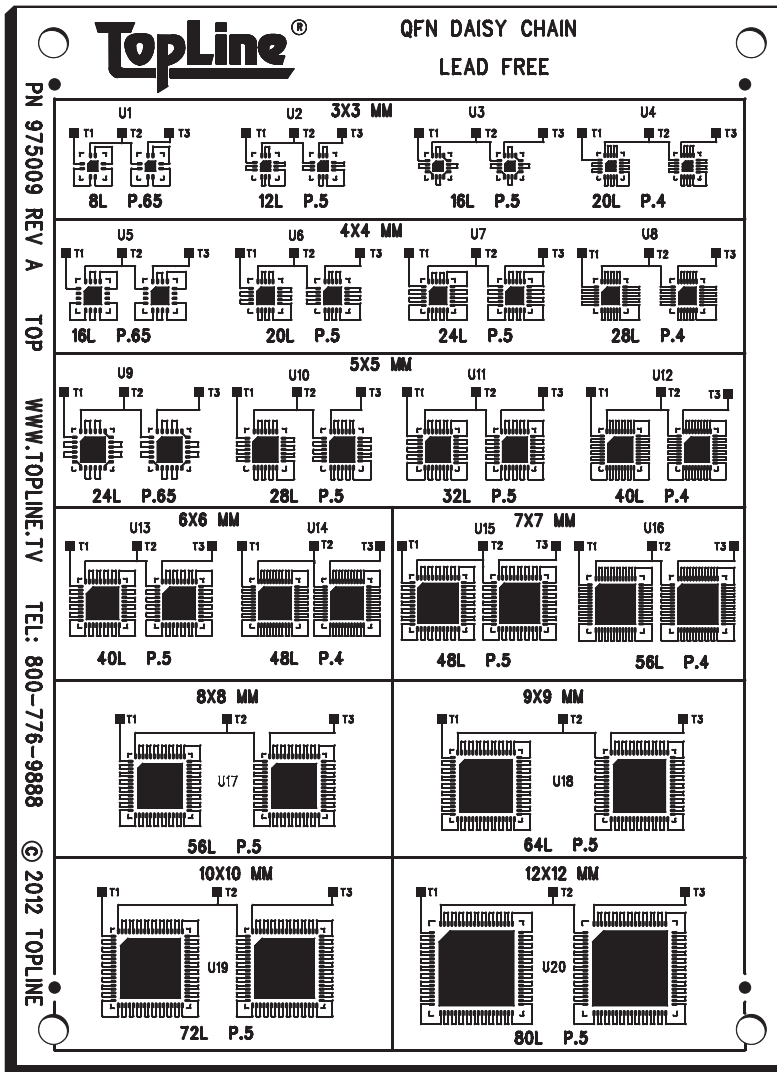

This kit provides a wide variety of daisy chain bottom terminal QFN components 8 ~ 80pins for solder practice and continuity testing. Pitch 0.4mm to 0.65mm provides advanced and easy to handle combinations. Component size 3mm to 12mm covers the full range of package sizes. Large ground pads present a challenge for correct solder paste deposition and reflow. Test terminals T1-T2-T3 provide easy method to verify zero ohm continuity testing after assembly and reflow.

FEATURES

- LPI Solder Mask
- FR4 Board .062"
- Double Sided
- Tooling Holes .125"
- Fiducial Marks

Actual Size: 4" x 5.5" (100 x 140mm)





QFN DAISY CHAIN KIT

3 ~ 12MM

PITCH 0.4 ~ 0.65MM



KIT ORDERING INFORMATION

COMPONENT	PITCH	 MANUAL ASSEMBLY	 MACHINE RUN		
		NUMBER 975200 1 KIT	ORDER NUMBER 975205 5 KITS	ORDER NUMBER 975210 10 KITS	ORDER NUMBER 975225 25 KITS
Board		1	5	10	25
QFN 16L 3x3mm	0.5mm	2	10	20	50
QFN 16L 4x4mm	0.65mm	2	10	20	50
QFN 20L 4x4mm	0.5mm	2	10	20	50
QFN 24L 4x4mm	0.5mm	2	10	20	50
QFN 24L 5x5mm	0.65mm	2	10	20	50
QFN 28L 5x5mm	0.5mm	2	10	20	50
QFN 32L 5x5mm	0.5mm	2	10	20	50
QFN 40L 6x6mm	0.5mm	2	10	20	50
QFN 48L 7x7mm	0.5mm	2	10	20	50
QFN 56L 8x8mm	0.5mm	2	10	20	50
QFN 64L 9x9mm	0.5mm	2	10	20	50
QFN 72L 10x10mm	0.5mm	2	10	20	50
QFN 80L 12x12mm	0.5mm	2	10	20	50

* Note: All QFN are Lead-Free (Pb-Free)

Lead Free (Pb-Free) Option

Description	Spare Board	1 Kit	5 Kits	10 Kits	25 Kits
Lead Free					
Sn – Tin	975002	975200	975205	975210	975225
Ag – Silver	975006	-	-	-	975625
Cu – OSP	975008	-	-	-	975825
Au – Gold	975009	975900	975905	975910	975925
Standard					
SnPb – HASL	975001	975000	975005	975010	975025

Free Solder Paste Gerber + Parts Placement download www.topline.tv/GerbersFree.cfm

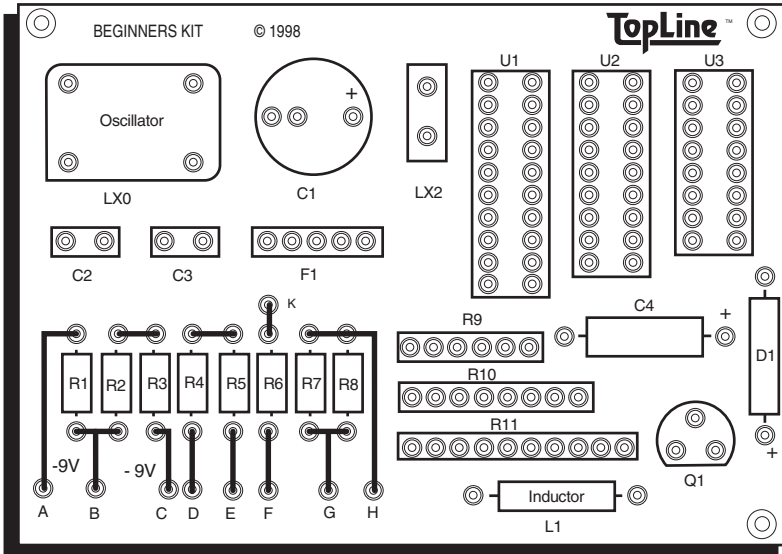

Actual Size: 2.75" x 4.0" (70 x 100mm)

The beginners Through-hole Kit is a low-cost, entry level kit for practicing with a wide range of components. Total of 24 easy-to-identify components are provided in kit.

FEATURES

- FR4 Board .062"
- Single Sided
- Tooling Holes .125"
- Plated Throughholes



KIT ORDERING INFORMATION

		 MANUAL ASSEMBLY				
COMPONENT	BOARD LOCATION	ORDER NUMBER	ORDER NUMBER	ORDER NUMBER	ORDER NUMBER	ORDER NUMBER
		910000 1 KIT	910010 10 KITS	910025 25 KITS	910050 50 KITS	910100 100 KITS
Board		1	10	25	50	100
Oscillator	LX0	1	10	25	50	100
Crystal	LX2	1	10	25	50	100
Radial Aluminum Cap	C1	1	10	25	50	100
Ceramic Capacitor	C2	1	10	25	50	100
Film Capacitor	C3	1	10	25	50	100
Axial Aluminum Cap	C4	1	10	25	50	100
Axial Inductor	L1	1	10	25	50	100
Resistor Network SIP6	R9	1	10	25	50	100
Resistor Network SIP8	R10	1	10	25	50	100
Resistor Network SIP10	R11	1	10	25	50	100
SAW Filter SIP5	F1	1	10	25	50	100
Transistor TO92	Q1	1	10	25	50	100
Rectifier DO35/DO41	D1	1	10	25	50	100
Integrated Circuit DIP16	U1	1	10	25	50	100
Integrated Circuit DIP18	U2	1	10	25	50	100
Integrated Circuit DIP20	U3	1	10	25	50	100
Resistor 1/8 W	R1-4	4	40	100	200	400
Resistor 1/4 W	R5-8	4	40	100	200	400

Lead Free (Pb-Free) Option

Description	Spare Board	1 Kit	10 Kits	25 Kits	50 Kits	100 Kits
Lead Free						
Sn – Tin	910003	910200	910210	910225	910250	910299
Ag – Silver	910006	910600	910610	910625	910650	910699
Cu – OSP	910008	910800	910810	910825	910850	910899
Au – Gold	910009	910900	910910	910925	910950	910999
Standard						
SnPb – HASL	910002	910000	910010	910025	910050	910100

Free Solder Paste Gerber + Parts Placement download www.topline.tv/GerbbersFree.cfm

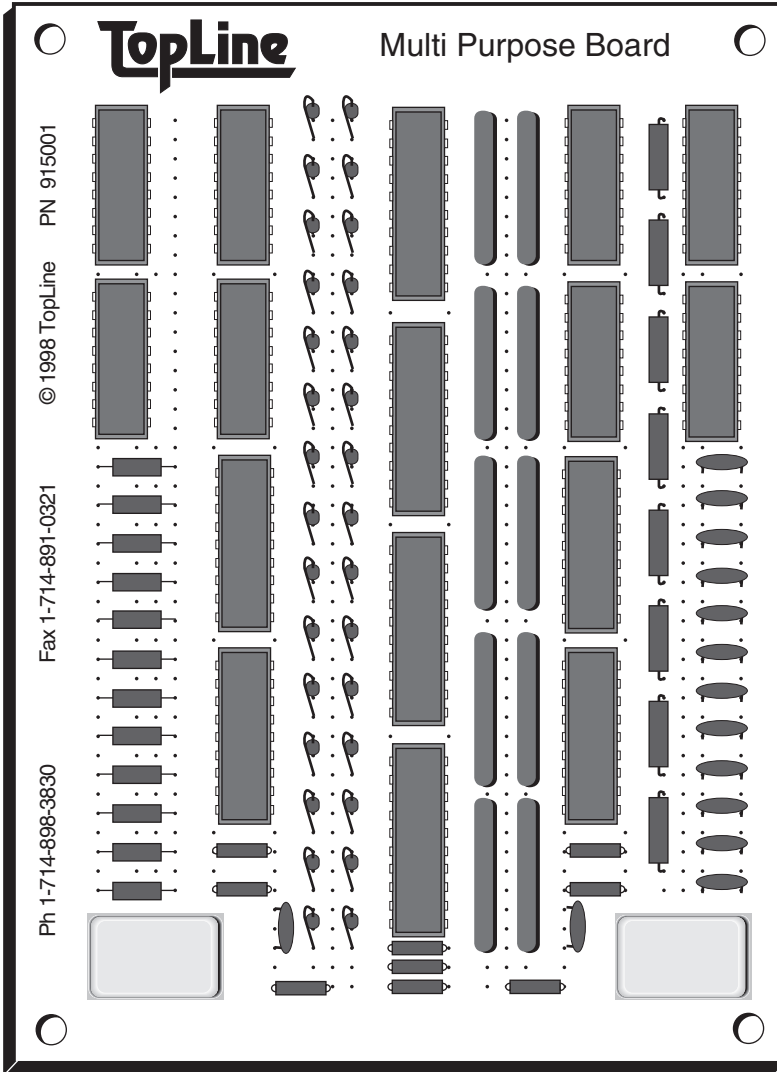

We supply the board and a wide assortment of components. This board has room for at least 200 different components. You decide where to insert the components.

Kits are available for machine or manual insertion.



FEATURES

- FR4 Board .062"
- Double Sided
- Tooling Holes .125"
- 920 Plated Throughholes
- Hole Pitch 0.10-inch

Actual Size: 4" x 5.5" (100 x 140mm)



KIT ORDERING INFORMATION

COMPONENT	 MANUAL ASSEMBLY				 MACHINE RUN	
	ORDER NUMBER	NUMBER	ORDER NUMBER	ORDER NUMBER	ORDER NUMBER	ORDER NUMBER
	916000	916025	916050	916100	915050	915100
	1 KIT	25 KITS	50 KITS	100 KITS	50 KITS	100 KITS
Board	1	25	50	100	50	100
8-PIN DIP	5	100	200	400	200	400
14-PIN DIP	5	100	200	400	200	400
16-PIN DIP	5	100	200	400	200	400
20-PIN DIP	5	50	100	200	100	200
SIP Resistor Network	10	100	200	400	200	400
Oscillator	2	40	100	200	100	200
Radial Capacitor	10	250	500	1000	500	1000
1/8 W Axial Resistor	50	1000	2500	5000	2500	5000
1/4 W Axial Resistor	50	1000	2500	5000	2500	5000
1/2 W Axial Resistor	20	1000	2000	4000	2000	4000

Lead Free (Pb-Free) Option

Description	Spare Board	1 Kit	10 Kits	25 Kits	50 Kits	100 Kits
Lead Free						
Sn – Tin	915002	916200	916210	916225	916250	916299
Ag – Silver	915006	916600	916610	916625	916650	916699
Cu – OSP	915008	916800	916810	916825	916850	916899
Au – Gold	915009	916900	916910	916925	916950	916999
Standard						
SnPb – HASL	915001	916000	916010	916025	916050	916100

Free Solder Paste Gerber + Parts Placement download www.topline.tv/GerbbersFree.cfm



ECONO KIT II

MIXED TECHNOLOGY FOR SOLDERING CERTIFICATION

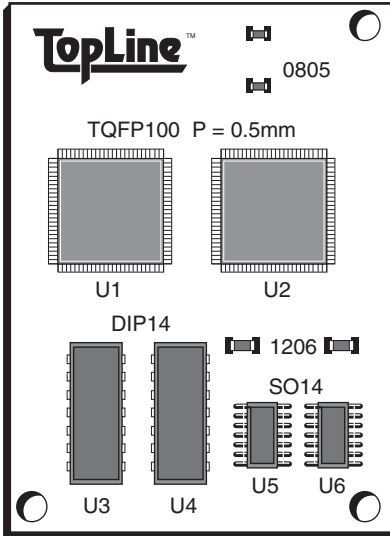

ACTUAL SIZE: 1.62" x 2.0" (41 x 51mm)

TopLine offers an economical, mixed technology kit with fine pitch. This kit is used by employment agencies for soldering certification.

FEATURES

- LPI Solder Mask
- FR4 Board .062"
- Single Sided
- Tooling Holes .125"
- Plated Throughholes



ECONO KIT II

MIXED TECHNOLOGY FOR SOLDERING CERTIFICATION



KIT ORDERING INFORMATION

		 MANUAL ASSEMBLY				
COMPONENT	PITCH	ORDER NUMBER	ORDER NUMBER	ORDER NUMBER	ORDER NUMBER	ORDER NUMBER
		938000 1 KIT	938010 10 KITS	938025 25 KITS	938050 50 KITS	938100 100 KITS
Board		1	10	25	50	100
LQFP100	0.5mm	2	20	50	100	200
SO14	50mil	2	20	50	100	200
DIP14	100mil	2	20	50	100	200
0805 Chip		2	20	50	100	250
1206 Chip		2	20	50	100	250

Note: Kits of 10, 25, 50 and 100 are bulk packed

Lead Free (Pb-Free) Option

Description	Spare Board	1 Kit	10 Kits	25 Kits	50 Kits	100 Kits
Lead Free						
Sn – Tin	938002	938200	938210	938225	938250	938299
Ag – Silver	938006	938600	938610	938625	938650	938699
Cu – OSP	938008	938800	938810	938825	938850	938899
Au – Gold	938009	938900	938910	938925	938950	938999
Standard						
SnPb – HASL	938001	938000	938010	938025	938050	938100

Free Solder Paste Gerber + Parts Placement download www.topline.tv/GerbbersFree.cfm



ECONO KIT III

MIXED TECHNOLOGY FOR SOLDERING CERTIFICATION

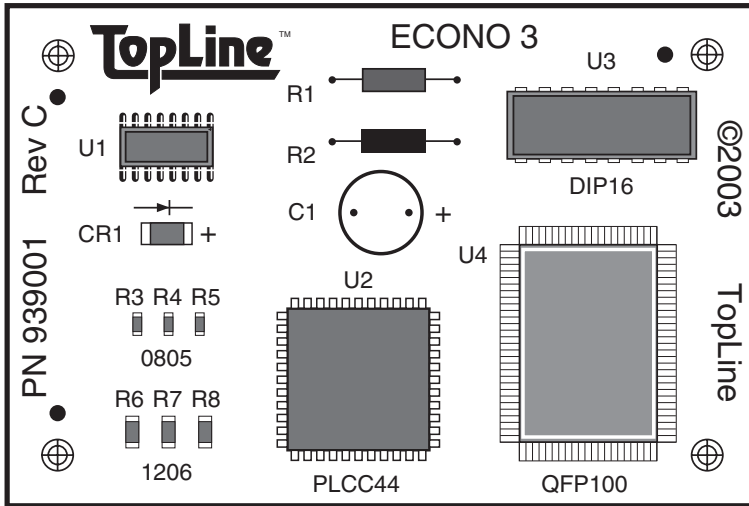

ACTUAL SIZE: 2" x 3" (50mm x 76mm)

TopLine offers an economical, mixed technology kit with popular components including fine pitch. This kit is used by employment agencies for soldering certification of assemblers.

FEATURES

- LPI Solder Mask
- FR4 Board .062"
- Single Sided
- Plated Throughholes
- Fiducial Marks
- Tooling Holes



ECONO KIT III

MIXED TECHNOLOGY FOR SOLDERING CERTIFICATION



KIT ORDERING INFORMATION

		 MANUAL ASSEMBLY				
COMPONENT	PITCH	ORDER NUMBER 939000 1KIT	ORDER NUMBER 939010 10 KITS	ORDER NUMBER 939025 25 KITS	ORDER NUMBER 939050 50 KITS	ORDER NUMBER 939100 100 KITS
Board		1	10	25	50	100
QFP100	0.65mm	1	10	25	50	100
PLCC44	1.27mm	1	10	25	50	100
SO16	1.27mm	1	10	25	50	100
DIP16	2.54mm	1	10	25	50	100
0805 Chip		3	30	75	150	300
1206 Chip		3	30	75	150	300
MELF		1	10	25	50	100
1/4W resistor	.5 inch	2	20	50	100	200
AL CAP	.2 inch	1	10	25	50	100

Note: Kits of 10, 25, 50 and 100 are bulk packed

Lead Free (Pb-Free) Option

Description	Spare Board	1 Kit	10 Kits	25 Kits	50 Kits	100 Kits
Lead Free						
Sn - Tin	939002	939200	939210	939225	939250	939299
Ag - Silver	939006	939600	939610	939625	939650	939699
Cu - OSP	939008	939800	939810	939825	939850	939899
Au - Gold	939009	939900	939910	939925	939950	939999
Standard						
SnPb - HASL	939001	939000	939010	939025	939050	939100

Free Solder Paste Gerber + Parts Placement download www.topline.tv/GerbbersFree.cfm



ECONO IV MIXED TECHNOLOGY RECERTIFICATION KIT

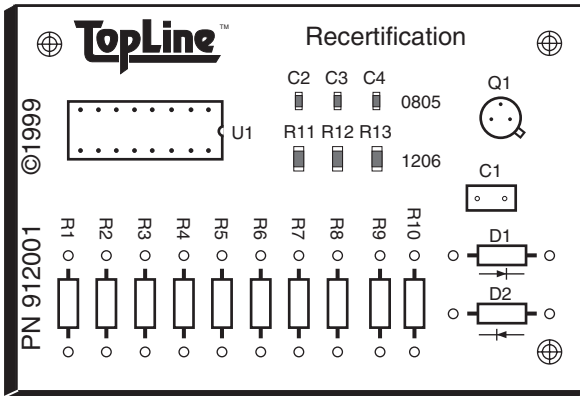

ACTUAL SIZE: 2" x 3" (50 x 76mm)

The Econo IV Kit offers an economical mixed technology kit with simple components. This kit is used for soldering re-certification of assemblers.

FEATURES

- LPI Solder Mask
- FR4 Board .062"
- Single Sided
- Plated Throughholes
- Tooling Holes

TopLine®



ECONO IV MIXED TECHNOLOGY RECERTIFICATION KIT



KIT ORDERING INFORMATION

		 MANUAL ASSEMBLY				
COMPONENT	PITCH	ORDER NUMBER	ORDER NUMBER	ORDER NUMBER	ORDER NUMBER	ORDER NUMBER
		912000 1KIT	912010 10 KITS	912025 25 KITS	912050 50 KITS	912100 100 KITS
Board		1	10	25	50	100
DIP16/18	IC	1	10	25	50	100
TO-5	Transistor	1	10	25	50	100
CK05	Capacitor	1	10	25	50	100
DO-35	Diode	2	20	50	100	200
0805 Chip	SMD	3	30	75	150	300
1206 Chip	SMD	3	30	75	150	300
1/4 W Resistor	Axial Lead	10	100	250	500	1000

Note: Kits of 10, 25, 50 and 100 are bulk packed.

Lead Free (Pb-Free) Option

Description	Spare Board	1 Kit	10 Kits	25 Kits	50 Kits	100 Kits
Lead Free						
Sn – Tin	912002	912200	912210	912225	912250	912299
Ag – Silver	912006	912600	912610	912625	912650	912699
Cu – OSP	912008	912800	912810	912825	912850	912899
Au – Gold	912009	912900	912910	912925	912950	912999
Standard						
SnPb – HASL	912001	912000	912010	912025	912050	912100

TopLine[®]



12 LAYER LEAD FREE THROUGHHOLE KIT DAISY CHAIN

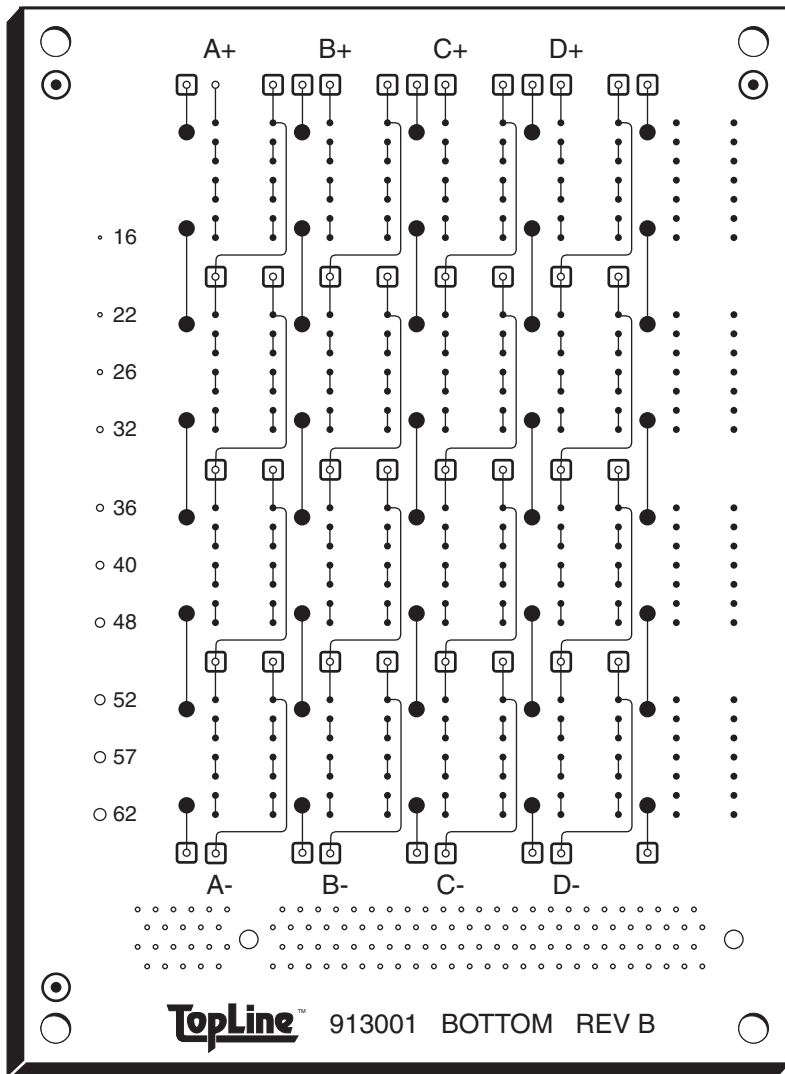

12-layer board designed with heat dissipating (thermal relief) inner layers, makes this board a challenge to solder. Boards available in 4 Lead Free finishes.

BOARD PLATING (Pb Free):

- Sn100 – White Tin (Immersion Tin)
- Ag - Immersion Silver
- Cu - OSP (Entek 106)
- Au - Gold Ni-Au (ENIG)
- (Electroless Nickel, Immersion Gold)

DAISY CHAIN

- DIP14
- Zero Ohm 1/4 W Resistors
- Go, No-Go Test Points

PLATED HOLES

Throughhole barrels with thermal relief are connected to all 10 inner layer copper ground planes for soldering capillary test.
10 holes with graduating sizes:
.016”- .062” (0.4mm ~1.6mm)

FEATURES

- LPI Solder Mask
- FR4 Board 0.10” (2.5mm) Thick
- Tg = 175°C 12 Layer
- Copper ground plane inner layers
- Tooling Holes
- Fiducials Marks
- 450 Plated Holes

Thermal Relief Wagon Wheel



Inner Layer PTH

Side View



Actual Size: 4.0” x 5.5” (100 x 140mm) 0.10” (2.5mm) thick

TopLine[®]



12 LAYER LEAD FREE THROUGHHOLE KIT DAISY CHAIN



KIT ORDERING INFORMATION

COMPONENT	NOTES	 MACHINE RUN				
		ORDER NUMBER 913216 16 KITS	ORDER NUMBER 913232 32 KITS	ORDER NUMBER 913248 48 KITS	ORDER NUMBER 913264 64 KITS	ORDER NUMBER 913296 96 KITS
*Board	Sn100	16	32	48	64	96
DIP14	Daisy Chain Test	256	512	768	1024	1536
DIP14	Non Daisy Chain	64	128	192	256	384
1/4 W Resistors	Zero Ohm	320	640	960	1280	1920
Connector AMP 1-5145154-2	120 Pin	16	32	48	64	96

*Note: Contact TopLine for combination kits with assortment of finishes: Sn, Ag, OSP, Au

Lead Free (Pb-Free) Option

Description	Spare Board	16 Kits	32 Kits	48 Kits	64 Kits	96 Kits
Lead Free						
Sn – Tin	913002	913216	913232	913248	913264	913296
Ag – Silver	913007	913616	913632	913648	913664	913696
Cu – OSP	913008	913816	913832	913848	913864	913896
Au – Gold	913009	913916	913932	913948	913964	913996

Free Solder Paste Gerber + Parts Placement download www.topline.tv/GerbersFree.cfm

NASA SOLDER TRAINING THROUGHHOLE KIT

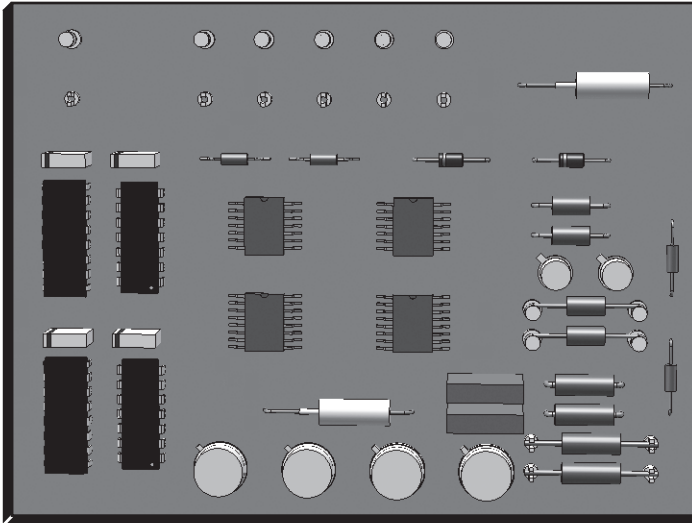

Actual Size: 4" x 5.5" (100 x 140mm)

The NASA kit includes a wide assortment of legacy throughhole and SMT components including flat packs and solder terminals.

FEATURES

- FR4 Board .062" SnPb HASL
- Double Sides
- Tooling Holes .125"
- Plated Throughholes
- Without Solder Mask

KIT CONTENTS

Item	Ref	Part Type or Description
1	U1, U2	DIP 14L (.3x.75)
2	U3, U4	DIP 16L (.3x.75)
3	U5, U6	FP 14L (Flat Pack)
4	U7, U8	FP 16L (Flat Pack)
5	U9, U10	TO-99
6	Q1, Q2	TO-5
7	Q3, Q4	TO-18
8	D1, D2	DO-35
9	C1, C2, C3, C4	CK05/CK06 (Molded Capacitor)
10	C5, C6	KK4 (Disc Capacitor)
11	C7, C8	CS2 (B-Case Tantalum)
12	R1, R2	RC05 1/8W Resistor (.015 wire)
13	R3, R4	RC05 1/8W Resistor (.015 wire)
14	R5, R6	RC07 1/4W Resistor (.025 wire)
15	R7, R8	RC07 1/4W Resistor
16	R9, R10	RC20 1/2W Resistor (.033 wire)
17	R11, R12	RC20 1/2W Resistor
18	E11-E16	Bifurcated Terminals .094 collar
19	E17-E22	Turret Terminals 0.125 collar

KIT ORDERING INFO

Tin-Lead PWB with components for customer to hand assemble	ORDER NUMBER	ORDER NUMBER	ORDER NUMBER
	979000	979010	979025
	1 Kit	10 Kits	25 Kits

Spare PWB

Order Number 979001

NON COLLAPSIBLE SOLDER BALL Sn96.5Ag3.5 WITH Cu & ELASTOMER CORE

DIA D	CORE	COPPER Cu	SOLDER S	PART NUMBER
80um	60um	3um	7um	NN2-SOL-80-3C7SA
110um	80um	5um	10um	NN2-SOL-110-5C10SA
200um	150um	5um	20um	NN2-SOL-200-5C20SA
200um	130um	5um	30um	NN2-SOL-200-5C30SA
250um	150um	10um	40um	NN2-SOL-250-10C40SA
262um	198um	7um	25um	NN2-SOL-262-7C25SA
310um	210um	10um	40um	NN2-SOL-310-10C40SA
311um	235um	8um	30um	NN2-SOL-311-8C30SA
350um	264um	10um	33um	NN2-SOL-350-10C33SA
500um	400um	15um	35um	NN2-SOL-500-15C35SA
650um	550um	20um	30um	NN2-SOL-650-20C30SA
910um	790um	20um	40um	NN2-SOL-910-20C40SA

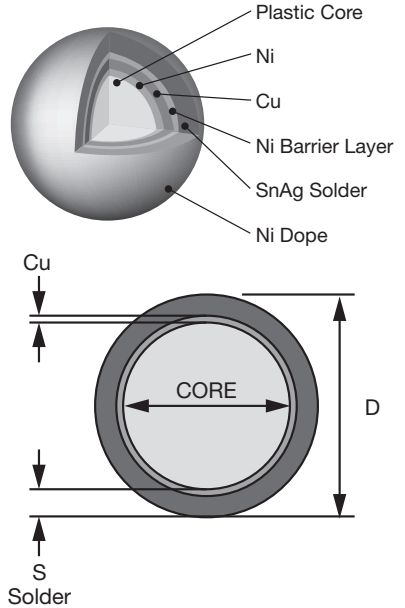

APPLICATIONS:

DIMENSIONALLY STABLE. SOLDERABLE. DURABLE.
 USE TO SUPPORT & INTERCONNECT MODULES TO MOTHER BOARD.
 NON-COLLAPSIBLE TOP MOUNTED BGA/CSP (PoP) PACKAGE.
 SOLDERABLE SPACER/STANDOFF. FR4, GLASS, CERAMIC, BT

CCGA SOLDER COLUMNS

FIGURE	COLUMN DIAMETER	LENGTH	MATERIALS
1	0.020" 0.51mm	0.087" 2.21mm	Pb90/Sn10
2	0.020" 0.51mm	0.087" 2.21mm	Pb80/Sn20 Cu Wrap
	0.020" 0.51mm	0.100" 2.54mm	
	0.022" 0.56mm	0.087" 2.21mm	
	0.022" 0.56mm	0.100" 2.54mm	
3	0.020" 0.51mm	0.050" 1.27mm	Be Cu Micro-Coil Spring



FIG. 1

**Pb90/Sn10
PLAIN**

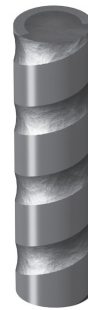

FIG. 2

**Pb80/Sn20
Cu WRAP**



FIG. 3

**BE CU
SPRING**

* Licensed from NASA under U.S. Patent Application Serial No. 13/800,692



OPEN CAVITY M-QFN ATTACH YOUR DIE

Open Tool Packages

Visit www.MirrorSemi.com

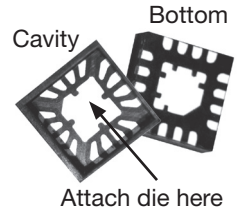

ORDERING INFORMATION

BODY D/E SIZE SQ	NBR LEAD		DIE PAD mm	CAVITY PACKAGE PART NUMBER	TRAY QTY
	LEADS	PITCH			
3mm	8	0.65mm	1.4 SQ	M-QFN8W.65	100
3mm	12	0.5mm	1.4 SQ	M-QFN12W.5	100
3mm	16	0.5mm	1.4 SQ	M-QFN16W.5	100
4mm	16	0.65mm	2.4 SQ	M-QFN16W.65	64
4mm	20	0.5mm	2.4 SQ	M-QFN20W.5	64
4mm	24	0.5mm	2.4 SQ	M-QFN24W.5	64
5mm	32	0.5mm	3.4 SQ	M-QFN32W.5	36
5mm	40	0.4mm	3.4 SQ	M-QFN40W.4	36
6mm	40	0.5mm	4.4 SQ	M-QFN40W.5	25
6mm	48	0.4mm	4.4 SQ	M-QFN48W.4	25
7mm	48	0.5mm	5.4 SQ	M-QFN48W.5	81
8mm	56	0.5mm	6.0 SQ	M-QFN56W.5	64
9mm	64	0.5mm	7.0 SQ	M-QFN64W.5	49
10mm	72	0.5mm	8.0 SQ	M-QFN72W.5	49
12mm	80	0.5mm	9.0 SQ	M-QFN80W.5	36
12mm	100	0.4mm	9.0 SQ	M-QFN100W.4	36

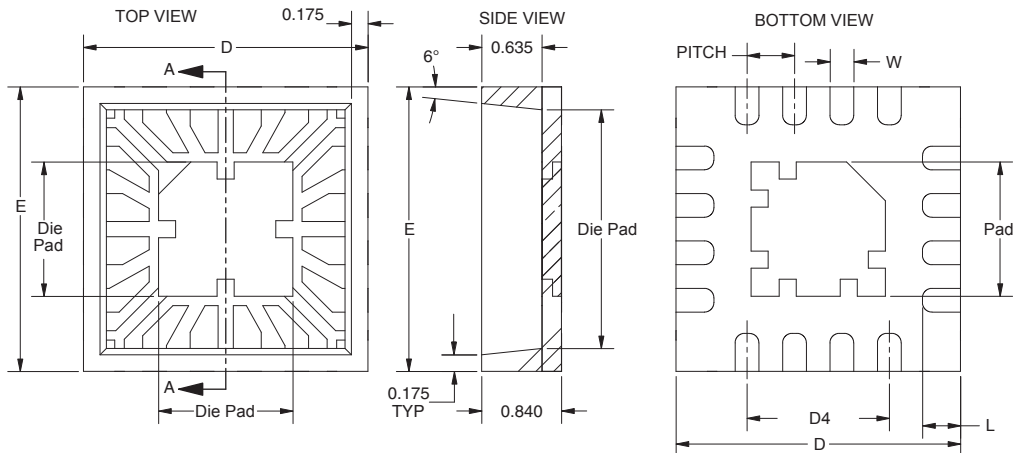

INFO

Open cavity. Attach and wire bond your own die.

Wire bondable. Applications: MEMS, RF Microwave. Fabless prototype, Socket probing

Visit www.MirrorSemi.com for drawings



OPEN CAVITY M-QFN ATTACH YOUR DIE

Visit www.MirrorSemi.com

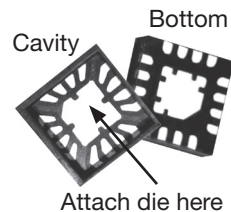

ORDERING INFORMATION

BODY D/E SIZE SQ	NBR. LEAD		DIE PAD mm	CAVITY PACKAGE PART NUMBER	FLAT LID PART NBR (OPTIONAL)
	LEADS	PITCH			
3mm	20	0.4mm	1.4 SQ	M-QFN20W.4	T-LID3-BLACK
4mm	12	0.65mm	2.4 SQ	M-QFN12W.65	T-LID4-BLACK
4mm	12	0.8mm	2.4 SQ	M-QFN12W.8	T-LID4-BLACK
4mm	28	0.4mm	2.4 SQ	M-QFN28W.4	T-LID4-BLACK
5mm	16	0.8mm	3.4 SQ	M-QFN16W.8	T-LID5-BLACK
5mm	20	0.65mm	3.4 SQ	M-QFN20W.8	T-LID5-BLACK
5mm	20	0.8mm	3.4 SQ	M-QFN20W.8	T-LID5-BLACK
5mm	24	0.65mm	3.4 SQ	M-QFN24W.65	T-LID5-BLACK
5mm	28	0.5mm	3.4 SQ	M-QFN28W.5	T-LID5-BLACK
5mm	36	0.4mm	3.4 SQ	M-QFN36W.4	T-LID5-BLACK
6mm	28	0.65mm	4.4 SQ	M-QFN28W.65	T-LID6-BLACK
6mm	36	0.5mm	4.4 SQ	M-QFN36W.5	T-LID6-BLACK
7mm	28	0.8mm	5.4 SQ	M-QFN28W.8	T-LID7-BLACK
7mm	32	0.65mm	5.4 SQ	M-QFN32W.65	T-LID7-BLACK
7mm	44	0.5mm	5.4 SQ	M-QFN44W.65	T-LID7-BLACK
8mm	52	0.5mm	6.4 SQ	M-QFN52W.5	T-LID8-BLACK
9mm	72	0.4mm	7.0 SQ	M-QFN72W.4	T-LID9-BLACK
10mm	68	0.5mm	8.2 SQ	M-QFN68W.5	T-LID10-BLACK
10mm	88	0.4mm	8.2 SQ	M-QFN88W.4	T-LID10-BLACK

Made by
TANAKA

GSA SERIES Gold 4N (Au) BONDING WIRE



ORDERING INFORMATION

ø DIAMETER	BREAKING LOAD (GF)	EL (%)	LENGTH METERS	PART NUMBER	ORDER NUMBER
ø 15μm (ø 0.6mil)	2.5~5.3 gf	1.0~6.0%	100m	GSA-15A100	300151
			300m	GSA-15A300	300153
			500m	GSA-15A500	300155
ø 18μm (ø 0.7mil)	3.6~7.6 gf	1.0~6.0%	100m	GSA18A100	300181
			300m	GSA18A300	300183
			500m	GSA18A500	300185
ø 20μm (ø 0.8mil)	4.4~9.4 gf	1.0~7.0%	100m	GSA20A100	300201
			300m	GSA20A300	300203
			500m	GSA20A500	300205
ø 25μm (ø 1.0mil)	7.0~14.7 gf	1.0~7.0%	100m	GSA25A100	300251
			300m	GSA25A300	300253
			500m	GSA25A500	300255
ø 30μm (ø 1.2mil)	10.0~21.1 gf	1.5~8.5%	100m	GSA30A100	300301
			300m	GSA30A300	300303
			500m	GSA30A500	300305
ø 32μm (ø 1.25mil)	11.0~23.0 gf	1.5~8.5%	100m	GSA32A100	300321
			300m	GSA32A300	300323
			500m	GSA32A500	300325
ø 33μm (ø 1.3mil)	12.1~25.5 gf	1.5~8.5%	100m	GSA33A100	300331
			300m	GSA33A300	300333
ø 38μm (ø 1.5mil)	16.0~33.8 gf	1.5~8.5%	100m	GSA38A100	300381
			300m	GSA38A300	300383
ø 50μm (ø 2.0mil)	27.6~58.3 gf	1.5~8.5%	100m	GSA50A100	300501
			300m	GSA50A300	300503

www.Tanakawire.com for Cu, Ag, Al and more Au bonding wire

Made by
TANAKA

ALUMINUM AL-1%Si BONDING WIRE



ORDERING INFORMATION

ø DIAMETER	BREAKING LOAD (gf)	EL (%)	LENGTH METERS	PART NUMBER	ORDER NUMBER
ø 18µm (ø 0.7mil)	6.0~7.5 gf	0.5~4.5%	100m 300m	TABN-18A100 TABN-18A300	403181 403183
ø 20µm (ø 0.8mil)	8.0~10 gf	0.5~4.5%	100m 300m	TABN-20A100 TABN-20A300	403201 403203
ø 25µm (ø 1.0mil)	13~15 gf	0.5~4.5%	100m 300m	TABN-25A100 TABN-25A300	403251 403253
ø 30µm (ø 1.2mil)	17~19 gf	0.5~4.5%	100m 300m	TABN-30A100 TABN-30A300	403301 403303
ø 32µm (ø 1.25mil)	19~21 gf	0.5~4.5%	100m 300m	TABN-32A100 TABN-32A300	403321 403323
ø 38µm (ø 1.5mil)	31~44 gf	0.5~6.0%	100m 300m	TABN-38A100 TABN-38A300	403381 403383
ø 50µm (ø 2.0mil)	147~53 gf	0.5~6.0%	100m 300m	TABN-50A100 TABN-50A300	403501 403503
ø 80µm (ø 3.0mil)	130~150 gf	0.5~6.0%	100m 300m	TABN-80A100 TABN-80A300	403801 403803

POWER ALUMINUM

ø 100µm (ø 4mil)	50~80 gf	10~30%	100m 500m	TANW-100P100 TANW-100P500	405001 405005
ø 125µm (ø 5mil)	60~120 gf	10~30%	100m 500m	TANW-125P100 TANW-125P500	405011 405015
ø 150µm (ø 6mil)	100~200 gf	10~30%	100m 500m	TANW-150P100 TANW-150P500	405021 405025
ø 200µm (ø 8mil)	140~200 gf	9~25%	100m 500m	TANW-200P100 TANW-200P500	405041 405045
ø 250µm (ø 10mil)	210~300 gf	10~30%	100m 500m	TANW-250P100 TANW-250P500	405051 405055

www.Tanakawire.com for Cu, Ag, Al and more Au bonding wire

SILICON TEST DIE FOR BONDING PRACTICE DAISY CHAIN & ISOLATED

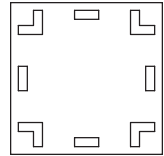

ORDERING INFORMATION

FIG.	CIRCUIT	DIE SIZE	PAD SIZE	NBR PADS	TRAY QTY	PART NUMBER
Fig. 1	Daisy Chain	1.0x1.0mm	60x160µm	8 Pair	100	TD8-1.0-DC
Fig. 2	Daisy Chain	2.5x2.5mm	60x160µm	16 Pair	100	TD16-2.5-DC
Fig. 3	Daisy Chain	4.0x4.0mm	60x360µm	24 Pair	64	TD24-4.0-DC
Fig. 4	Isolated	1.0x1.0mm	60µm SQ	16	100	TD16-1.0-ISO
Fig. 5	Isolated	2.5x2.5mm	60µm SQ	32	100	TD32-2.5-ISO
Fig. 6	Isolated	4.0x4.0mm	60µm SQ	48	64	TD48-4.0-ISO
Fig. 7	Differential Pair	1.0x1.0mm	60x160µm	2 + GND	100	TD2-1.0-DIF
Fig. 8	Differential Pair	2.5x2.5mm	60x160µm	2 + GND	100	TD2-2.5-DIF
Fig. 9	Differential Pair	4.0x4.0mm	60x160µm	2 + GND	64	TD2-4.0-DIF
Fig. 10	Fully Plated	1.0x1.0mm	900µm SQ	1	100	TD1-1.0-BUS
Fig. 11	Fully Plated	2.5x2.5mm	2400µm SQ	1	100	TD1-2.5-BUS
Fig. 12	Fully Plated	4.0x4.0mm	3900µm SQ	1	64	TD1-4.0-BUS

Not to Scale

Fig. 1
TD8-1.0DC

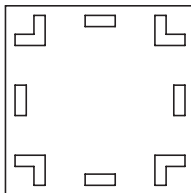

Fig. 2
TD16-2.5-DC

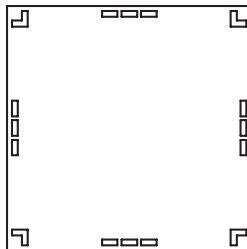
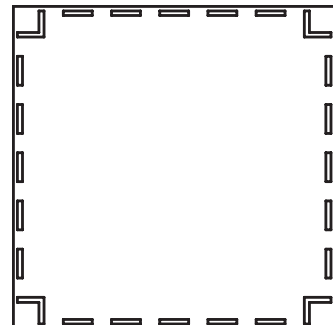

Fig. 3
TD24-4.0-DC



**I
N
F
O**

Die Material is Silicon (Si) 250µm (10mil) thick.
Metallization 1.0µm Aluminum (Al) over 0.75µm SiO₂
Wire bondable with Gold (Au) or Aluminum (Al) wire.
Applications: Wire Bonding Practice or for RF / impedance characterization trials.

SILICON TEST DIE FOR BONDING PRACTICE OUTLINE DRAWINGS

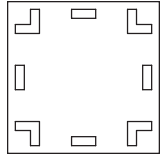

ORDERING INFORMATION

Not to Scale

Fig. 4
TD16-1.0-ISO

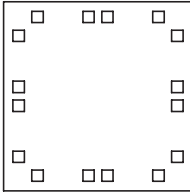

Fig. 5
TD32-2.5-ISO

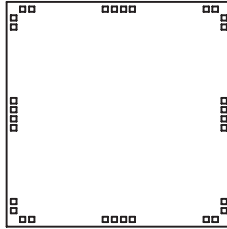

Fig. 6
TD48-4.0-ISO

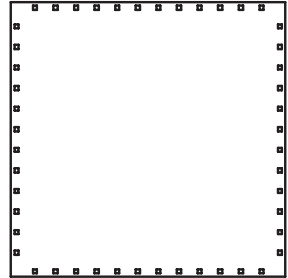

Fig. 7
TD2-1.0-DIF

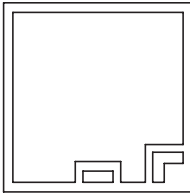

Fig. 8
TD2-2.5-DIF

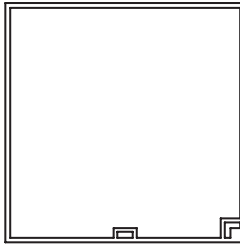

Fig. 9
TD2-4.0-DIF

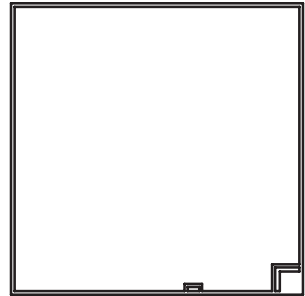

Fig. 10
TD1-1.0-SUS

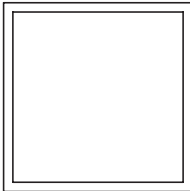

Fig. 11
TD1-2.5-BUS

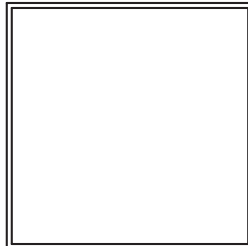
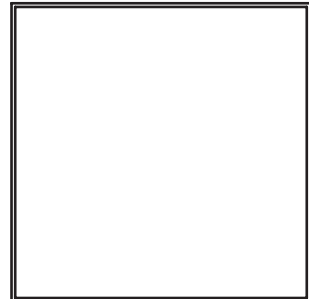

Fig. 12
TD1-4.0-BUS



INTERNATIONAL DISTRIBUTORS

EUROPE

BENELUX, BELGIUM, NETHERLANDS

Rotec

Tel + 32 (0)14 40 21 52

E-mail info@rotec.be

www.rotec.be

DENMARK

ETRONIX

Tel + 46 70 535 4203

E-mail Kenneth.Hedman@etronixAB.se

www.etronixAB.se

FINLAND

Uptech Finland

Tel + 358-40-5479 338

E-mail jarno.pyoria@uptech.fi

FRANCE

Peri-Cles

Tel + 33-01-6055.50.15

E-mail peri-cles@orange.fr

www.peri-cles.com

FRANCE

ATOO electronics

Tel + 33-02-99.08.01.90

E-mail info@atoo-electronics.com

www.atoo-electronics.com

GERMANY

Factronix

Tel + 49-8153-90664-0

E-mail office@factronix.com

www.factronix.com

GERMANY

Weidinger

Tel + 49-(0)8141/3636-0

E-mail info@weidinger.eu

www.weidinger.eu

IRELAND

IPT Limited

Tel + 351-21-4232233

E-mail info@ipt.ie

www.iptelectronics.com

ITALY (NORTH)

CepeItalia

Tel +39-02-4073747

E-mail info@cepeitalia.it

ITALY (SOUTH)

CEPE Forniture

Tel +39-075.95.61.86

E-mail cepeelettronica@virgilio.it

NORWAY

ETRONIX

Tel + 46 70 535 4203

E-mail Kenneth.Hedman@etronixAB.se

www.etronixAB.se

POLAND

SEMICON

Tel + 48-22-615-6431

E-mail info@semicon.com.pl

www.semicon.com.pl

RUSSIA

Ostec Enterprise

Tel +7 (494) 788-4444

E-mail Alexander.Votintsev@ostec-smt.ru

RUSSIA

New Technologies

Tel +7 (812) 448-53-24

E-mail mail@tecnew.ru

www.tecnew.ru

SPAIN

Necten

Tel + 34-91-916-942-409

E-mail necten@necten.com

SWEDEN

ETRONIX

Tel + 46 (0) 70 535 4203

E-mail Kenneth.Hedman@etronixAB.se

www.etronixAB.se

SWITZERLAND

Hilpert

Tel + 41-56-483-2525

E-mail office@hilpert.ch

www.hilpert.ch

UNITED KINGDOM

Kaisertech

Tel + 44-023-8065-0065

E-mail sales@kaisertech.co.uk

www.kaisertech.co.uk

TURKEY

Esman Elektronik

Tel + 90-216-516-02 20

E-mail esman@esmanelektronik.com

INTERNATIONAL DISTRIBUTORS

ASIA & PACIFIC

AUSTRALIA

Machinery Forum (VIC)

Melbourne

Tel + 61-3-9497-3633

E-mail

machinery@machineryforum.com.au

AUSTRALIA

Machinery Forum (NSW)

Sydney

Tel + 61-2-9638-1566

E-mail

machinery@mafosyd.com.au

CHINA AND HONG KONG

Borison Electronics

Tel + 852-2687-0948

E-mail TopLine@borison.com

www.borison.com

CHINA-SHANGHAI

Jamron

Tel + 86-21-51097866

E-mail info@jamron.com

www.jamron.com

CHINA SHANGHAI

Dou Yee

Tel + 86-21-5899 4619

E-mail chinkc@douyee.com.cn

INDIA

EMST Technologies

Tel + 91-20-3250 1000

E-mail contact@emstonline.com

ISRAEL

G-Suit

Tel + 972-8-910-8878

E-mail G-Suit@TopLine.tv

JAPAN

ADY

Tel + 81-06-6397-0412

E-mail ADY@TopLine.tv

www.ADY-JP.com

KOREA

Jin Trading

Tel + 82-031-499-5633

E-mail jeong6651@naver.com

www.jtco.co.kr

MALAYSIA

Dou Yee

Tel + 65-6444-2678

E-mail marketing@douyee.com

www.douyee.com

SINGAPORE

Dou Yee

Tel + 65-6444-2678

E-mail marketing@douyee.com

www.douyee.com

THAILAND

Dou Yee

Tel + 65-6444-2678

E-mail marketing@douyee.com

www.douyee.com

TAIWAN

Zinby

Tel + 886-2-8228-0880

E-mail sales1@zinby.com.tw

AFRICA

SOUTH AFRICA

Test & Rework

Tel +27 -11- 704-6677

E-mail sales@testandrework.co.za

AMERICAS

UNITED STATES & CANADA

TopLine

Tel + 1-800-776-9888

Fax + 1-478-451-3000

E-mail sales@topline.tv

www.topline.tv

MEXICO

TopLine

Tel + 1-478-451-5000

E-mail sales@topline.tv

BRAZIL

Intract

Tel + 55-11-3392-6222

E-mail eletro@intract.com.br

www.intract.com.br

ARGENTINA

TopLine

Tel +1 - 478 - 451-5000

E-mail sales@topline.tv

CHILE

POIROT

Tel + 56-2-688-4466

E-mail Luis.Lund@poirot.cl



UNIVERSAL QFP LEAD STRAIGHTENER REWORK TOOL





QFP Lead Straightener

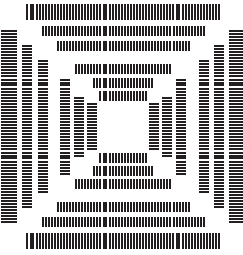

0.4mm Pitch

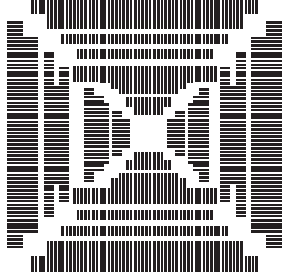

0.5mm Pitch

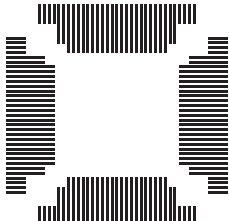

0.635mm Pitch

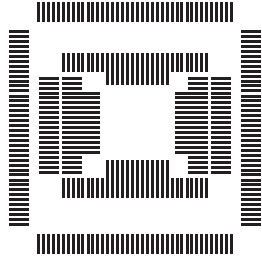

0.65mm Pitch

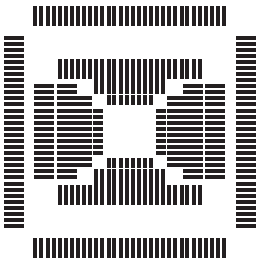

0.8mm Pitch

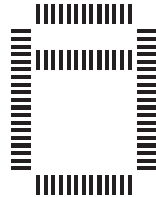

1.0mm Pitch

©2003 TopLine P/N 900000 REV A Design Patent D512,970

Actual Size: 4" x 5.5" (100 x 140mm) .048" (1.2mm) thick

Low cost Universal QFP Lead Straightener handles all QFP, TQFP and LQFP with pitch of 0.4mm to 1.0mm.

Complete set includes all template patterns.

Use standard hand tools such as dental picks and tweezers to adjust leads of QFP to match recessed template slots.

Great for rework and recovery of expensive QFP, TQFP and LQFP. Also use for incoming inspection.

Conductive heavy duty stainless steel construction - precision coplanarity. For use on benchtop.

Lead Count and Pitch Includes:

0.4mm	0.5mm	0.65mm	0.8mm
64L	32L	52L	32L
80L	48L	80L	44L
120L	64L	100L	64L
128L	80L	144L	80L
176L	100L	160L	120L
216L	128L		128L
256L	144L	0.635mm	
	160L	84L	1.0mm
	176L	100L	44L
	184L	132L	52L
	208L		64L
	240L		

Order Number: 900000

Design Patent D512,970