

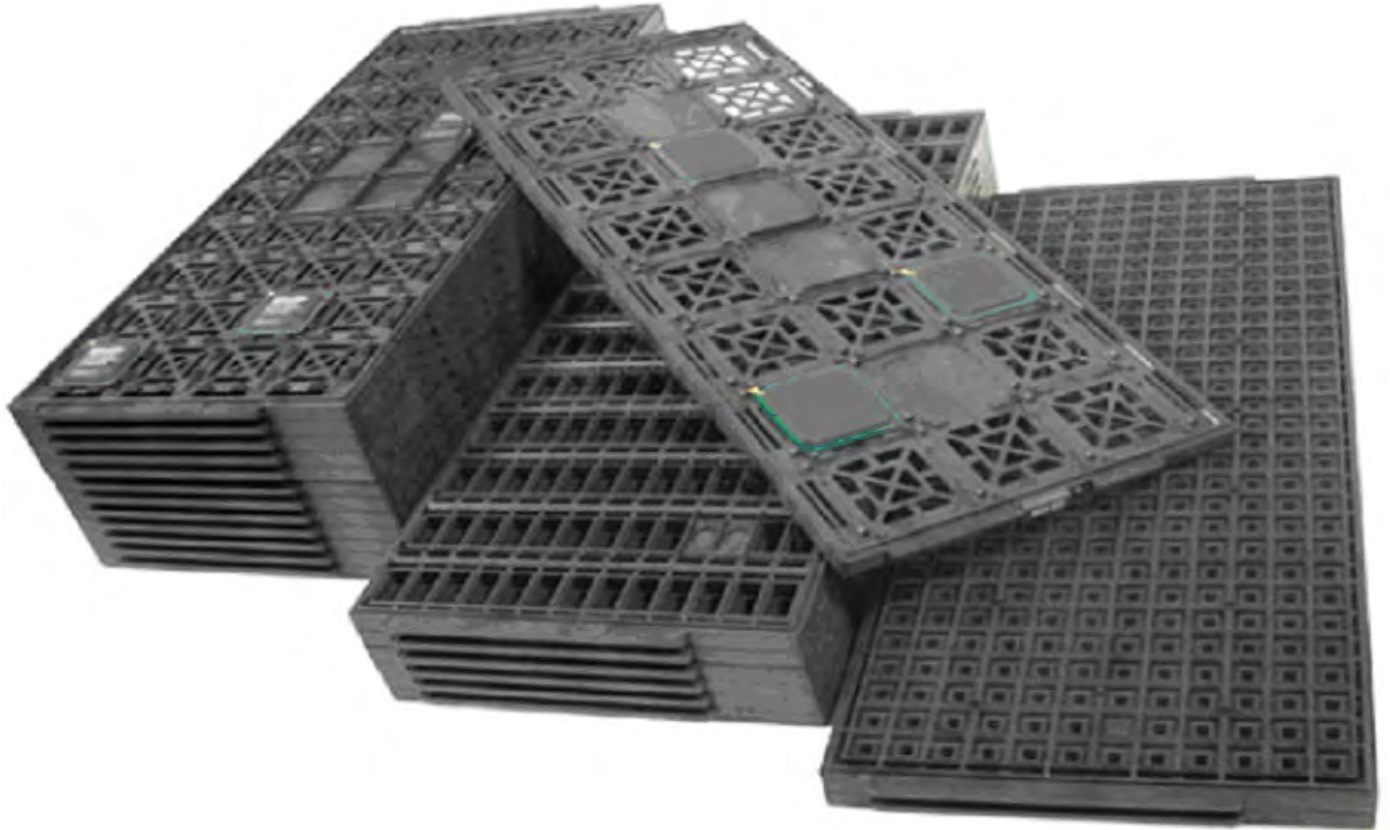

Small Orders Welcome



Tray Catalog

JEDEC and Waffle Packs

Product Guide

2026-A

Contact:

info@TopLine.tv

Tel 1-800-776-9888

www.TopLine.tv/tray.html

Find it Fast

www.TopLine.tv/tray.html



QFP
Quad Flat Pack
Page 4



TQFP & LQFP
Thin Quad Flat Pack
Page 5

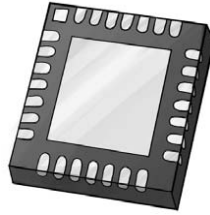

QFN Square
Quad Flat No Lead
Page 6



QFN Rectangle
Quad Flat No Lead
Page 7



**SO, SOL, SOP, SSOP,
TSSOP, MSOP**
Page 8-9



TSOP TYPE 1
Page 10



TSOP TYPE 2
Page 11

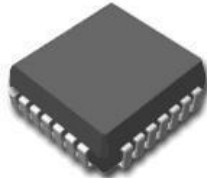

PLCC
J-LEAD
Page 12

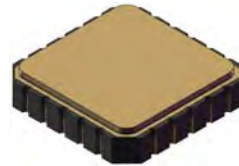

LCC
Leadless Chip Carrier
Page 13



BGA
Ball Grid Array
Page 13-20



Universal Cover Tray
Page 21



ESD Tray Straps
Page 22



Color Tray Clips
Page 23

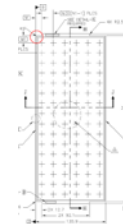

Pick & Place
Dimensions
Page 24



Custom Tray
Questionnaire
Page 25



2" Waffle Packs
Page 26-30



JIG-TRAY
Convert 2" Waffle
to JEDEC Outline
Page 31



4" Waffle Packs
Page 32 ~ 36



JIG-TRAY
Convert 4" Waffle
to JEDEC Outline
Page 37

Small Orders
Welcome

**Thousands
of trays
In Stock**

Where to Buy
Page 38-39



About Trays

www.TopLine.tv/tray.html

Contact: info@TopLine.tv
Tel 1-800-776-9888

About TopLine:

TopLine stocks thousands of JEDEC trays and waffle packs. We welcome small orders from universities, microelectronic labs and small volume users. Easy to order. Contact us today.

JEDEC Trays:

JEDEC trays provide safe handling, transport and storage of Integrated Circuits (ICs), modules and other components. JEDEC trays are made from ESD safe molding compounds. JEDEC trays are strong and protect its contents.

JEDEC Size

JEDEC matrix trays are 12.7 x 5.35 inches (322.6 x 136 mm). Low profile trays (6.35mm thick) accommodate 90% of all components, such as BGA, CSP, QFP, TQFP, QFN, TSO P and SOIC. High profile (10.16mm and 12.7mm thick) trays are available to hold tall components such as PLCC, CERQUAD, PGA (Pin Grid Arrays), modules, and PCBA assemblies.

Pin 1 Orientation

Orient JEDEC trays with the 45-degree chamfer (Pin 1) in the upper left corner of the tray. See page 24. Pick and place dimensions are available on line: www.TopLine.tv/tray.html

Tray Covers & Straps

An empty JEDEC tray (without components) may serve as the cover tray. Alternatively, use a universal COVERTRAY. See page 21. Safe stacking should be limited to 5 to 6 trays. Secure with conductive rubber bands or tray straps. See page 22.

Custom JEDEC trays

TopLine makes custom JEDEC trays for safe storage and transit of odd-shaped components, tall components, and PCBA assemblies. Complete the Custom Tray Questionnaire. Page 25.

Waffle Packs

2" and 4" waffle packs (IC Chip Trays) are perfect for safe storage and transit of thin die and tiny parts. Send to TopLine a sketch of your chip for assistance.

Cover Tray and Clips

TopLine has a wide variety of covers and clips for securing Waffle Packs. Add a Tyvek® or film insert between the chip and the cover for additional protection.

Tall Components

Special Extension Covers are available for tall components. Contact TopLine for assistance when needing waffle packs for tall (high) components.

ESD Safe

Waffle packs and covers are made from black ESD conductive or static dissipative materials.

Convert Waffle Packs into JEDEC

TopLine offers JIG-TRAYS to convert 2" and 4" waffle packs into JEDEC for mat trays for pick and place. See page 31 and 37.

Technical Support:

Contact TopLine for technical support and questions for applications involving special needs. We look forward to assisting you. Email info@TopLine.tv Or call 1-800-776-9888

Contact:

TopLine Corporation

95 Highway 22 W.
Milledgeville, GA 31061 USA

Tel: +1-800-776-9888

Email: info@TopLine.tv

www.TopLine.tv/tray.html

We accept credit cards:



Ready to assist you.

QFP Body Size	Device Thickness	QTY Pockets	MATRIX Row-Column	JEDEC Reference	Tray Part Number
10 x 10mm	2.0mm	96	6 x 16	CS-004AA	QTRAY10mm-6x16
14 x 14mm	2.0mm	84	6 x 14	CS-004AB	QTRAY14mm-6x14
14 x 14mm	2.7mm	84	6 x 14	CS-004AB	QTRAY14mm-6x14-2.7
14 x 20mm	2.7mm	66	6 x 11	CS-004AC	QTRAY14x20mm-6x11
28 x 28mm	3.6mm	24	3 x 8	CS-004AD	QTRAY28mm-3x8
32 x 32mm	3.8mm	24	3 x 8	CS-004AE	QTRAY32mm-3x8
40 x 40mm	3.8mm	12	3 x 4	CS-004AF	QTRAY40mm-3x4

BQFP Body Size	Device Thickness	QTY Pockets	MATRIX Row-Column	JEDEC Reference	Tray Part Number
19 x 19mm	3.0mm	55	5 x 11	CS-002AC	BQTRAY100-5x11
24 x 24mm	3.3mm	36	4 x 19	CS-002AD	BQTRAY132-4x19

Component At-A-Glance

QFP SQUARE



QFP RECTANGULAR



BQFP- BUMPER



Good to Know:

QFP Quad Flat Pack components.
 Also known as MQFP (Metric QFP) or PQFP (Plastic QFP)
 BQFP are special Bumper Quad Flat Pack.
 For assistance, send the component manufacturer datasheet to TopLine.

INFO

- Note 1: JEDEC Standard Outline 136 x 315mm (322.5mm with end tabs)
- Note 2: Standard tray color: Black conductive or dissipative molding compound ESD safe.
- Note 3: Up to five JEDEC trays may be stacked with empty tray on top as a cover.
- Note 4: Secure with 3x ESD Velcro straps or heavy duty black conductive rubber bands (4.5" x 0.5")
- Note 5: Optional tray clips available in 11 colors for quick visual identification: Sorting, aging and testing.
- Note 6: Tray Temperature rating 140°C or 150°C recommended for component dry baking.
- Note 7: High temperature 180°C available special order

LQFP Body Size	Device Thickness	QTY Pockets	MATRIX Row-Column	JEDEC Reference	Tray Part Number
5 x 5mm	1.4mm	360	12 x 30	CS-007AA	LQTRAY5mm-12x30
7 x 7mm	1.4mm	250	10 x 25	CS-007AB	LQTRAY7mm-6x14
10 x 10mm	1.4mm	160	8 x 20	CS-007AC	LQTRAY10mm-8x20
12 x 12mm	1.4mm	119	7 x 17	CS-007AJ	LQTRAY12mm-7x17
14 x 14mm	1.4mm	90	6 x 15	CS-007AE	LQTRAY14mm-6x15
14 x 20mm	1.4mm	72	6 x 12	CS-007AF	LQTRAY14X20mm-6x12
20 x 20mm	1.4mm	60	5 x 12	CS-007AG	LQTRAY20mm-5x12
24 x 24mm	1.4mm	40	4 x 10	CS-007AH	LQTRAY24mm-4x10
28 x 28mm	1.4mm	36	4 x 9	CS-007AJ	LQTRAY28mm-4x9

TQFP Body Size	Device Thickness	QTY Pockets	MATRIX Row-Column	JEDEC Reference	Tray Part Number
5 x 5mm	1.4mm	360	12 x 30	CS-007AA	TQTRAY5mm-12x30
7 x 7mm	1.4mm	250	10 x 25	CS-007AB	TQTRAY7mm-6x14
10 x 10mm	1.4mm	160	8 x 20	CS-007AC	TQTRAY10mm-8x20
12 x 12mm	1.4mm	119	7 x 17	CS-007AJ	TQTRAY12mm-7x17
14 x 14mm	1.4mm	90	6 x 15	CS-007AE	TQTRAY14mm-6x15
20 x 20mm	1.4mm	60	5 x 12	CS-007AG	TQTRAY20mm-5x12

Component At-A-Glance

LQFP
1.4mm High



LQFP RECTANGULAR
1.4mm High



TQFP
1.0mm High



Good to Know:

LQFP Low Quad Flat Pack components are 1.4mm thick.
 TQFP Thin Quad Flat Pack components are 1.0mm thick.
 For assistance, send the component manufacturer datasheet to TopLine.

INFO

- Note 1: JEDEC Standard Outline 136 x 315mm (322.5mm with end tabs).
- Note 2: Standard tray color: Black conductive or dissipative molding compound ESD safe.
- Note 3: Five to size JEDEC trays may be safely stacked with empty tray on top as a cover.
- Note 4: Secure with 3x ESD Velcro straps or heavy duty black conductive rubber bands (4.5"L x 0.5"W).
- Note 5: Colored tray clips are available in 11 colors for quick visual identification: Sorting, aging and testing.
- Note 6: Tray Temperature rating 140°C or 150°C recommended for component dry baking.
- Note 7: High temperature 180°C available on special order.

QFN Square	Device Thickness	QTY Pockets	MATRIX Row-Column	JEDEC Reference	Tray Part Number
3 x 3mm	1.0mm	490	14 x 35	CO-34AA	QFNTRAY3mm-14x35
3 x 3mm	1.0mm	624	16 x 39	High Capacity	QFNTRAY3mm-16x39
4 x 4mm	1.0mm	490	14 x 35	CO-34AA	QFNTRAY4mm-14x35
4 x 4mm	0.9mm	810	18 x 45	High Capacity	QFNTRAY4mm-18x45
5 x 5mm	1.0mm	490	14 x 35	CO-34AA	QFNTRAY5mm-14x35
5 x 5mm	1.0mm	576	16 x 36	High Capacity	QFNTRAY5mm-16x36
6 x 6mm	1.0mm	490	14 x 35	CO-34AA	QFNTRAY6mm-14x35
7 x 7mm	1.0mm	260	10 x 26	CO-34AB	QFNTRAY7mm-10x26
7 x 7mm	1.0mm	416	13 x 32	High Capacity	QFNTRAY7mm-13x32
8 x 8mm	1.0mm	260	10 x 26	CO-34AB	QFNTRAY8mm-10x26
9 x 9mm	1.0mm	260	10 x 26	CO-34AB	QFNTRAY9mm-10x26
10 x 10mm	1.0mm	168	8 x 21	CO-34AC	QFNTRAY10mm-8x21
12 x 12mm	1.0mm	168	8 x 21	CO-34AC	QFNTRAY12mm-8x21
12 x 12mm	1.0mm	189	9 x 21	Standard	QFNTRAY12mm-9x21

Component At-A-Glance

QFN - SQUARE

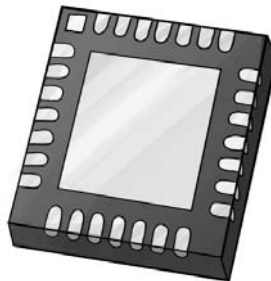

Good to Know

QFN packages are normally thinner than 1.0mm.
 Trays for thicker QFN (1.1mm to 1.5mm) also available.
 QFN trays can safely be used for LGA (Land Grid Array) components.
 For assistance, send the component manufacturer datasheet to TopLine.

INFO

- Note 1: JEDEC Standard Outline 136 x 315mm (322.5mm with end tabs).
- Note 2: Standard tray color: Black conductive or dissipative molding compound ESD safe.
- Note 3: Five to size JEDEC trays may be safely stacked with empty tray on top as a cover.
- Note 4: Secure with 3x ESD Velcro straps or heavy duty black conductive rubber bands (4.5"L x 0.5"W).
- Note 5: Colored tray clips are available in 11 colors for quick visual identification: Sorting, aging and testing.
- Note 6: Tray Temperature rating 140°C or 150°C recommended for component dry baking.
- Note 7: High temperature 180°C available on special order.

QFN Rectangular	Device Thickness	QTY Pockets	MATRIX Row-Column	JEDEC Reference	Tray Part Number
2 x 3mm	1.1mm	490	14 x 35	CO-34AA	QFNTRAY2x3mm-14x35
2 x 5.6mm	1.5mm	364	14 x 26	CO-34AG	QFNTRAY2x5.6mm-14x26
2.8 x 3.6mm	1.1mm	490	14 x 35	CO-34AA	QFNTRAY2.8x3.6mm-14x35
2.8 x 5.6mm	1.5mm	364	14 x 26	Special	QFNTRAY2.8x5.6mm-14x26
3 x 4mm	1.2mm	490	14 x 35	CO-34AA	QFNTRAY3x4mm-14x35
3.75 x 5mm	1.5mm	490	14 x 35	CO-34AA	QFNTRAY3.75x5mm-14x35
4 x 7.5mm	1.3mm	364	14 x 26	CO-34AG	QFNTRAY4x7.5mm-14x26
4 x 10.5mm	1.3mm	294	14 x 21	CO-34AH	QFNTRAY4x10.5mm-14x21
4 x 13mm	0.9mm	238	14 x 17	Special	QFNTRAY4x13mm-14x17
5 x 3.5mm	1.1mm	490	14 x 35	Special	QFNTRAY5x3.5mm-14x35
6 x 4mm	1.2mm	300	12 x 25	Special	QFNTRAY6x4mm-12x25
6 x 8.5mm	1.9mm	364	14 x 26	CO-34AG	QFNTRAY6x8.5mm-14x26
7 x 10.1mm	1.4mm	210	10 x 21	CO-34AJ	QFNTRAY7x10.1mm-10x21
9.1 x 11.9mm	1.8mm	160	8 x 20	Special	QFNTRAY9.1x11.9mm-8x20
10 x 6.5mm	3.2mm	208	8 x 26	Special	QFNTRAY10x6.5mm-8x26
11 x 5.5mm	1.3mm	280	8 x 35	Special	QFNTRAY11x5.5mm-8x35
12 x 6mm	1.3mm	208	8 x 26	Special	QFNTRAY12x6mm-8x26

Contact TopLine for other rectangular sizes available.

Component At-A-Glance

QFN - RECTANGULAR



Good to Know

QFN packages are normally thinner than 1.0mm.
 Trays for thicker QFN (1.1mm to 1.5mm) also available.
 QFN trays can safely be used for LGA (Land Grid Array) components.
 For assistance, send the component manufacturer datasheet to TopLine.

INFO

- Note 1: JEDEC Standard Outline 136 x 315mm (322.5mm with end tabs).
- Note 2: Standard tray color: Black conductive or dissipative molding compound ESD safe.
- Note 3: Five to size JEDEC trays may be safely stacked with empty tray on top as a cover.
- Note 4: Secure with 3x ESD Velcro straps or heavy duty black conductive rubber bands (4.5"L x 0.5"W).
- Note 5: Colored tray clips are available in 11 colors for quick visual identification: Sorting, aging and testing.
- Note 6: Tray Temperature rating 140°C or 150°C recommended for component dry baking.
- Note 7: High temperature 180°C available on special order.

Nbr Pins	Body Size	Pitch	Device Thick	QTY Pocket	MATRIX Row-Column	Device Type	Tray Part Number
8-L	3.0 x 3.0mm	0.65mm	1.0mm	360	12 x 30	MSOP8	MSOP8TRAY-12x30
	3.9 x 4.9mm	1.27mm	1.7mm	180	10 x 18	SO8	SO8TRAY-10x18
	5.3 x 5.3mm	1.27mm	1.95mm	360	12 x 30	SOP8	SOP8TRAY-12x30
10-L	3.0 x 3.0mm	0.5mm	1.0mm	360	12 x 30	MSOP10	MSOP10TRAY-12x30
14-L	3.9 x 8.7mm	1.27mm	1.7mm	160	8 x 20	SO14	SO14TRAY-8x20
16-L	4.4 x 5.0mm	0.65mm	1.2mm	160	8 x 20	TSSOP16	TSSOP16TRAY-8x20
	3.9 x 4.9mm	0.635mm	1.7mm	180	10 x 18	QSOP16	QSOP16TRAY-10x18
	3.9 x 4.9mm	0.635mm	1.7mm	176	8 x 22	QSOP16	QSOP16TRAY-8x22
	7.5 x 10.3mm	1.27mm	2.30mm	240	10 x 24	SOL16	SOL16TRAY-10x24
	7.5 x 10.3mm	1.27mm	2.35mm	160	8 x 20	SOL16	SOL16TRAY-8x20
	7.5 x 10.3mm	1.27mm	2.6mm	176	8 x 22	SOL16	SOL16TRAY-8x22
	7.5 x 10.3mm	1.27mm	2.8mm	84	7 x 12	SOL16	SOL16TRAY-7x12
20-L	4.4 x 6.5mm	0.65mm	1.2mm	490	14 x 35	TSSOP20	TSSOP20TRAY14x35
24-L	4.4 x 7.8mm	0.65mm	0.9mm	264	11 x 24	TSSOP24	TSSOP24TRAY11x24

Continued on next page.

Component At-A-Glance

Gull Wing Packages

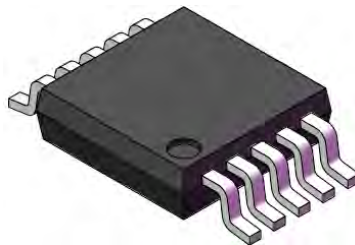

Good to Know:

SOIC Small Outline IC family are known as SO, SOP, MSOP, QSOP, SSOP, TSSOP, VSOP and other.
SOIC components have gull-wing leads that extend from the body of the package.
For assistance, send the component manufacturer datasheet to TopLine.

INFO

- Note 1: JEDEC Standard Outline 136 x 315mm (322.5mm with end tabs).
- Note 2: Standard tray color: Black conductive or dissipative molding compound ESD safe.
- Note 3: Five to size JEDEC trays may be safely stacked with empty tray on top as a cover.
- Note 4: Secure with 3x ESD Velcro straps or heavy duty black conductive rubber bands (4.5"L x 0.5"W).
- Note 5: Colored tray clips are available in 11 colors for quick visual identification: Sorting, aging and testing.
- Note 6: Tray Temperature rating 140°C or 150°C recommended for component dry baking.
- Note 7: High temperature 180°C available on special order.

Nbr Pins	Body Size	Pitch	Device Thick	QTY Pocket	MATRIX Row-Column	Device Type	Tray Part Number
28-L	4.4 x 9.7mm	0.65mm	0.9mm	308	14 x 22	TSSOP28	TSSOP28TRAY-14x22
	5.3 x 10.2mm	0.65mm	1.8mm	242	11 x 22	SSOP28	SSOP28TRAY-11x22
30-L	4.4 x 7.8mm	0.5mm	0.9mm	264	11 x 24	TSSOP30	TSSOP30TRAY-11x24
32-L	11.4 x 20.5mm	1.27mm	2.8mm	45	5 x 9	SOY32	SOY32TRAY-5x9
	11.0 x 21.0mm	1.27mm	2.65mm	104	8 x 13	SOP32	SOP32TRAY-8x13
38-L	4.4 x 9.7mm	0.5mm	0.9mm	308	14 x 22	TSSOP38	TSSOP38-TRAY-14x22
44-L	4.4 x 11.3mm	0.5mm	0.9mm	242	11 x 22	TSSOP44	TSSOP44TRAY-11x22
	13.3 x 28.2mm	1.27mm	2.7mm	40	5 x 8	SOZ44	SOP44TRAY-5x8
48-L	6.1 x 12.5mm	0.5mm	1.0mm	228	12 x 19	TSSOP48	TSSOP48-TRAY-12x19
56-L	4.4 x 11.3mm	0.4mm	0.9mm	242	11 x 22	TSSOP56A	TSSOP56A-TRAY-11x22
	6.1 x 14.0mm	0.5mm	0.9mm	180	10 x 18	TSSOP56B	TSSOP56B-TRAY-10x18

Component At-A-Glance

Gull Wing Packages

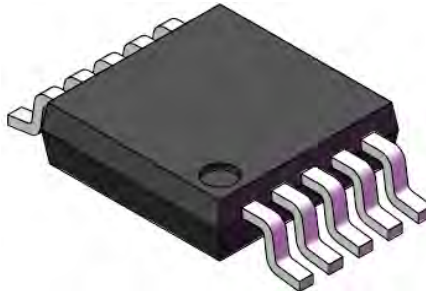

Good to Know:

SOIC Small Outline IC family are known as SO, SOP, MSOP, QSOP, SSOP, TSSOP, VSOP and other.
SOIC components have gull-wing leads that extend from the body of the package.
For assistance, send the component manufacturer datasheet to TopLine.

INFO

- Note 1: JEDEC Standard Outline 136 x 315mm (322.5mm with end tabs).
- Note 2: Standard tray color: Black conductive or dissipative molding compound ESD safe.
- Note 3: Five to size JEDEC trays may be safely stacked with empty tray on top as a cover.
- Note 4: Secure with 3x ESD Velcro straps or heavy duty black conductive rubber bands (4.5"L x 0.5"W).
- Note 5: Colored tray clips are available in 11 colors for quick visual identification: Sorting, aging and testing.
- Note 6: Tray Temperature rating 140°C or 150°C recommended for component dry baking.
- Note 7: High temperature 180°C available on special order.

Nbr Pins	Body Size Including Pins	Pitch	Device Thick	QTY Pocket	MATRIX Row-Column	Device Type	Tray Part Number
28-L	8 x 13.4mm	0.55mm	1.0mm	234	13 x 18	TSOP(I)28S	TTRAY8x13.4-13x18
32-L		0.50mm				TSOP(I)32S	
32-L	8 x 20mm	0.5mm	1.0mm	156	12 x 13	TSOP(I)32	TTRAY8x20-12x13
40-L	10 x 14mm	0.5mm	1.0mm	160	10 x 16	TSOP(I)40S	TTRAY10x14-10x16
40-L	10 x 20mm	0.5mm	1.0mm	120	10 x 12	TSOP(I)40	TTRAY10x20-12x10
48-L	12 x 20mm	0.5mm	1.0mm	96	8 x 12	TSOP(I)48	TTRAY12x20-8x12
56-L	14 x 20mm	0.5mm	1.0mm	91	7 x 13	TSOP(I)56	TTRAY12x20-7x13
56-L	14 x 20mm	0.5mm	1.0mm	96	8 x 12	TSOP(I)56	TTRAY12x20-8x12

Component At-A-Glance

TSOP TYPE 1



Good to Know:

- TSOP TYPE 1 pins are located at the narrow side of the package.
- Dimension includes body and the pins.
- For assistance, send the component manufacturer datasheet to TopLine.

INFO

- Note 1: JEDEC Standard Outline 136 x 315mm (322.5mm with end tabs).
- Note 2: Standard tray color: Black conductive or dissipative molding compound ESD safe.
- Note 3: Five to size JEDEC trays may be safely stacked with empty tray on top as a cover.
- Note 4: Secure with 3x ESD Velcro straps or heavy duty black conductive rubber bands (4.5"L x 0.5"W).
- Note 5: Colored tray clips are available in 11 colors for quick visual identification: Sorting, aging and testing.
- Note 6: Tray Temperature rating 140°C or 150°C recommended for component dry baking.
- Note 7: High temperature 180°C available on special order.

Nbr Pins	Body Size Excluding Pins	Pitch	Device Thick	QTY Pocket	MATRIX Row-Column	Device Type	Tray Part Number
44L	10.16 x 18.4mm (0.40"x 0.725")	0.8mm	1.0mm	135	9 x 15	TSOP(II)44	T2RAY10x18.4-9x15
32-L 50-L	10.16 x 21mm (0.40"x 0.825")	1.27mm 0.8mm	1.0mm	117	9 x 13	TSOP(II)32 TSOP(II)50	T2RAY10x21-9x13
54-L 66-L 86-L	10.16 x 22.22mm (0.40"x 0.875")	0.8mm 0.65mm 0.5mm	1.0mm	108	9 x 12	TSOP(II)54 TSOP(II)66 TSOP(II)86	T2RAY10x22-9x12

Component At-A-Glance

TSOP TYPE 2



Good to Know:

TSOP TYPE 2 pins are located at the wide side of the package.
 Dimensions are body only (Excluding length of pins.)
 For assistance, send the component manufacturer datasheet to TopLine.

INFO

- Note 1: JEDEC Standard Outline 136 x 315mm (322.5mm with end tabs).
- Note 2: Standard tray color: Black conductive or dissipative molding compound ESD safe.
- Note 3: Five to size JEDEC trays may be safely stacked with empty tray on top as a cover.
- Note 4: Secure with 3x ESD Velcro straps or heavy duty black conductive rubber bands (4.5"L x 0.5"W).
- Note 5: Colored tray clips are available in 11 colors for quick visual identification: Sorting, aging and testing.
- Note 6: Tray Temperature rating 140°C or 150°C recommended for component dry baking.
- Note 7: High temperature 180°C available on special order.

Nbr Pins	Body Size Excluding Pins	Device Package	Device Thick	QTY Pocket	MATRIX Row-Column	Device Type	Tray Part Number
28-L	11.5 x 11.5mm	Plastic	4.3mm	55	5 x 11	PLCC28	PLCC28TRAY-5x11
28-L	11.5 x 11.5mm	Plastic	4.1mm	84	7 x 12	PLCC28	PLCC28TRAY-7x12
32-L	11.5 x 14.0mm	Plastic	3.1mm	128	8 x 16	PLCC32	PLCC32TRAY-8x16
44-L	16.6 x 16.6mm	Plastic	4.3mm	40	4 x 10	PLCC44	PLCC44TRAY-4x10
44-L	16.6 x 16.6mm	Plastic	3.6mm	84	6 x 14	PLCC44	PLCC44TRAY-6x14
48-L	14.2 x 14.2mm	Plastic	4.3mm	40	4 x 10	PLCC	PLCC48TRAY-4x10
48-L	14.2 x 14.2mm	Ceramic	2.8mm	40	4 x 10	CLCC48	CLCC48TRAY-4x10
52-L	19.1x 19.1mm	Plastic	4.3mm	36	4 x 9	PLCC52	PLCC52TRAY-4x9
68-L	24.2 x 24.2mm	Plastic	4.3mm	21	3 x 7	PLCC68	PLCC68TRAY-3x7
68-L	24.2 x 24.2mm	Ceramic	6.0mm	10	2 x 5	CLCC68	CLCC68TRAY-2x5
84-L	29.3 x 29.3mm	Plastic	4.3mm	21	3 x 7	PLCC84	PLCC84TRAY-3x7

Component At-A-Glance

**PLCC Plastic
J-Lead**



**CLCC Ceramic
J-Lead**

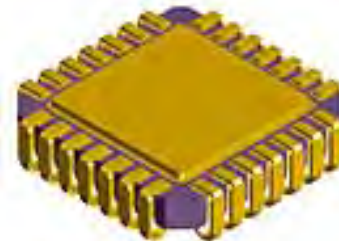

Good to Know:

PLCC (Plastic) with J-Leads.
CLCC - JLCC (Ceramic) with J-Leads
For assistance, send the component manufacturer datasheet to TopLine.

INFO

- Note 1: JEDEC Standard Outline 136 x 315mm (322.5mm with end tabs).
- Note 2: Standard tray color: Black conductive or dissipative molding compound ESD safe.
- Note 3: Five to size JEDEC trays may be safely stacked with empty tray on top as a cover.
- Note 4: Secure with 3x ESD Velcro straps or heavy duty black conductive rubber bands (4.5"L x 0.5"W).
- Note 5: Colored tray clips are available in 11 colors for quick visual identification: Sorting, aging and testing.
- Note 6: Tray Temperature rating 140°C or 150°C recommended for component dry baking.
- Note 7: High temperature 180°C available on special order.

Nbr Pins	Body Size Excluding Pins	Device Package	Device Thick	QTY Pocket	MATRIX Row-Column	Device Type	Tray Part Number
20-L	8.9 x 8.9mm (0.35" x 0.35")	Ceramic	2.4mm	Call	Call	LCC20	LGATRAY9mm
28-L	11.4 x 11.4mm (0.45" x 0.45")	Ceramic	2.4mm	Call	Call	LCC28	LGATRAY11.5mm
32-L	11.4 x 14mm (0.45" x 0.55")	Ceramic	2.4mm	Call	Call	LCC32	LGATRAY12x14mm
40-L	12.2 x 12.2mm (0.48" x 0.48")	Ceramic	2.4mm	Call	Call	LCC40	LGATRAY12.5mm
44-L	16.5 x 16.5mm (0.65" x 0.65")	Ceramic	2.4mm	Call	Call	LCC44	LGATRAY16.5mm
48-L	14.2 x 14.2mm (0.56" x 0.56")	Ceramic	2.4mm	Call	Call	LCC48	LGATRAY14.5mm
52-L	19.1 x 19.1mm (0.75" x 0.75")	Ceramic	2.4mm	Call	Call	LCC52	LGATRAY19.5mm
64-L	18.3 x 18.3mm (0.72" x 0.72")	Ceramic	2.4mm	Call	Call	LCC64	LGATRAY18.5mm
68-L	24.1 x 24.1mm (0.95" x 0.95")	Ceramic	2.4mm	Call	Call	LCC68	LGATRAY24.5mm
84-L	29.2 x 29.2mm (1.15" x 1.15")	Ceramic	2.4mm	Call	Call	LCC84	LGATRAY29.5mm

Component At-A-Glance

Top View

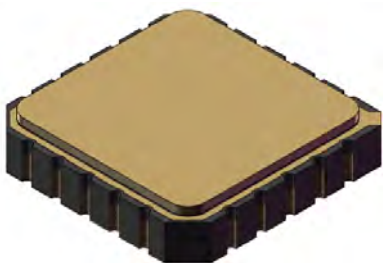

Bottom View

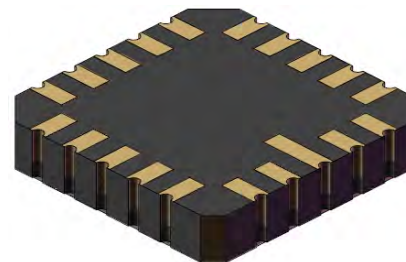

Good to Know:

LCC (ceramic package) with leadless castellations.
For assistance, send the component manufacturer datasheet to TopLine.

INFO

- Note 1: JEDEC Standard Outline 136 x 315mm (322.5mm with end tabs).
- Note 2: Standard tray color: Black conductive or dissipative molding compound ESD safe.
- Note 3: Five to size JEDEC trays may be safely stacked with empty tray on top as a cover.
- Note 4: Secure with 3x ESD Velcro straps or heavy duty black conductive rubber bands (4.5"L x 0.5"W).
- Note 5: Colored tray clips are available in 11 colors for quick visual identification: Sorting, aging and testing.
- Note 6: Tray Temperature rating 140°C or 150°C recommended for component dry baking.
- Note 7: High temperature 180°C available on special order.

BGA Body Size	QTY Pockets	MATRIX Row-Column	JEDEC Reference	Tray Part Number
5 x 5mm	490	14 x 35	-	BGATRAY5mm-14x35
	576	16 x 36	CS-029-AAA	BGATRAY5mm-16x36
	624	16 x 39	-	BGATRAY5mm-16x39
	640	16 x 40	-	BGATRAY5mm-16x40
6 x 6mm	360	12 x 30	-	BGATRAY6mm-12x30
	377	13 x 29	-	BGATRAY6mm-13x29
	429	13 x 33	-	BGATRAY6mm-13x33
	608	16 x 38	-	BGATRAY6mm-16x38
7 x 7mm	260	10 x 26	-	BGATRAY7mm-10x26
	416	13 x 32	CS-029AA	BGATRAY7mm-13x32
	476	14 x 34	-	BGATRAY7mm-14x34
8 x 8mm	260	10 X 26	-	BGATRAY8mm-10x26
	348	12 X 29	CS-029AAB	BGATRAY8mm-12x29
	360	12 X 30	-	BGATRAY8mm-12x30
9 x 9mm	250	10 X 25	-	BGATRAY9mm-10x25
	260	10 X 26	CS-029AB	BGATRAY9mm-10x26

Component At-A-Glance

BGA TOP VIEW

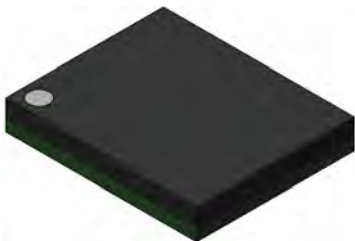

BGA BALL VIEW



Good to Know:

BGA – Ball Grid Array.
Also known as PBGA (Plastic Ball Grid Array).
All BGA trays can safely be used for LGA (Land Grid Arrays)
For assistance, send the component manufacturer datasheet to TopLine.

INFO

- Note 1: JEDEC Standard Outline 136 x 315mm (322.5mm with end tabs).
- Note 2: Standard tray color: Black conductive or dissipative molding compound ESD safe.
- Note 3: Five to size JEDEC trays may be safely stacked with empty tray on top as a cover.
- Note 4: Secure with 3x ESD Velcro straps or heavy duty black conductive rubber bands (4.5" L x 0.5" W).
- Note 5: Colored tray clips are available in 11 colors for quick visual identification: Sorting, aging and testing.
- Note 6: Tray Temperature rating 140°C or 150°C recommended for component dry baking.
- Note 7: High temperature 180°C available on special order.

BGA Body Size	QTY Pockets	MATRIX Row-Column	JEDEC Reference	Tray Part Number
10 x 10mm	168	8 x 21	-	BGATRAY10mm-8x21
	184	8 x 23	-	BGATRAY10mm-8x23
	240	10 x 24	CS-029-AY	BGATRAY10mm-10x24
	250	10 x 25	-	BGATRAY10mm-10x25
11 x 11mm	176	8 x 22	CS-029-AC	BGATRAY11mm-8x22
12 x 12mm	133	7 x 19	-	BGATRAY12mm-7x19
	160	8 x 20	-	BGATRAY12mm-8x20
	168	8 x 21	-	BGATRAY12mm-8x21
	189	9 x 21	CS-029AZ	BGATRAY12mm-9x21
	198	9 x 22	-	BGATRAY12mm-9x22
13 x 13mm	160	8 X 20	CS-029-AD	BGATRAY13mm-8x20
14 x 14mm	119	7 X 17	-	BGATRAY14mm-7x17
	152	8 X 19	CS-029-AAC	BGATRAY14mm-8x19
15 x 15mm	119	7 X 17	-	BGATRAY15mm-7x17
	126	7 X 18	CS-029-AE	BGATRAY15mm-7x18
16 x 16mm	84	6 X 14	-	BGATRAY16mm-6x14
	90	6 X 15	-	BGATRAY16mm-6x15
	119	7 X 17	-	BGATRAY16mm-7x17

Component At-A-Glance

BGA TOP VIEW

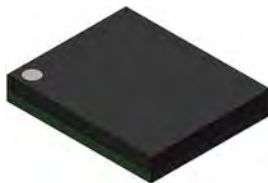

BGA BALL VIEW



Good to Know:

BGA – Ball Grid Array.

Also known as PBGA (Plastic Ball Grid Array).

All BGA trays can safely be used for LGA (Land Grid Arrays)

For assistance, send the component manufacturer datasheet to TopLine.

INFO

Note 1: JEDEC Standard Outline 136 x 315mm (322.5mm with end tabs).

Note 2: Standard tray color: Black conductive or dissipative molding compound ESD safe.

Note 3: Five to size JEDEC trays may be safely stacked with empty tray on top as a cover.

Note 4: Secure with 3x ESD Velcro straps or heavy duty black conductive rubber bands (4.5" L x 0.5" W).

Note 5: Colored tray clips are available in 11 colors for quick visual identification: Sorting, aging and testing.

Note 6: Tray Temperature rating 140°C or 150°C recommended for component dry baking.

Note 7: High temperature 180°C available on special order.

BGA Body Size	QTY Pockets	MATRIX Row-Column	JEDEC Reference	Tray Part Number
17 x 17mm	90	6 x 15	CS-029-AF	BGATRAY17mm-6x15
18 x 18mm	65	5 x 13	-	BGATRAY18mm-5x13
	84	6 x 14	CS-029-AG	BGATRAY18mm-6x14
	90	6 x 15	-	BGATRAY18mm-6x15
19 x 19mm	84	6 x 14	CS-029-AG	BGATRAY19mm-6x14
20 x 20mm	60	5 x 12	-	BGATRAY20mm-5x12
21 x 21mm	60	5 x 12	CS-029-AH	BGATRAY21mm-5x12
23 x 23mm	60	5 x 12	CS-029-AJ	BGATRAY23mm-5x12
24 x 24mm	44	4 x 11	-	BGATRAY24mm-4x11
25 x 25mm	44	4 x 11	CS-029-AK	BGATRAY25mm-4x11
27 x 27mm	40	4 x 10	CS-029-AL	BGATRAY27mm-4x10
29 x 29mm	36	4 x 9	CS-029-AM	BGATRAY29mm-4x9
31 x 31mm	27	3 x 9	CS-029-AN	BGATRAY31mm-3x9
32.5 x 32.5mm	24	3 x 9	CS-028-AE	BGATRAY32.5mm-3x8
33 x 33mm	24	3 x 8	CS-029-AP	BGATRAY33mm-3x8
35 x 35mm	24	3 x 8	CS-029-AR	BGATRAY35mm-3x8
37.5 x 37.5mm	21	3 x 7	CS-029-AS	BGATRAY37.5mm-3x7

Component At-A-Glance

BGA TOP VIEW



BGA BALL VIEW



Good to Know:

BGA – Ball Grid Array.

Also known as PBGA (Plastic Ball Grid Array).

All BGA trays can safely be used for LGA (Land Grid Arrays)

For assistance, send the component manufacturer datasheet to TopLine.

INFO

Note 1: JEDEC Standard Outline 136 x 315mm (322.5mm with end tabs).

Note 2: Standard tray color: Black conductive or dissipative molding compound ESD safe.

Note 3: Five to size JEDEC trays may be safely stacked with empty tray on top as a cover.

Note 4: Secure with 3x ESD Velcro straps or heavy duty black conductive rubber bands (4.5"L x 0.5"W).

Note 5: Colored tray clips are available in 11 colors for quick visual identification: Sorting, aging and testing.

Note 6: Tray Temperature rating 140°C or 150°C recommended for component dry baking.

Note 7: High temperature 180°C available on special order.

BGA Body Size	QTY Pockets	MATRIX Row-Column	JEDEC Reference	Tray Part Number
40 x 40mm	21	3 x 7	CS-029-AT	BGATRAY40mm-3x7
42.5 x 42.5mm	12	2 x 6	CS-029-AU	BGATRAY42.5mm-2x6
45 x 45mm	12	2 x 6	CS-029-AV	BGATRAY45mm-2x6
47.5 x 47.5mm	12	2 x 6	CS-029-AW	BGATRAY47.5mm-2x6
50 x 50mm	10	2 x 5	CS-029-AX	BGATRAY50mm-2x5
51 x 51mm	10	2 x 5	-	BGATRAY51mm-2x5
52.5 x 52.5mm	10	2 x 5	-	BGATRAY52.5mm-2x5
55 x 55mm	10	2 x 5	-	BGATRAY55mm-2x5
58 x 58mm	10	2 x 5	-	BGATRAY58mm-2x5
61 x 61mm	8	2 x 4	-	BGATRAY61mm-2x4

Component At-A-Glance

BGA TOP VIEW



BGA BALL VIEW



Good to Know:

BGA – Ball Grid Array.

Also known as PBGA (Plastic Ball Grid Array).

All BGA trays can safely be used for LGA (Land Grid Arrays)

For assistance, send the component manufacturer datasheet to TopLine.

INFO

Note 1: JEDEC Standard Outline 136 x 315mm (322.5mm with end tabs).

Note 2: Standard tray color: Black conductive or dissipative molding compound ESD safe.

Note 3: Five to size JEDEC trays may be safely stacked with empty tray on top as a cover.

Note 4: Secure with 3x ESD Velcro straps or heavy duty black conductive rubber bands (4.5”L x 0.5”W).

Note 5: Colored tray clips are available in 11 colors for quick visual identification: Sorting, aging and testing.

Note 6: Tray Temperature rating 140°C or 150°C recommended for component dry baking.

Note 7: High temperature 180°C available on special order.

BGA Body Size	QTY Pockets	MATRIX Row-Column	JEDEC Reference	Tray Part Number
5.0 x 6.0mm	490	14 x 35		BGATRAY5x6mm-14x35
5.0 x 7.0mm	338	13 x 26		BGATRAY5x7mm-13x26
5.0 x 7.0mm	364	14 x 26		BGATRAY5x7mm-14x26
6.0 x 7.0mm	348	12 x 29		BGATRAY6x7mm-12x29
6.0 x 8.0mm	364	14 x 26		BGATRAY6x8mm-14x26
6.0 x 8.0mm	480	16 x 30		BGATRAY6x8mm-16x30
7.0 x 9.0mm	260	10 x 26		BGATRAY7x9mm-10x26
8.0 x 9.0mm	336	12 x 28		BGATRAY8x9mm-12x28
8.0 x 10mm	208	8 x 26		BGATRAY8x10mm-8x26
8.0 x 10mm	290	10 x 29		BGATRAY8x10mm-10x29
8.0 x 10.5mm	136	8 x 17		BGATRAY8x10.5mm-8x17
8.0 x 11mm	210	10 x 21		BGATRAY8x11mm-10x21
8.0 x 11mm	232	8 x 29		BGATRAY8x11mm-8x29
8.0 x 12.5mm	228	12 x 19		BGATRAY8x12.5mm-12x19
8.0 x 13mm	228	12 x 19		BGATRAY8x13mm-12x19
8.0 x 13mm	240	12 x 20		BGATRAY8x13mm-12x20
8.0 x 14mm	228	12 x 19		BGATRAY8x14mm-12x19

Continued Next Page

Component At-A-Glance

BGA TOP VIEW

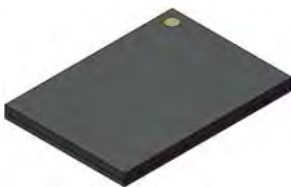

BGA BALL VIEW

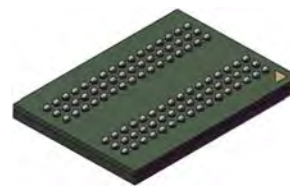

Good to Know:

BGA – Ball Grid Array.

Also known as PBGA (Plastic Ball Grid Array).

All BGA trays can safely be used for LGA (Land Grid Arrays)

For assistance, send the component manufacturer datasheet to TopLine.

INFO

Note 1: JEDEC Standard Outline 136 x 315mm (322.5mm with end tabs).

Note 2: Standard tray color: Black conductive or dissipative molding compound ESD safe.

Note 3: Five to size JEDEC trays may be safely stacked with empty tray on top as a cover.

Note 4: Secure with 3x ESD Velcro straps or heavy duty black conductive rubber bands (4.5"L x 0.5"W).

Note 5: Colored tray clips are available in 11 colors for quick visual identification: Sorting, aging and testing.

Note 6: Tray Temperature rating 140°C or 150°C recommended for component dry baking.

Note 7: High temperature 180°C available on special order.

BGA Body Size	QTY Pockets	MATRIX Row-Column	JEDEC Reference	Tray Part Number
9.0 x 8mm	240	10 x 24		BGATRAY9x8mm-10x24
9.0 x 11mm	210	10 x 21		BGATRAY9x11mm-10x21
9.0 x 12mm	200	10 x 20		BGATRAY9x12mm-10x20
9.0 x 12mm	210	10 x 21		BGATRAY9x12mm-10x21
9.0 x 13mm	220	11 x 20		BGATRAY9x13mm-11x20
9.0 x 13.3mm	112	8 x 14		BGATRAY9x13.3mm-8x14
10 x 11mm	128	8 x 16		BGATRAY10x11mm-8x16
10 x 12mm	192	8 x 24		BGATRAY10x12mm-8x24
10 x 12mm	210	10 x 21		BGATRAY10x12mm-10x21
10 x 12.5mm	136	8 x 17		BGATRAY10x12.5mm-8x17
10 x 13mm	144	10 x 13		BGATRAY10x13mm-10x13
10 x 14mm	136	8 x 17		BGATRAY10x14mm-8x17
10 x 17mm	112	8 x 14		BGATRAY10x17mm-8x14
11 x 13mm	160	8 x 20		BGATRAY11x13mm-8x20
11 x 13mm	180	9 x 20		BGATRAY11x13mm-9x20
11 x 18mm	112	8 x 14		BGATRAY11x18mm-8x14
11.5 x 13mm	152	8 x 19		BGATRAY11.5x13mm-8x19

Continued Next Page

Component At-A-Glance

BGA TOP VIEW



BGA BALL VIEW



Good to Know:

BGA – Ball Grid Array.

Also known as PBGA (Plastic Ball Grid Array).

All BGA trays can safely be used for LGA (Land Grid Arrays)

For assistance, send the component manufacturer datasheet to TopLine.

INFO

Note 1: JEDEC Standard Outline 136 x 315mm (322.5mm with end tabs).

Note 2: Standard tray color: Black conductive or dissipative molding compound ESD safe.

Note 3: Five to size JEDEC trays may be safely stacked with empty tray on top as a cover.

Note 4: Secure with 3x ESD Velcro straps or heavy duty black conductive rubber bands (4.5”L x 0.5”W).

Note 5: Colored tray clips are available in 11 colors for quick visual identification: Sorting, aging and testing.

Note 6: Tray Temperature rating 140°C or 150°C recommended for component dry baking.

Note 7: High temperature 180°C available on special order.

BGA Body Size	QTY Pockets	MATRIX Row-Column	JEDEC Reference	Tray Part Number
12 x 12.5mm	180	9 x 20		BGATRAY12x12.5mm-9x20
12 x 13mm	152	8 x 19		BGATRAY12x13mm-8x19
12 x 14mm	119	7 x 17		BGATRAY12x14mm-7x17
12 x 18mm	112	8 x 14		BGATRAY12x18mm-8x14
13 x 15mm	136	8 x 17		BGATRAY13x15mm-8x17
13 x 15mm	160	8 x 20		BGATRAY13x15mm-8x20
14 x 18mm	98	7 x 14		BGATRAY14x18mm-7x14
14 x 19mm	84	6 x 14		BGATRAY14x19mm-6x14
14 x 22mm	66	6 x 11		BGATRAY14x22mm-6x11
14 x 22mm	84	7 x 12		BGATRAY14x22mm-7x12
15 x 13mm	119	7 x 17		BGATRAY15x13mm-7x17
15 x 17mm	72	6 x 12		BGATRAY15x17mm-6x12
18 x 16mm	75	5 x 15		BGATRAY18x16mm-5x15
21 x 25mm	55	5 x 11		BGATRAY21x25mm-5x11
25 x 32.5mm	32	4 x 8		BGATRAY25x32.5mm-4x8
29 x 22mm	36	3 x 12		BGATRAY29x22mm-3x12

Component At-A-Glance

BGA TOP VIEW



BGA BALL VIEW



Good to Know:

BGA – Ball Grid Array.

Also known as PBGA (Plastic Ball Grid Array).

All BGA trays can safely be used for LGA (Land Grid Arrays)

For assistance, send the component manufacturer datasheet to TopLine.

INFO

Note 1: JEDEC Standard Outline 136 x 315mm (322.5mm with end tabs).

Note 2: Standard tray color: Black conductive or dissipative molding compound ESD safe.

Note 3: Five to size JEDEC trays may be safely stacked with empty tray on top as a cover.

Note 4: Secure with 3x ESD Velcro straps or heavy duty black conductive rubber bands (4.5”L x 0.5”W).

Note 5: Colored tray clips are available in 11 colors for quick visual identification: Sorting, aging and testing.

Note 6: Tray Temperature rating 140°C or 150°C recommended for component dry baking.

Note 7: High temperature 180°C available on special order.

Universal Tray Cover & Bottom

ESD Safe - Reusable

Fits all JEDEC Trays

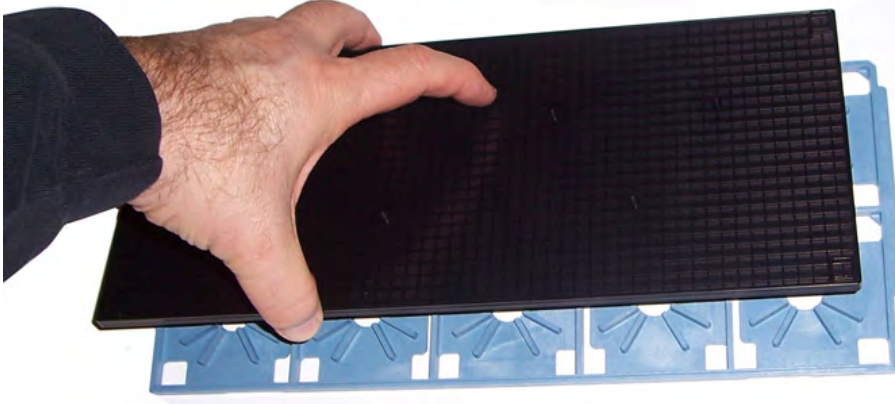

Fits all JEDEC matrix IC trays

Specs:

ESD Safe • Reusable
Bakeable 150°C
Standard Color: Black (MPPE)
Resistivity $10^5 \sim 10^9 \Omega$

Applications:

Keeps components dust free.
Faraday shield protection.

Universal plate.

Covers top and bottom.
One part number - two

Part Nbr: COVERTRAY BLACK
[Order code 110000](#)

Easy use.

The same plate snaps onto the top and/or bottom of all JEDEC matrix trays
Forms a faraday cage shield around components.



Example: Blue JEDEC tray with COVERTRAY BLACK on Top and Bottom



ESD Tray Straps VGRIP-01 Fits all JEDEC Trays

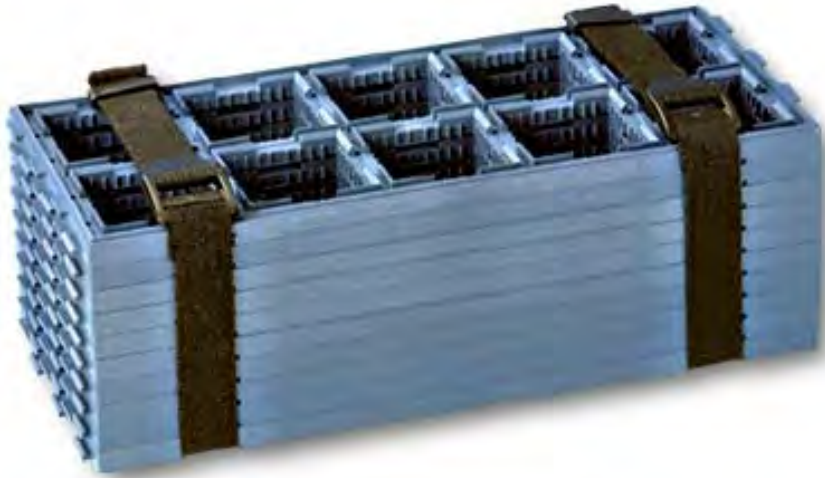

Fits all JEDEC and EIAJ IC trays.
Out performs all existing tray straps on the market.
Also can be used for bundling tubes.

Specs:

Permanently ESD Safe
Reusable and Recyclable
Quick Release Buckle
Standard Color: Black
Resistivity $10^5 \sim 10^6 \Omega$

Application:

580mm length secures 10 to 12 trays, depending on tray thickness.

Permanent ESD Safe:

Strong and durable black strap is made with permanent ESD features. With D-ring. Velcro is sewn on the belt.

Part Nbr: VGRIP-01

885000 Bag 1
885100 Bag 100

How it is tested:

The hook & loop on the VGRIP is plastic; therefore, it has a tendency to load up charges. The strap is conductive and discharges static safely, when grounded in an EPA. The VGRIP is made with permanent conductive fibers, which will not lose its ESD properties over time. The VGRIP is not dipped with topical anti-static agents. Dipped, anti-static agents are notorious for slowly losing its ESD properties over time.

The conductive strap of the VGRIP will quickly discharge the buildup of static, when grounded. Operators and work-benches must be grounded while touching the VGRIP and IC trays to discharge the buildup of static charge on the Hook and Loop part.

Refer to ESD standard STD IEC 61340-5-1

ESD Properties of VGRIP Strap

- Resistivity: $10^5 \sim 10^6 \Omega$
- Static Decay Time: 1000V to lower than 100V in less than 1 sec
- Static Generation: Well below 100V/in



VGRIP tray strap under test using a Conductivity meter. The green reading on meter is $> 10^3$ Conductive $< 10^6$ Ohms



Contact: info@TopLine.tv
Tel 1-800-776-9888

Colored IC Tray Clips Fits most JEDEC Trays For visual Identification Sorting, aging, Testing

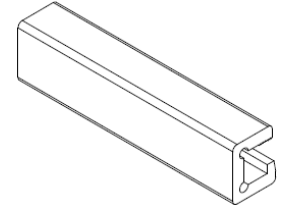

Specs:

Anti static - S.R Ohm/SQ. 1×10^{12}

Bakeable 125°C

25mm (1") Long

Fits most JEDEC matrix IC trays

How to use:

Snap on the clip at the end of JEDEC tray. Removable. Reuseable

Applications:

Quick visual identification for sorting, aging, testing.

Choose from 11 Standard Colors

126001	126002	126003	126005	126006	126007	126009	126012	126013	126015	126016
White	Green	Blue	Orange	Purple	Gold	Red	Yellow	Black	Silver	Brown

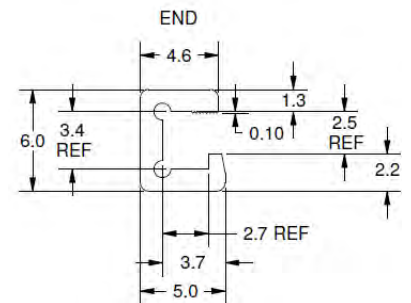
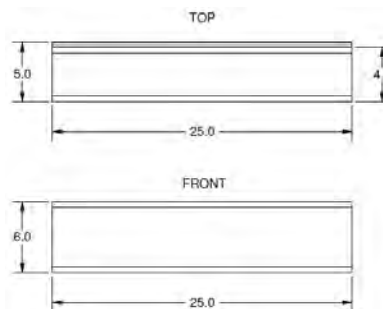

Pick and Place Dimensions:

Start at Chamfer Corner: M (+X) and M1(-Y)

M2, M3 Step Dimensions

N1 Columns, N2 Rows, N3 Cells

Web Page

https://www.topline.tv/tray_coordinates.htm

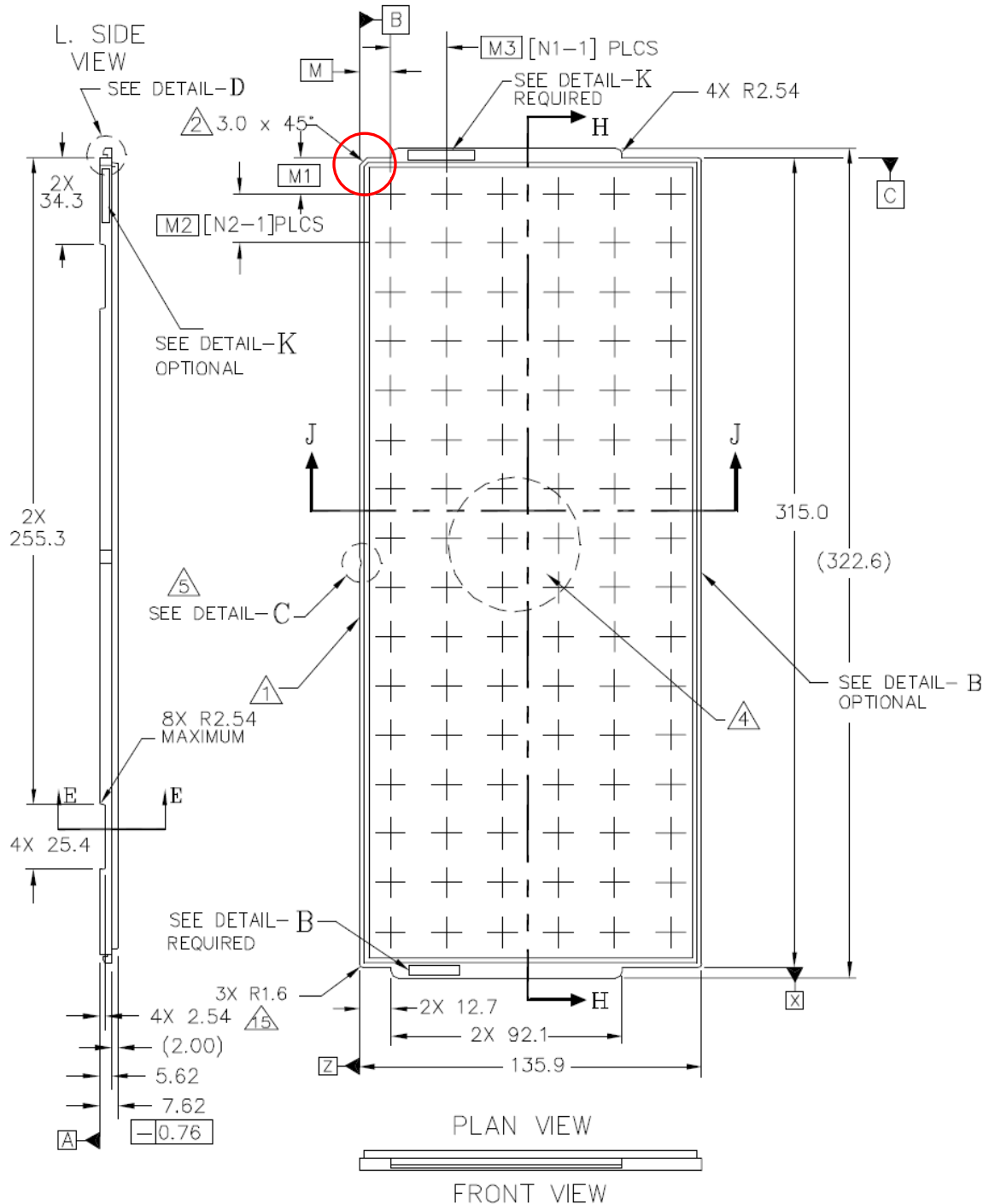



Custom Tray Questionnaire

Date: _____

Contact: _____

Title: _____

Company: _____

Tel: _____

Email: _____

Project /Component: _____
Reference

A. Usage forecast:

1. First time: Quantity of Trays _____ or Number of components _____

2. Future: Quantity of Trays _____ or Number of Components _____

B. Description of the Component:

3. Attach an outline drawing or a sketch of your component (Required)

Notes about components: _____

C. Maximum baking temperature of components in tray: (Check one)

4. No Baking 60°C 125°C 140°C 150°C 180°C (Special)

D. Purpose (application) of tray: (Check all that apply)

5. In house storage Transport Pick & Place Other _____

E. Type of tray: (Check one)

6. JEDEC Outline 2-Inch Waffle Pack 4-inch Waffle Pack Other _____

F. Comments or special needs (Materials, color, stacking, ESD requirements, etc)

Please send the completed questionnaire to TopLine
info@TopLine.tv

Pocket Square Size	QTY Pockets	MATRIX Row-Column	Pocket Depth	Tray Part Number
0.64 mm SQ	484	22 x 22	0.76mm	WP2-0.64x0.64x.76B
1.0 mm SQ	100	10 x 10	0.61mm	WP2-1.0x1.0x.61B
1.4 mm SQ	400	20 x 20	0.61mm	WP2-1.4x1.4x.61B
1.5 mm SQ	400	20 x 20	0.61mm	WP2-1.5x1.5x.61B
2.0 mm SQ	169	13 x 13	0.61mm	WP2-2.0x2.0x.61B
3.3 mm SQ	100	10 x 10	0.61mm	WP2-3.3x3.3x.61B
3.6 mm SQ	100	10 x 10	1.5mm	WP2-3.6x3.6x1.5B
4.3 mm SQ	64	8 x 8	1.07mm	WP2-4.3x4.3x1.07B
5.4 mm SQ	36	6 x 6	0.81mm	WP2-5.4x5.4x.81B
6.5 mm SQ	25	6 x 6	0.81mm	WP2-6.5x6.5x.81B
7.6 mm SQ	25	5 x 5	0.81mm	WP2-7.6x7.6x.81B
8.4 mm SQ	16	4 x 4	0.61mm	WP2-8.4x8.4x.61B
9.5 mm SQ	16	4 x 4	1.0mm	WP2-9.5x9.5x1.0B
9.8 mm SQ	16	4 x 4	1.4mm	WP2-9.8x9.8x1.4B
10.0 mm SQ	16	4 x 4	1.1mm	WP2-10.1x10.1x1.1B
13.4 mm SQ	9	3 x 3	1.1mm	WP2-13.4x13.4x1.1B
14.0 mm SQ	9	3 x 3	1.0mm	WP2-14x14x1.0B
15.9 mm SQ	4	2 x 2	1.07mm	WP2-15.9x15.9x1.07B
20.6 mm SQ	4	2 x 2	1.0mm	WP2-20.6x20.6x1.0B

Example pocket sizes listed above. Many other sizes available. Contact TopLine.

At-A-Glance

TRAY



Cover



CLIP



Contact TopLine for tray pocket size that best fits your chip. Many sizes and pocket depth available. See accessory page for wide assortment of covers, clips and film and Tyvek® inserts.

INFO

- Note 1: WP2 outline 2.0 x 2.0 inch (50.8 x 50.8mm).
- Note 2: Standard tray color is Black. Surface Resistivity $10^3 \sim 10^6$ Ohms/Square
- Note 3: Normally one cover is clipped to one tray. Special clips available to stack five or ten trays.
- Note 4: Dissipative polyethylene inserts or anti-static Tyvek® inserts can be placed between the die and cover.
- Note 5: Standard temperature rating is 70°C.

Pocket Rectangular	QTY Pockets	MATRIX Row-Column	Pocket Depth	Tray Part Number
0.91 x 1.68 mm	96	8 x 12	0.80mm	WP2-1.68x.91x.80B
1.17 x 1.5 mm	400	20 x 20	0.41mm	WP2-1.5x1.17x.41B
1.44 x 2.26 mm	204	12 x 17	1.40mm	WP2-2.26x1.45x1.4B
1.5 x 2.3 mm	180	12 x 15	0.61mm	WP2-2.3x1.5x.61B
1.8 x 3.4 mm	100	10 x 10	0.51mm	WP2-3.4x1.8x51B
1.9 x 3.7 mm	77	7 x 11	1.50mm	WP2-3.7x1.9x1.5B
1.9 x 5.6 mm	70	6 x 14	1.50mm	WP2-5.6x1.9x1.5B
2.5 x 3.2 mm	110	10 x 11	1.27mm	WP2-2.5x3.2x1.27B
2.9 x 5.8 mm	60	6 x 10	1.70mm	WP2-5.8x2.9x1.7B
3.0 x 4.7 mm	96	8 x 12	0.81mm	WP2-3.0x4.7x.81B
3.3 x 5.8mm	70	7 x 10	1.07mm	WP2-5.8x3.3x1.07B
3.8 x 6.3mm	35	5 x 7	0.61mm	WP2-3.8x6.3x0.61B
4.0 x 8.5 mm	28	4 x 7	0.64mm	WP2-4.0x8.5x.64B
4.1 x 5.2mm	48	6 x 8	0.66mm	WP2-5.2x4.1x.66B
5.0 x 6.7 mm	30	5 x 6	1.8mm	WP2-5.0x6.7x1.8B
5.8 x 8.7 mm	24	3 x 8	1.27mm	WP2-5.8x8.7x1.27B
6.5 x 7.3 mm	25	5 x 5	1.90mm	WP2-6.5x7.3x1.9B
10.6 x 16 mm	6	2 x 3	1.27mm	WP2-10.6x16x1.27B
18 x 21 mm	4	2 x 2	0.64mm	WP2-18x21x.64B

Example pocket sizes listed above. Many other sizes available. Contact TopLine.

At-A-Glance

TRAY



Cover



CLIP



Contact TopLine for tray pocket size that best fits your chip. Many sizes and pocket depth available. See accessory page for wide assortment of covers, clips and film and Tyvek® inserts.

INFO

- Note 1: WP2 outline 2.0 x 2.0 inch (50.8 x 50.8mm).
- Note 2: Standard tray color is Black. Surface Resistivity $10^3 \sim 10^6$ Ohms/Square
- Note 3: Normally one cover is clipped to one tray. Special clips available to stack five or ten trays.
- Note 4: Dissipative polyethylene inserts or anti-static Tyvek® inserts can be placed between the die and cover.
- Note 5: Standard temperature rating is 70°C.

Description	Height Adder To Depth of Tray Pocket	Side View	Color	Tray Part Number
Standard Cover	Seals Flush Tight		Black	WP2-COVER
			Amber	WP2-COVER-A
Special Extension Cover For Tall Components	0.152mm 0.006-inch		Black	WP2-0.15mm-COVER
	0.152mm 0.010-inch		Black	WP2-0.25mm-COVER
	0.43mm 0.017-inch		Black	WP2-0.43mm-COVER
	1.0mm 0.043-inch		Black	WP2-1.0mm-COVER
	1.9 mm 0.074-inch		Black	WP2-1.9mm-COVER

At-A-Glance Cover



Contact TopLine for cover that best fits your chip.
 See accessory page for wide assortment of clips, labels, film and Tyvek® inserts.

INFO

- Note 1: WP2 outline 2.0 x 2.0 inch (50.8 x 50.8mm).
- Note 2: Standard cover color is Black. Surface Resistivity $10^3 - 10^6$ Ohms/Square
- Note 3: Standard temperature rating is 70°C.

Description	Nbr Trays	Quick View	Color	Tray Part Number
1-piece Clip	STANDARD Holds 1-tray And 1-cover Order 1x Clip		Black	WP2-CLIP1-B
			Natural	WP2-CLIP1-N
2-piece Clips	STANDARD Holds 1-tray And 1-cover Order 2x Clips		Black	WP2-CLIP2-B
			Natural	WP2-CLIP2-N
	SPECIAL Holds 5-trays And 1-cover Order 2x Clips		Black	WP2-CLIP5-B
			Black	WP2-CLIP10-B

At-A-Glance

1-Piece Clip



2-Piece Clip





Stacking 2-Piece Clip



Contact TopLine for tray pocket size that best fits your chip. Many sizes and pocket depth available.
See accessory page for wide assortment of covers, clips and film and Tyvek® inserts.

INFO

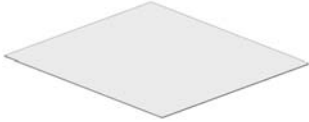
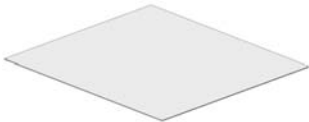
- Note 1: WP2 outline 2.0 x 2.0 inch (50.8 x 50.8mm).
- Note 2: Black Clip Surface Resistivity 10³~10⁶ Ohms/Square
- Note 3: Natural color Clip is not static protective
- Note 4: Standard temperature rating is 70°C.

Description	Application	Quick View	Color	Tray Part Number
<p style="text-align: center;">Tyvek® Insert</p> <p>Anti-Static Surface Resistivity $10^{11} \sim 10^{12}$ Ohms/SQ</p>	Place 1 or 2 Sheets between Top of chip and the cover	 Thickness 0.15mm (0.006")	White	WP2-INSERT-TYVEK
<p style="text-align: center;">Polyethylene Film Insert</p> <p>Dissipative Surface Resistivity $10^6 \sim 10^{10}$ Ohms/SQ</p>	Place 1 or 2 Sheets between Top of chip and the cover	 Thickness 0.20mm (0.008")	White	WP2-INSERT-POLY
<p style="text-align: center;">Self-Adhesive Preprinted Label</p>	Attach to top cover. Hand write the chip description with a pen		White	WP2-LABEL-PP

At-A-Glance Exploded View



Contact TopLine for cover that best fits your chip
See accessory page for wide assortment of covers, clips and film and Tyvek® inserts.

JEDEC JIG TRAY For 2" Waffle Pack For Pick and Place

Simple to use. Just mount 10x 2" waffle packs into JIG-TRAY

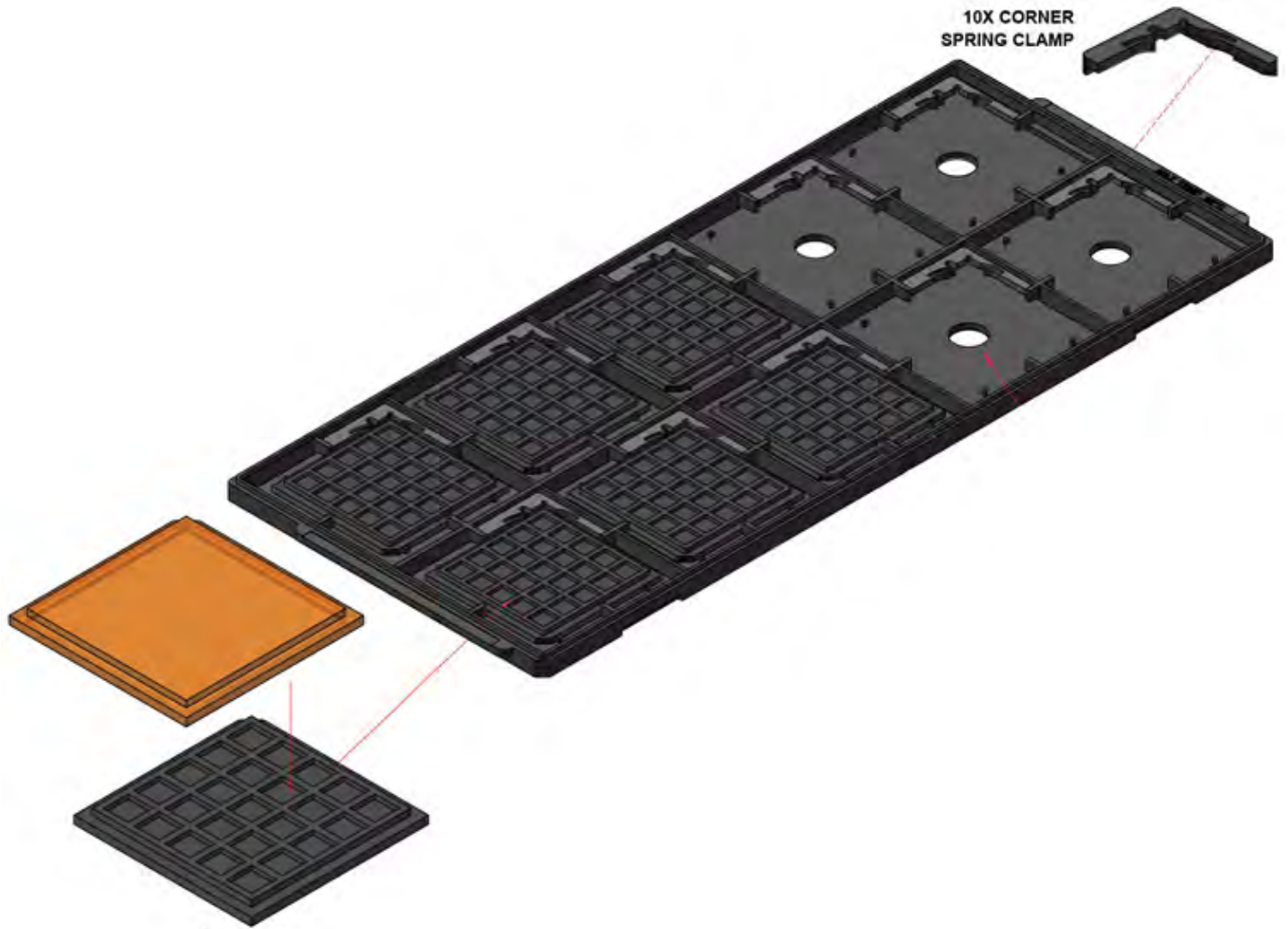

Order: WP2-JIGTRAY-E

Enhanced version with
Corner spring clips.
Holds waffle packs more securely

INFO

Note 1: JIG-TRAY is ESD Safe.

Note 2: Converts standard 2" waffle packs into JEDEC format for machine pick and place.

4" Waffle Pack IC CHIP TRAY Square Components

Pocket Square Size	QTY Pockets	MATRIX Row-Column	Pocket Depth	Tray Part Number
2.2 mm SQ	400	20 x 20	0.64mm	WP4-2.18x2.18x.64B
3.2 mm SQ	324	18 x 18	1.0mm	WP4-3.18x3.18x1.0B
4.0 mm SQ	256	16 x 16	0.61mm	WP4-4.0x4.0x.61B
4.4 mm SQ	196	14 x 14	1.27mm	WP4-4.4x4.4x1.27B
5.2 mm SQ	144	12 x 12	2.0mm	WP4-5.2x5.2x2.0B
6.3mm SQ	121	11 x 11	2.0mm	WP4-6.3x6.3x2.0B
7.6 mm SQ	81	9 x 9	1.27mm	WP4-7.6x7.6x1.27B
8.3mm SQ	64	8 x 8	1.6mm	WP4-8.3x8.3x1.6B
8.7 mm SQ	64	8 x 8	0.64mm	WP4-8.7x8.7x0.64B
10.1 mm SQ	49	7 x 7	0.76mm	WP4-10.1x10.1x.76B
12.7 mm SQ	36	6 x 6	2.5mm	WP4-12.7x12.7x2.5B
13.2 mm SQ	36	6 x 6	1.0mm	WP4-13.2x13.2x1.0B
15.2mm SQ	25	5 x 5	0.76mm	WP4-15.2x15.2x.76B
16.6 mm SQ	16	4 x 4	0.76mm	WP4-16.6x16.6x.76B
18.8 mm SQ	16	4 x 4	2.5mm	WP4-18.8x18.8x2.5B
19.0 mm SQ	16	4 x 4	1.5mm	WP4-19x19x1.5B
22.8 mm SQ	9	3 x 3	1.0mm	WP4-22.8x22.8x1.0B
25.3 mm SQ	9	3 x 3	3.3mm	WP4-25.3x25.3x3.3B
39 mm SQ	4	2 x 2	2.8mm	WP4-39x39x2.8B

Example pocket sizes listed above. Many other sizes available. Contact TopLine.

At-A-Glance

TRAY



Cover



CLIP



Contact TopLine for tray pocket size that best fits your chip. Many sizes and pocket depth available. See accessory page for wide assortment of covers, clips and film and Tyvek® inserts.

INFO

- Note 1: WP4 outline 4.0 x 4.0 inch (100 x 100mm).
- Note 2: Standard tray color is Black. Surface Resistivity $10^3 \sim 10^6$ Ohms/Square
- Note 3: Normally one cover is clipped to one tray. Special clips available to stack five or ten trays.
- Note 4: Dissipative polyethylene inserts or anti-static Tyvek® inserts can be placed between the die and cover.
- Note 5: Standard temperature rating is 70°C.

Pocket Rectangular	QTY Pockets	MATRIX Row-Column	Pocket Depth	Tray Part Number
1.6 x 2.4mm	546	21 x 26	0.51mm	WP4-2.4x1.68x.51B
2.5 x 2.8 mm	529	23 x 23	0.61mm	WP4-2.8x2.54x.61B
2.4 x 4.2 mm	315	15 x 21	0.64mm	WP4-4.2x2.44x.64B
2.3 x 4.4 mm	375	15 x 25	0.51mm	WP4-4.4x2.29x.51B
4.3 x 5.0 mm	168	12 x 14	0.51mm	WP4-5.0x4.3x.51B
3.7 x 5.1 mm	252	14 x 18	0.51mm	WP4-3.7x5.08x.51B
4.8 x 5.1 mm	144	12 x 12	0.64mm	WP4-4.8x5.08x.64B
4.5 x 6.1 mm	180	12 x 15	0.51mm	WP4-4.5x6.1x.51B
2.0 x 7.25 mm	207	9 x 23	1.19mm	WP4-7.25x2.0x1.19B
4.0 x 7.5mm	135	9 x 16	0.64mm	WP4-7.5x4.0x.64B
5.1x 8.4mm	72	8 x 9	0.64mm	WP4-8.8x5.1x.64B
6.4x 10.2 mm	70	10 x7	0.64mm	WP4-6.4x10.2x.64B
7.0 x 12.4mm	60	6 x 10	0.89mm	WP4-12.4x7.0x.89B
10.3 x 11.3 mm	42	6 x 7	1.2mm	WP4-10.3x11.3x1.2B
12.6 x 17.4 mm	24	4 x 6	0.69mm	WP4-12.6x17.4x.69B
13.5 x 18.5 mm	20	4 x 5	2.5mm	WP4-13.5x18.5x2.5B
12.7 x 20 mm	12	3 x 4	1.7mm	WP4-20x12.7x1.7B
17.3 x 20.3 mm	16	4 x 4	1.0mm	WP4-20.3x17.3x1.0B

Example pocket sizes listed above. Many other sizes available. Contact TopLine.

At-A-Glance

TRAY



Cover



CLIP



Contact TopLine for tray pocket size that best fits your chip
See accessory page for wide assortment of covers, clips and film and Tyvek® inserts.

INFO

- Note 1: WP4 outline 4.0 x 4.0 inch (100 x 100mm).
- Note 2: Standard tray color is Black. Surface Resistivity 10³ ~ 10⁶ Ohms/Square
- Note 3: Normally one cover is clipped to one tray. Special clips available to stack five or ten trays.
- Note 4: Dissipative polyethylene inserts or anti-static Tyvek® inserts can be placed between the die and cover.
- Note 5: Standard temperature rating is 70°C.

Description	Height Adder To Depth of Tray Pocket	Side View	Color	Tray Part Number
Standard Cover	Seals Flush Tight		Black	WP4-COVER
Special Extension Cover For Tall Components	0.25mm 0.010-inch		Black	WP4-0.25mm-COVER
	1.7mm 0.070-inch		Black	WP4-1.7mm-COVER
	2.0mm 0.080-inch		Black	WP4-2.0mm-COVER

At-A-Glance

Cover

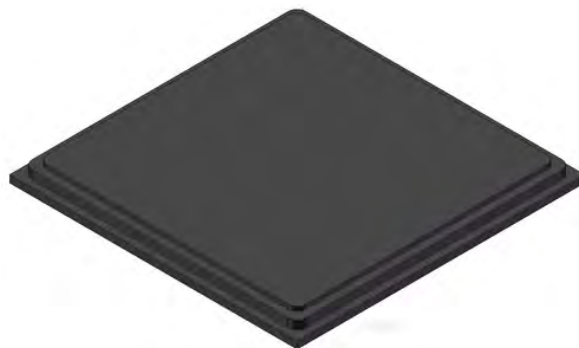

Contact TopLine for cover that best fits your chip
 See accessory page for wide assortment of covers, clips and film and Tyvek® inserts.

INFO

- Note 1: WP4 outline 4.0 x 4.0 inch (100 x 100mm).
- Note 2: Standard cover color is Black. Surface Resistivity $10^3 - 10^6$ Ohms/Square
- Note 3: Standard temperature rating is 70°C.

Description	Nbr Trays	Quick View	Color	Tray Part Number
2-piece Clips	STANDARD Holds 1-tray And 1-cover Order 2x Clips		Black	WP4-CLIP1-B
			Natural	WP4-CLIP-N
	SPECIAL Holds 1-tray And 1-Tray Order 2x Clips		Black	WP4-CLIP-TRAY-TRAY-B
			Natural	WP4-CLIP-TRAY-TRAY-N
	SPECIAL Holds 6-trays And 1-cover Order 2x Clips		Black	WP4-CLIP6-B
			Natural	WP4-CLIP6-N
1-piece Clip	SPECIAL Holds 1-tray And 1-tray Order 1x Clip		Black	WP4-CLIP-TRAY-TRAY-X

At-A-Glance

1-Piece Clip



2-Piece Clip







Stacking 2-Piece Clip

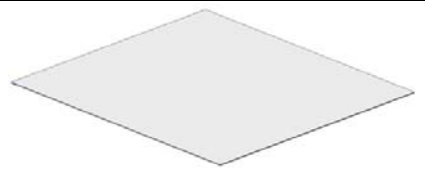

Contact TopLine for clips that best fits your needs.
See accessory page for wide assortment of covers, clips and film and Tyvek® inserts.

INFO

- Note 1: WP4 outline 4.0 x 4.0 inch (100 x 100mm).
- Note 2: Black Clip Surface Resistivity $10^3 \sim 10^6$ Ohms/Square
- Note 3: Natural color Clip is not static protective
- Note 4: Standard temperature rating is 70°C.

Description	Application	Quick View	Color	Tray Part Number
Tyvek® Insert Anti-Static Surface Resistivity $10^{11} \sim 10^{12}$ Ohms/SQ	Place 1 or 2 Sheets between Top of chip and the cover	 Thickness 0.15mm (0.006")	White	WP4-INSERT-TYVEK
Polyethylene Film Insert Dissipative Surface Resistivity $10^6 \sim 10^{10}$ Ohms/SQ	Place 1 or 2 Sheets between Top of chip and the cover	 Thickness 0.20mm (0.008")	White	WP4-INSERT-POLY
Foam Void Filler Conductive Surface Resistivity $10^3 \sim 10^6$ Ohms/SQ	Place 1 Sheet between Top of chip, Tyvek and the cover		Black	WP4-FOAM-SOFT-3.5A
Self-Adhesive Preprinted Label	Attach to top cover. Hand write the chip description with a pen		White	WP4-LABEL-PP

At-A-Glance Exploded View

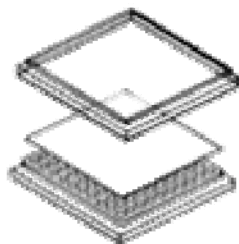

Contact TopLine for cover that best fits your chip
See accessory page for wide assortment of covers, clips and film and Tyvek® inserts.

JEDEC JIG TRAY For 4" Waffle Pack For Pick and Place

Simple to use. Just mount 3x 4" waffle packs into JIG-TRAY

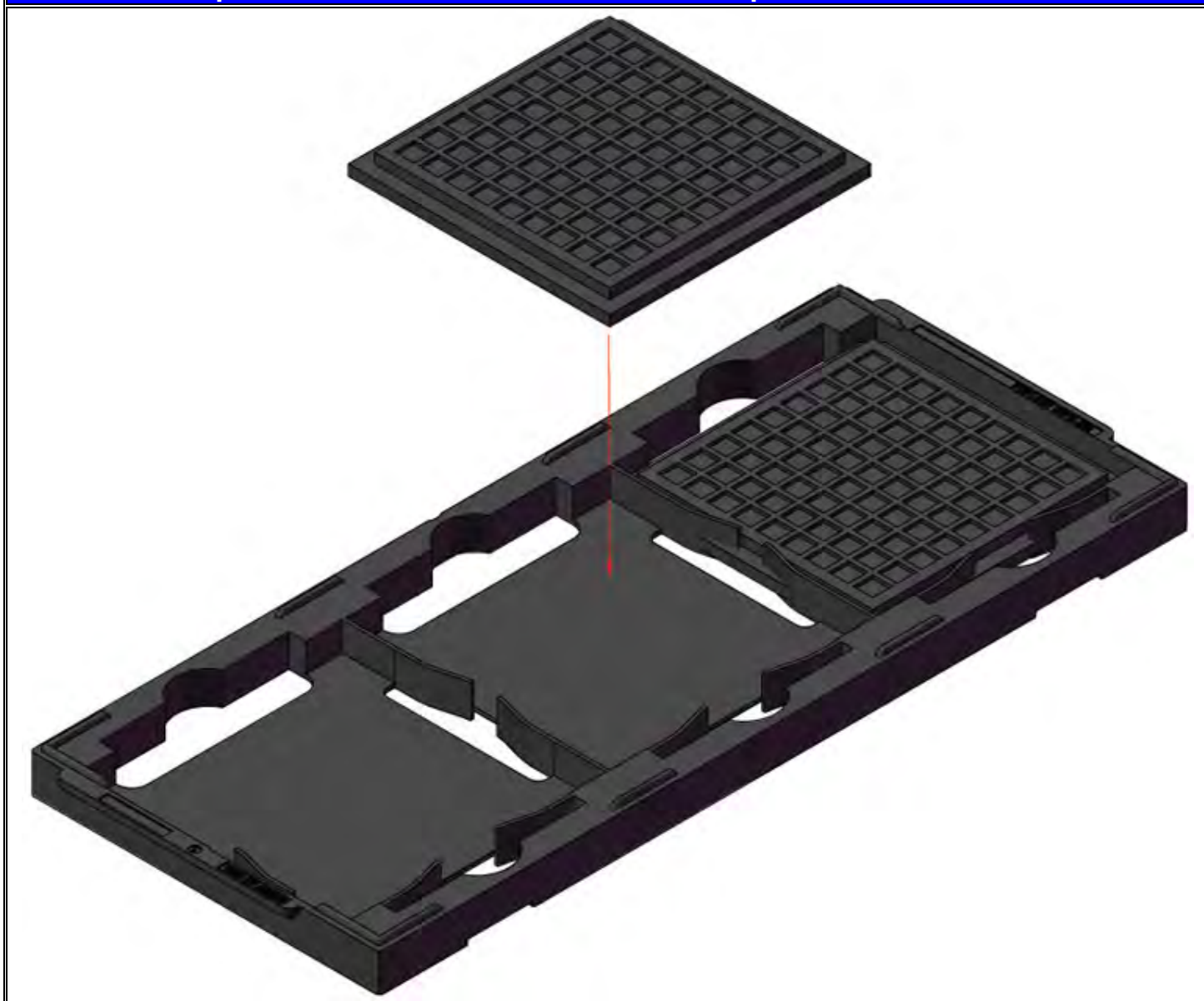

Order: WP4-JIGTRAY-E

Enhanced version with Spring clips.
Holds waffle packs more securely

INFO

Note 1: JIG-TRAY is ESD Safe.

Note 2: Converts standard 4" waffle packs into JEDEC format for machine pick and place.

EUROPE***Austria***

Factronix
Tel +49 8153-90 664-0
office@factronix.com

Belgium

Rotec
Tel +32 (0) 14 40 21 50
info@rotec.be

France

ATOO electronics
Tel +33 (02) 99.08.01.90
info@atoo-electronics.com

Germany

Factronix
Tel +49 8153-90 664-0
office@factronix.com

Ireland

IPP Ltd
Tel +353 21-423 2233
sales@ippGroupLtd.com

Italy (North)

Cepeltalia
Tel +39 02-4073747
info@cepeitalia.it

Italy (South)

Cepe Forniture
Tel +39 075.95.61.86
cepeelettronica@virgilio.it

Finland

Koodiportti Oy
Tel: +358 040 - 5479 338
jarno.pyoria@koodiportti.com

Netherlands

Rotec
Tel +32 (0) 14 40 21 52
info@rotec.be

Poland

Semicon
Tel +48 (22) 615-64-31
info@semicon.com.pl

Spain

Necten
Tel +34 916 942 409
necten@necten.com

Switzerland

Hilpert
Tel +41 56 483 25 25
office@hilpert.ch

Turkey

Factronix
Tel +90 (362) 54 391 23
s.yamanlar@Factronix.com

United Kingdom

Kaisertech
Tel +44-(0)23-8065-0065
sales@kaisertech.co.uk

Middle East and Africa***Israel***

G-Suit
Tel +972 (08)-910-8878
G-Suit@TopLine.tv

South Africa

Test & Rework
Tel +27-11-704-6677
sales@TestAndRework.co.za

ASIA and Pacific

Hong Kong

Borison Automation
Tel +852 2687-0948
TopLine@borison.com

Japan

ADY
Tel +81-06-6397-0412
TopLine@ADY-JP.com

Taiwan

Zinby
Tel +886-2-8228-0880
Sales1@zinby.com.tw

China

Jamron
Tel +86-21-5109 7866
info@jamron.com

Korea

Jin Trading
Tel +82 (031) 499-5633
Jeong6651@naver.com

Vietnam

Dou Yee Enterprises
Tel +65-6444-2678
marketing@douyee.com

China

Dou Yee
Tel +86-21-5899-4619
marketing@douyee.com

Malaysia

Dou Yee Enterprises
Tel +65-6444-2678
marketing@douyee.com

Philippines

TopLine
Tel +1-478-451-5000
Tanaka@TopLine.tv

Indonesia

Dou Yee Enterprises
Tel +65-6444-2678
marketing@douyee.com

Singapore

Dou Yee Enterprises
Tel +65-6444-2678
marketing@douyee.com

Australia

Suba Engineers
Tel +61-2-9790-0900
Tel +61-3-9583-9311
SubaSyd@suba.com.au

India

EMST Marketing Pvt. Ltd
Tel +91 95 955 25010
contact@emstoline.com

Thailand

Dou Yee Enterprises
Tel +65-6444-2678
marketing@douyee.com

New Zealand

Suba Engineers
Tel +61-2-9790-0900
SubaSyd@suba.com.au

Americas

Argentina

TopLine
Tel +1-478-451-5000
Info@TopLine.tv

Brazil

TopLine
Tel +1-478-451-5000
Info@TopLine.tv

Canada, USA, Mexico

TopLine
Tel +1-800-776-9888
Info@TopLine.tv

Small Orders Welcome - Immediate Delivery



JEDEC TRAY

**Waffle Packs
IC Chip Tray**



TopLine®

TopLine Corporation

Tel: +1-800-776-9888
Email: Info@TopLine.tv

www.TopLine.tv/tray.html