

TOP VIEW

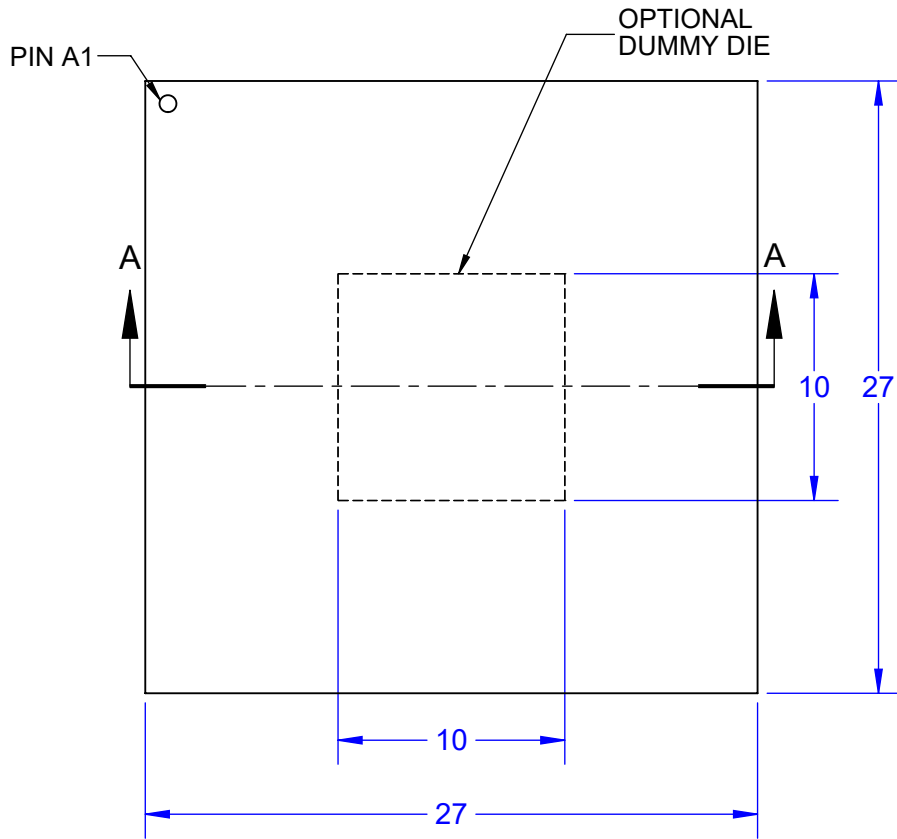

BALL VIEW

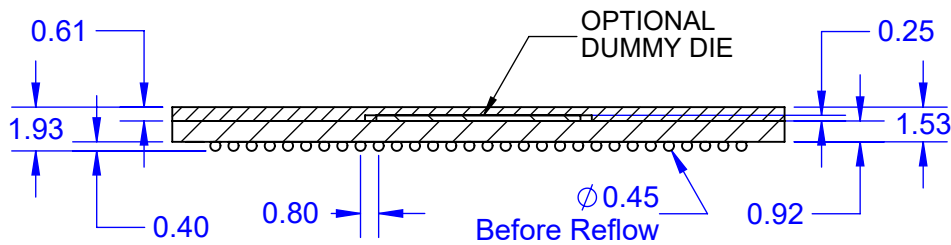
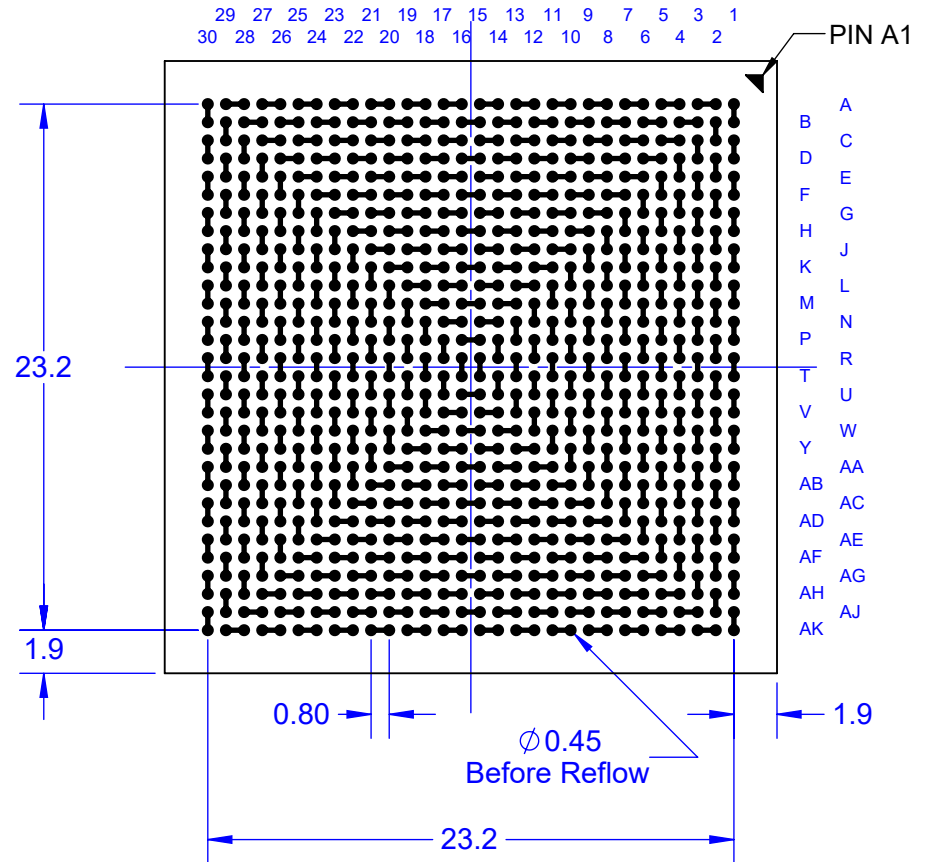

SECTION A-A

Notes: (Unless Otherwise Specified).

- 1) ALL DIMENSIONS ARE IN MM.
- 2) SOLDER BALL ALLOY: SEE PART NUMBER TABLE.
- 3) BALL DIAMETER (BEFORE REFLOW): 0.45mm.
- 4) SOLDER MASK DEFINED PAD OPENING: 0.40mm (16 MIL).
- 5) PAD Cu DIAMETER: 0.508mm (20 MIL).
- 6) SUBSTRATE MATERIAL: BT.
- 7) DUMMY DIE IS OPTIONAL.
- 8) DAISY CHAIN PATTERN (SEE PAGE 2).
- 9) MSL-3 RECOMMENDED BAKING 24 HOURS @ 125°C TO REMOVE MOISTURE PRIOR SOLDERING TO PC BOARD.

PART NUMBER TABLE

PART NUMBER	BALL ALLOY	Pb-FREE	RoHS	Si DIE
BGA900T.8C-DC309D	Sn96.5/Ag3.0/Cu0.5	YES	YES	YES
BGA900T.8-DC309D	Sn63/Pb37	NO	NO	YES

APPROVALS		DATE				
DRAWN	T.Au	5/26/2025				
ENG	M. Hart	5/26/2025	TITLE		BGA900T.8-DC309D DAISY CHAIN DUMMY	
MFG			SCALE		SIZE	DRAWING NO.
QA			3:1		A	583090
CUST						REV
REVISED						C
					DO NOT SCALE DRAWING	
					SHEET 1 OF 4	

BALL VIEW

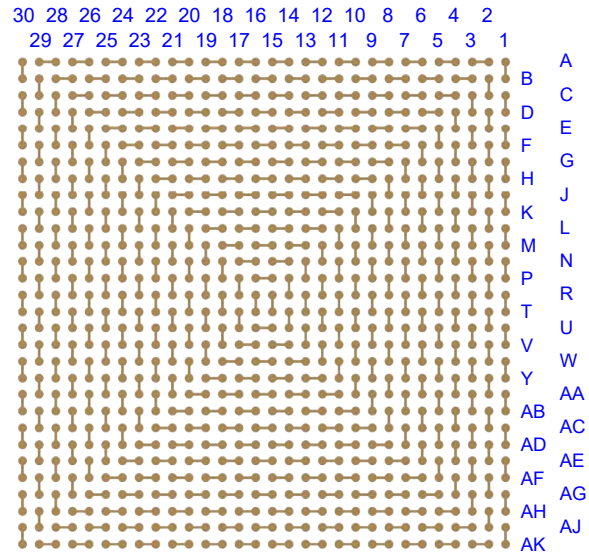

BOTTOM SIDE (TOP X-RAY VIEW)

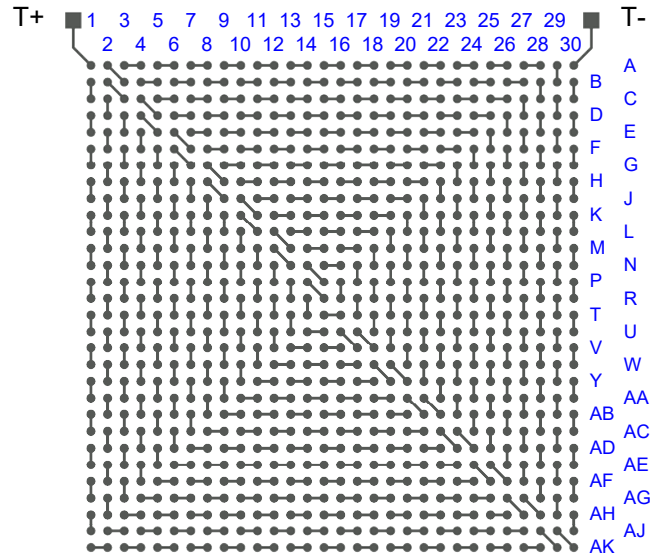
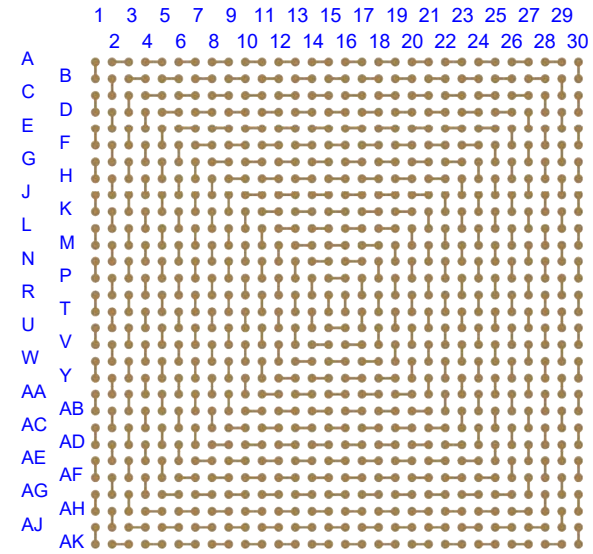

TEST VEHICLE BOARD

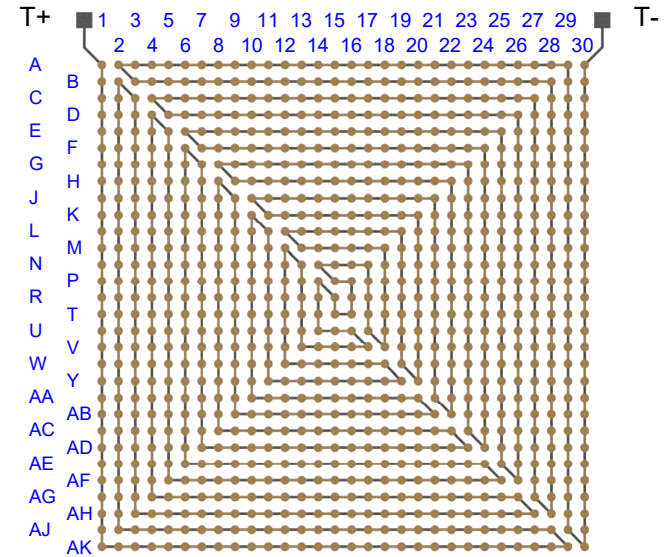

AFTER MOUNTING

Notes:

- 1) PCB BOARD DIMENSIONS ARE PRESENTED ONLY AS A GUIDELINE. DESIGNERS SHOULD USE THEIR OWN EXPERIENCE WHEN DESIGNING PCB.
- 2) PCB Cu BALL PAD DIAMETER 0.508mm (20 MIL).
- 3) PCB DAISY CHAIN TRACING LINE WIDTH 0.152mm (6 MIL).
- 4) SMD (SOLDER MASK DEFINED) PAD OPENING: 0.33mm (13 MIL).

TopLine®			
TITLE		BGA900T.8-DC309D DAISY CHAIN DUMMY	
SCALE	SIZE	DRAWING NO.	REV
3:1	A	583090	C
DO NOT SCALE DRAWING			SHEET 2 OF 4

MODEL

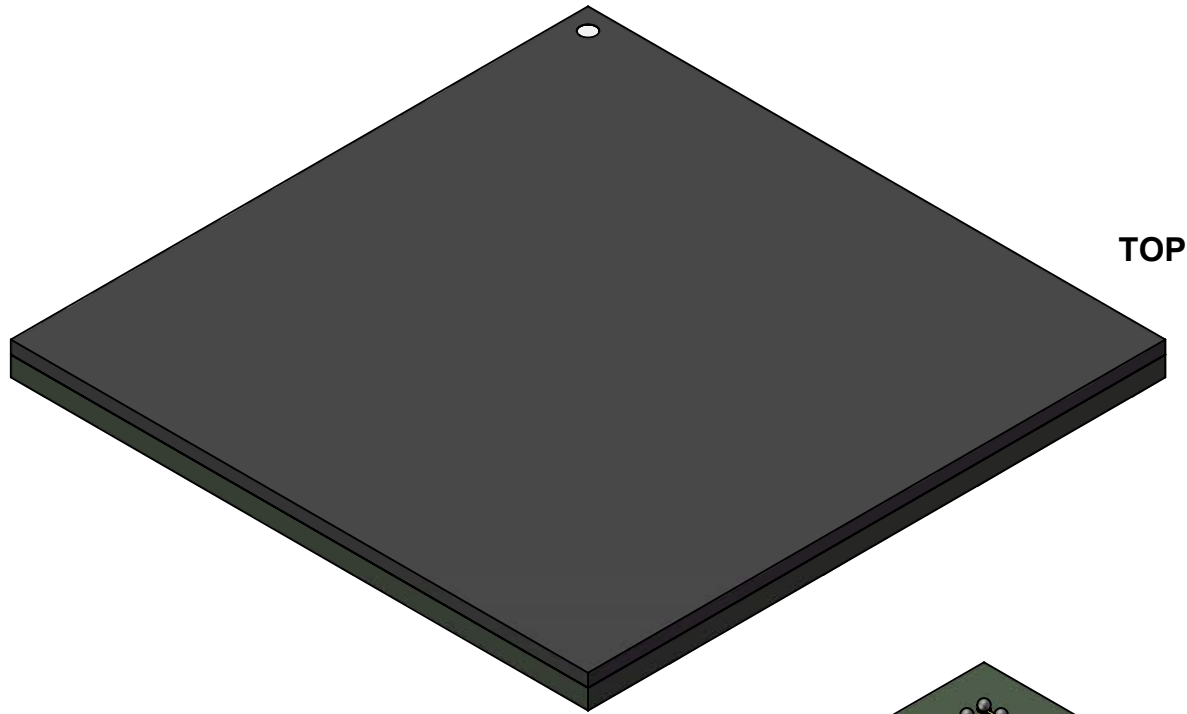

TOP

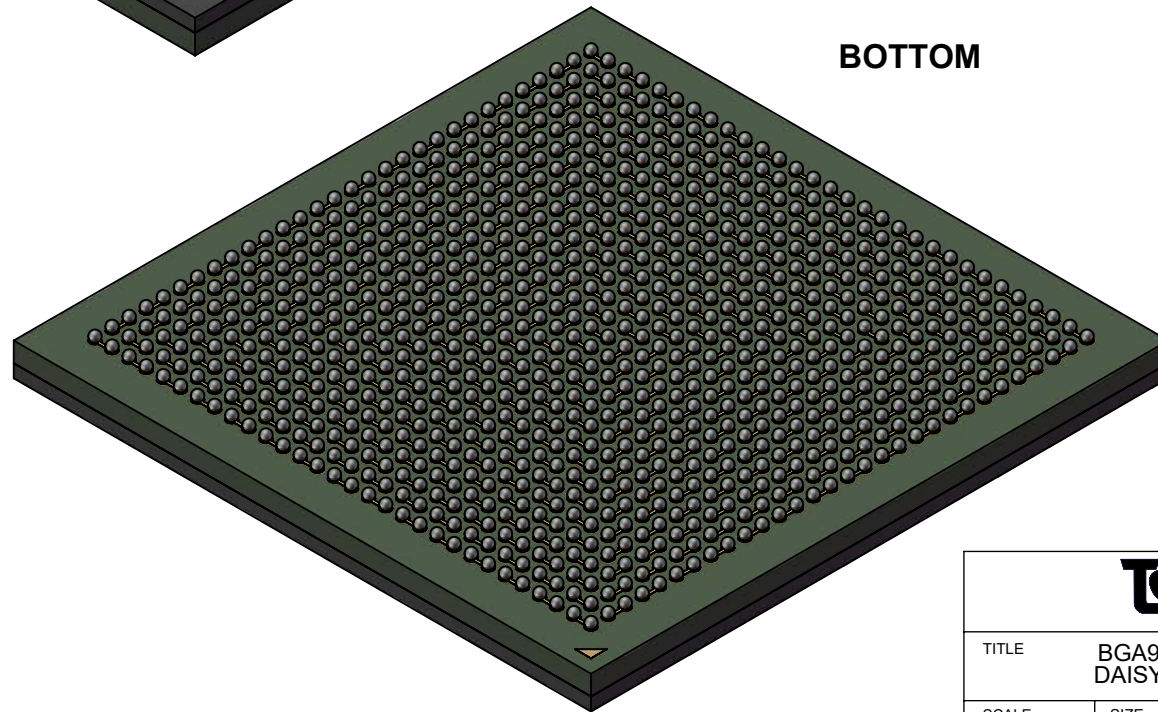

BOTTOM

TopLine[®]

TITLE BGA900T.8-DC309D
DAISY CHAIN DUMMY

SCALE 3:1	SIZE A	DRAWING NO. 583090	REV C
--------------	-----------	-----------------------	----------

DO NOT SCALE DRAWING

SHEET 3 OF 4

**BOTTOM SOLDER MASK
(RIGHT READING)**

30 28 26 24 22 20 18 16 14 12 10 8 6 4 2
29 27 25 23 21 19 17 15 13 11 9 7 5 3 1

A
B
C
D
E
F
G
H
J
K
L
M
N
P
R
T
U
V
W
Y
AA
AB
AC
AD
AE
AF
AG
AH
AJ
AK

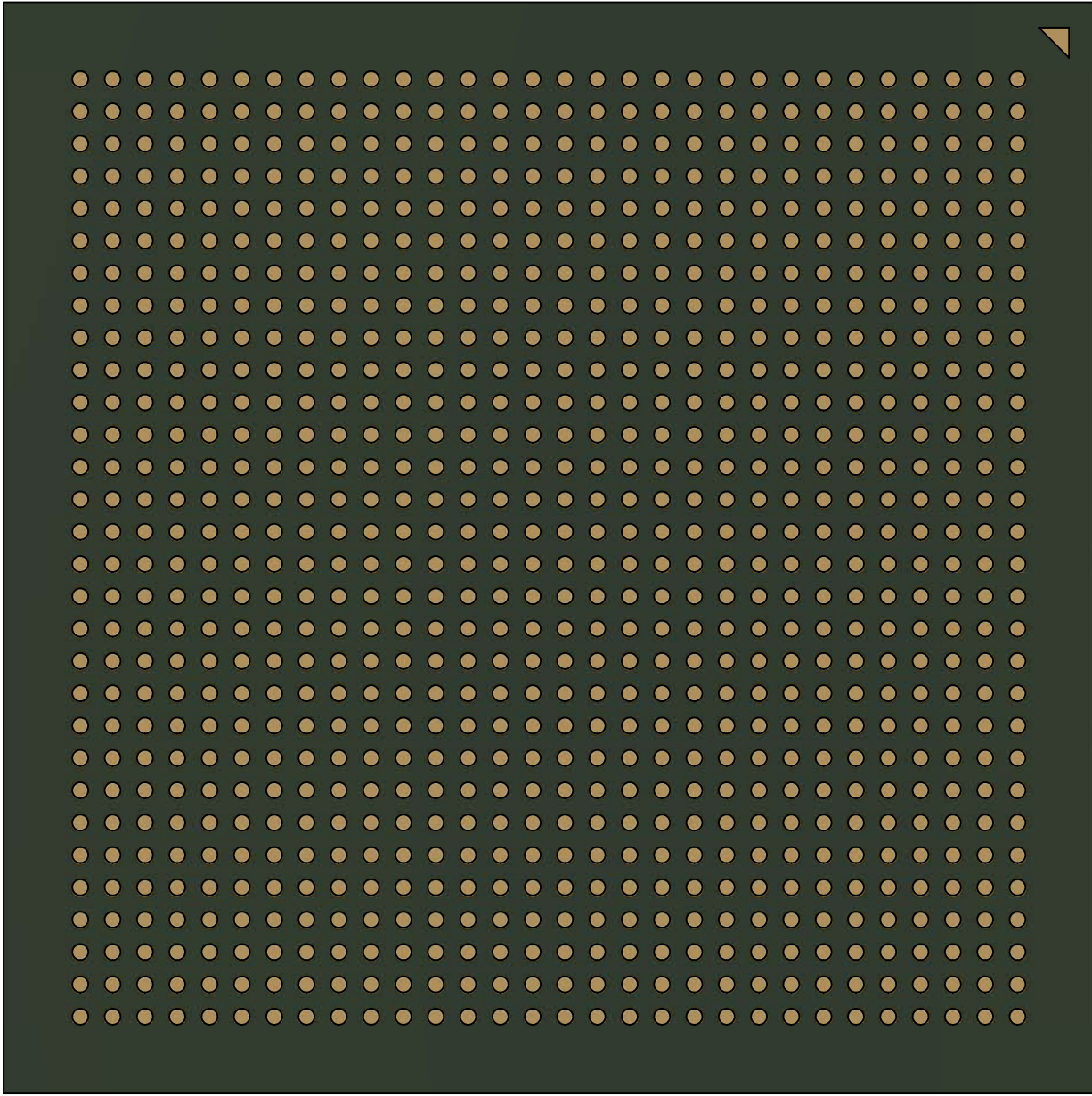

TopLine®			
TITLE BGA900T.8-DC309D DAISY CHAIN DUMMY			
SCALE 3:1	SIZE A	DRAWING NO. 583090	REV C
DO NOT SCALE DRAWING			SHEET 4 OF 4