

TOP VIEW

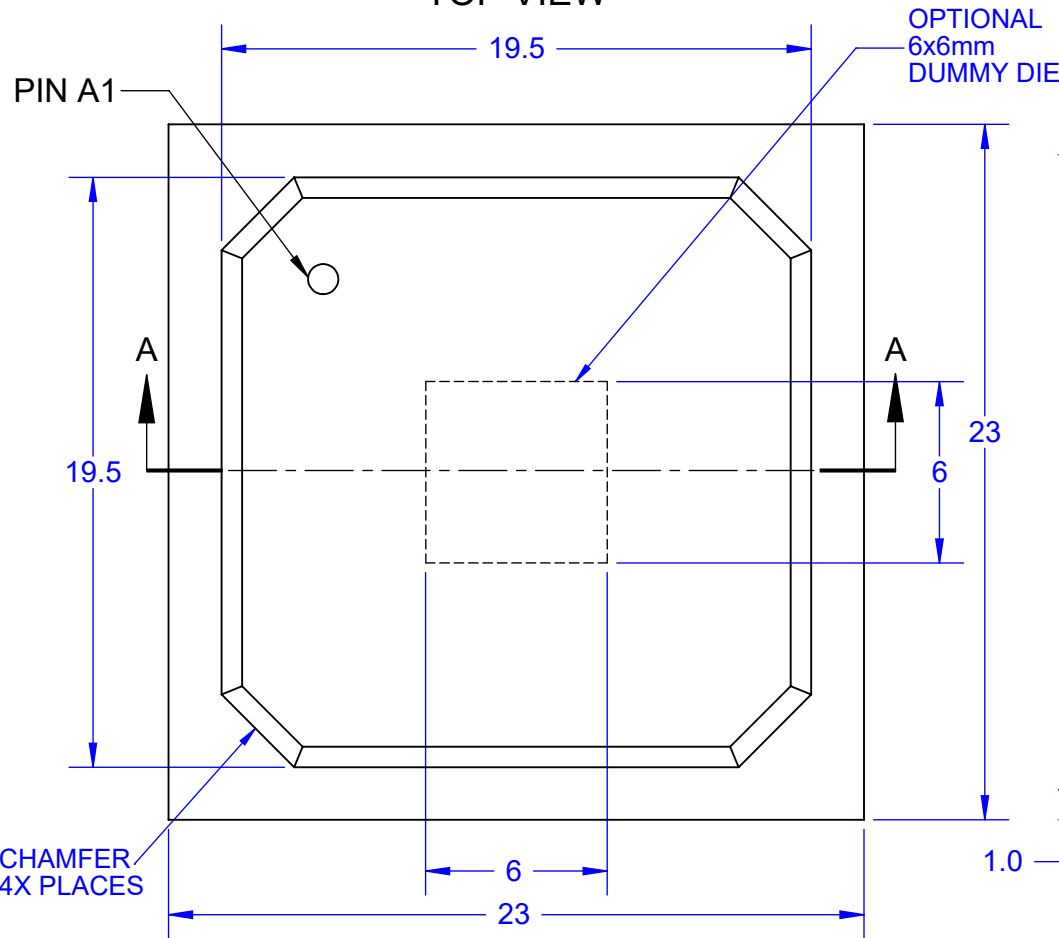

BALL VIEW

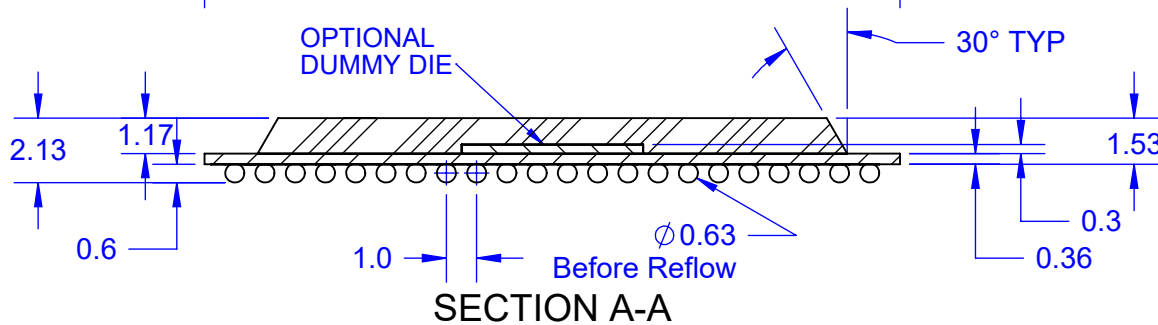
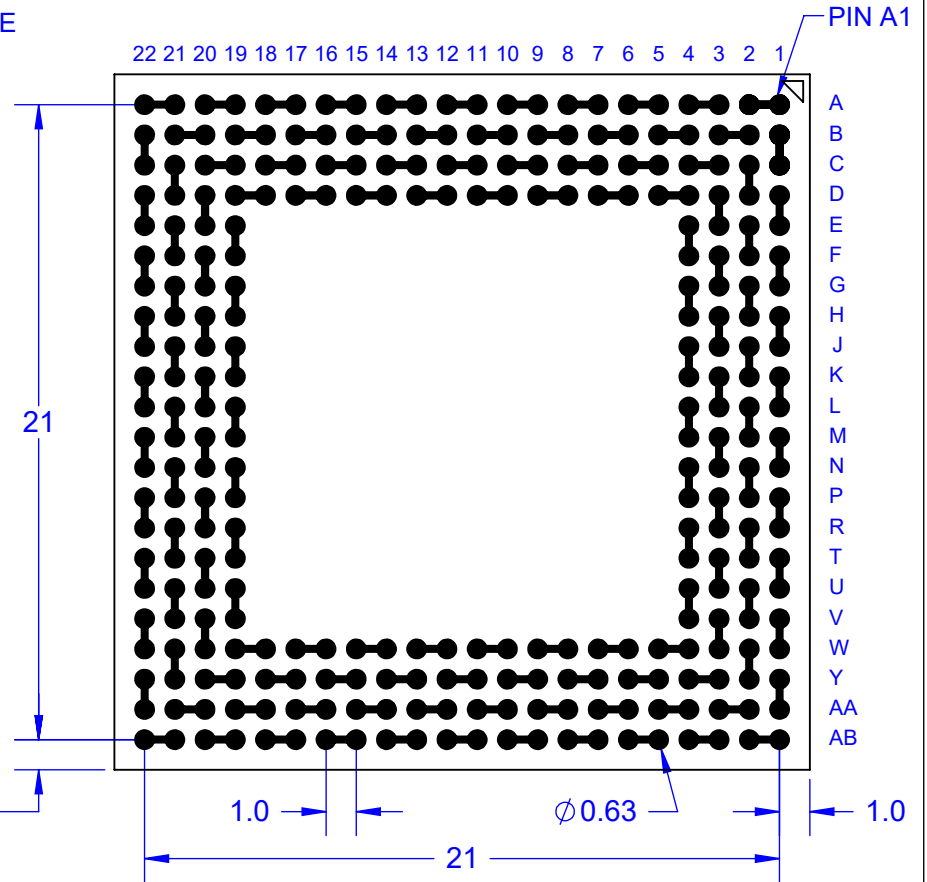

SECTION A-A

Notes: (Unless Otherwise Specified).

- 1) ALL DIMENSIONS ARE IN MM.
- 2) SOLDER BALL ALLOY: SEE PART NUMBER TABLE.
- 3) BALL DIAMETER (BEFORE REFLOW): 0.63mm (25 MIL).
- 4) SOLDER MASK DEFINED PAD OPENING: 0.508 (20 MIL).
- 5) PAD Cu DIAMETER: 0.635 (25 MIL).
- 6) SUBSTRATE MATERIAL: BT.
- 7) DUMMY DIE IS OPTIONAL.
- 8) DAISY CHAIN PATTERN (SEE PAGE 2).
- 9) MSL-3 RECOMMENDED BAKING 24 HOURS @ 125°C TO REMOVE MOISTURE PRIOR SOLDERING TO PC BOARD.

PART NUMBER TABLE

PART NUMBER	BALL ALLOY	BALL CODE	RoHS	Si DIE
BGA288T1.0C-DC221D	Sn96.5/Ag3.0/Cu0.5	SAC305	YES	YES
BGA288T1.0-DC221D	Sn63/Pb37	Sn63	NO	YES

APPROVALS	DATE	TopLine®			
DRAWN T.Au	3/14/2021				
ENG M. Hart	3/14/2021	TITLE BGA288T1.0-DC221D DAISY CHAIN DUMMY			
MFG		SCALE 4:1	SIZE A	DRAWING NO. 512214	REV A
QA		DO NOT SCALE DRAWING			SHEET 1 OF 3
CUST					
REVISED					

BALL VIEW

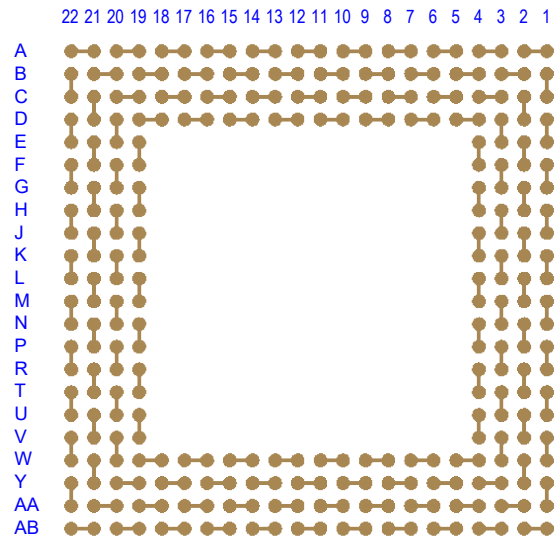

BOTTOM SIDE (TOP X-RAY VIEW)

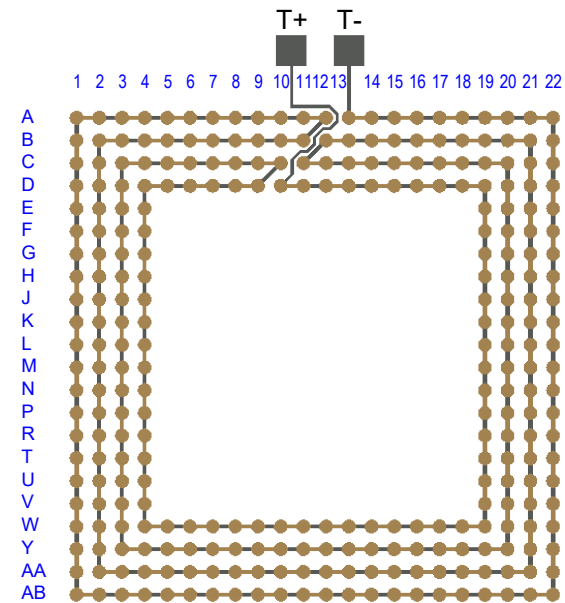
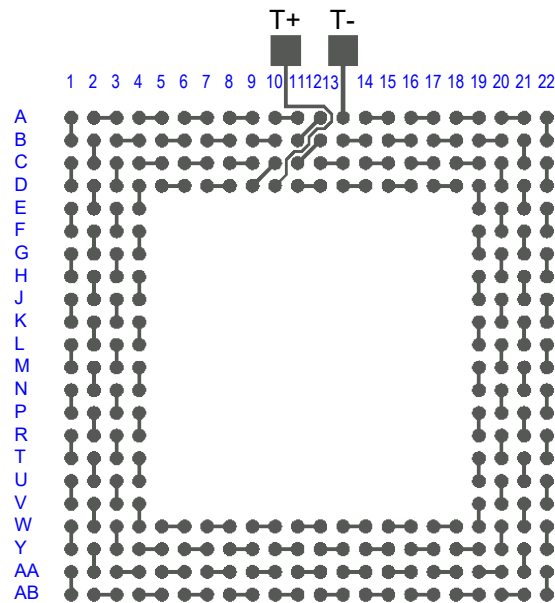
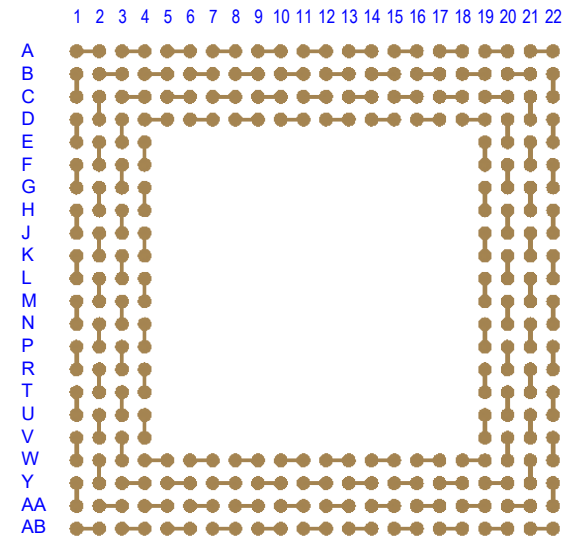

TEST VEHICLE BOARD

AFTER MOUNTING

Notes:

- 1) PCB BOARD DIMENSIONS ARE PRESENTED ONLY AS A GUIDELINE. DESIGNERS SHOULD USE THEIR OWN EXPERIENCE WHEN DESIGNING PCB.
- 2) PCB Cu BALL PAD DIAMETER 0.635 (25 MIL).
- 3) PCB DAISY CHAIN TRACING LINE WIDTH 0.203 (8 MIL).
- 4) SMD (SOLDER MASK DEFINED) PAD OPENING: 0.508 (20 MIL).

TopLine®			
TITLE		BGA288T1.0-DC221D DAISY CHAIN DUMMY	
SCALE	SIZE	DRAWING NO.	REV
4:1	A	512214	A
DO NOT SCALE DRAWING			SHEET 2 OF 3

TOP

MODEL

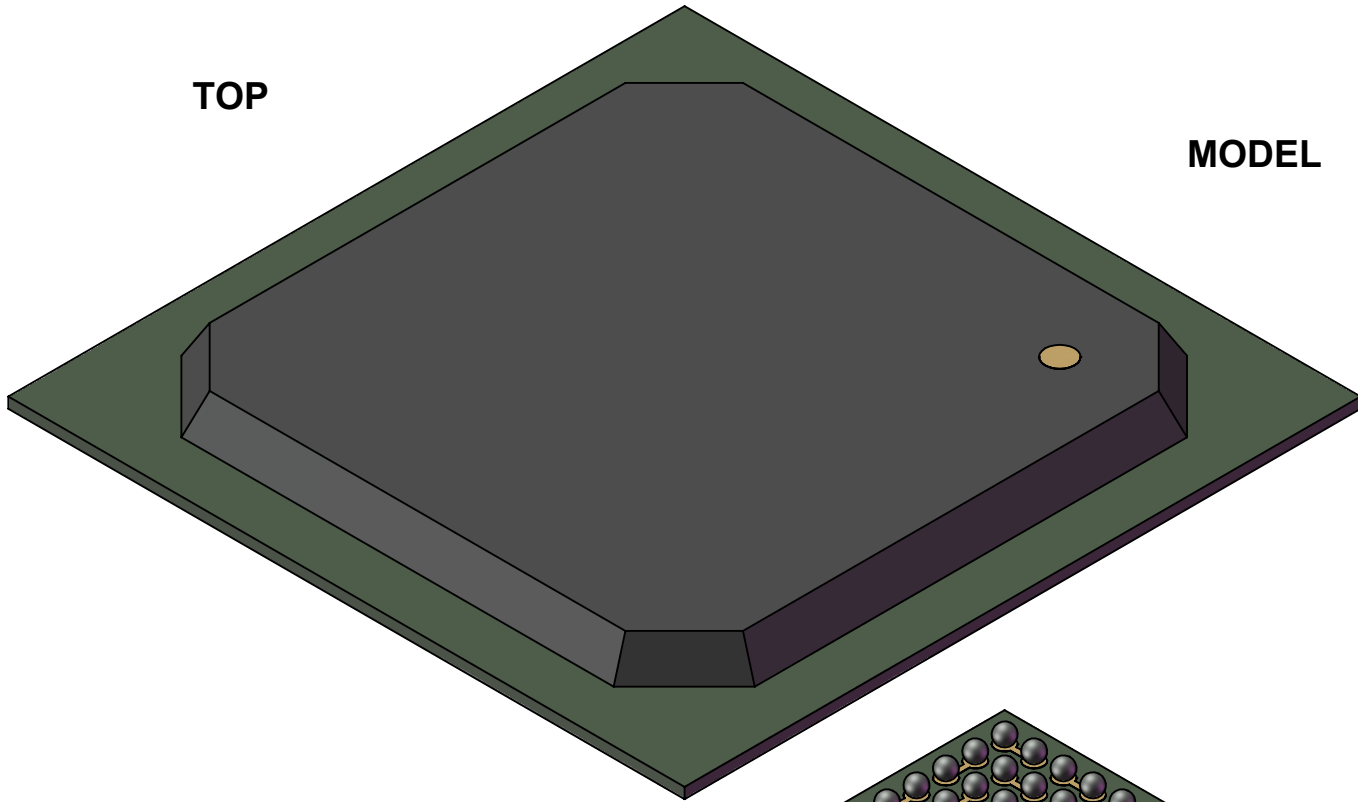

BALL VIEW

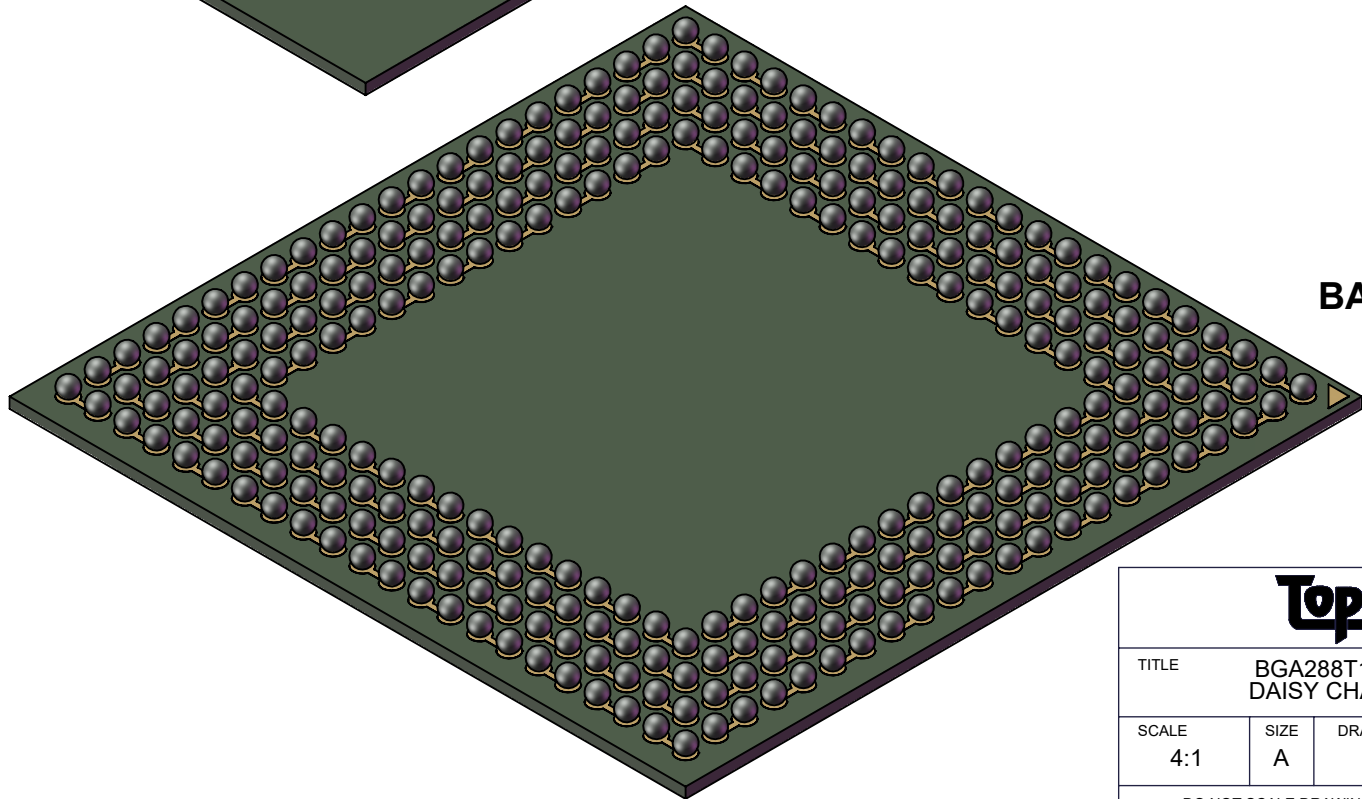

TopLine[®]

TITLE BGA288T1.0-DC221D
DAISY CHAIN DUMMY

SCALE 4:1	SIZE A	DRAWING NO. 512214	REV A
--------------	-----------	-----------------------	----------

DO NOT SCALE DRAWING

SHEET 3 OF 3