

BALL VIEW

34 33 32 31 30 29 28 27 26 25 24 23 22 21 20 19 18 17 16 15 14 13 12 11 10 9 8 7 6 5 4 3 2 1

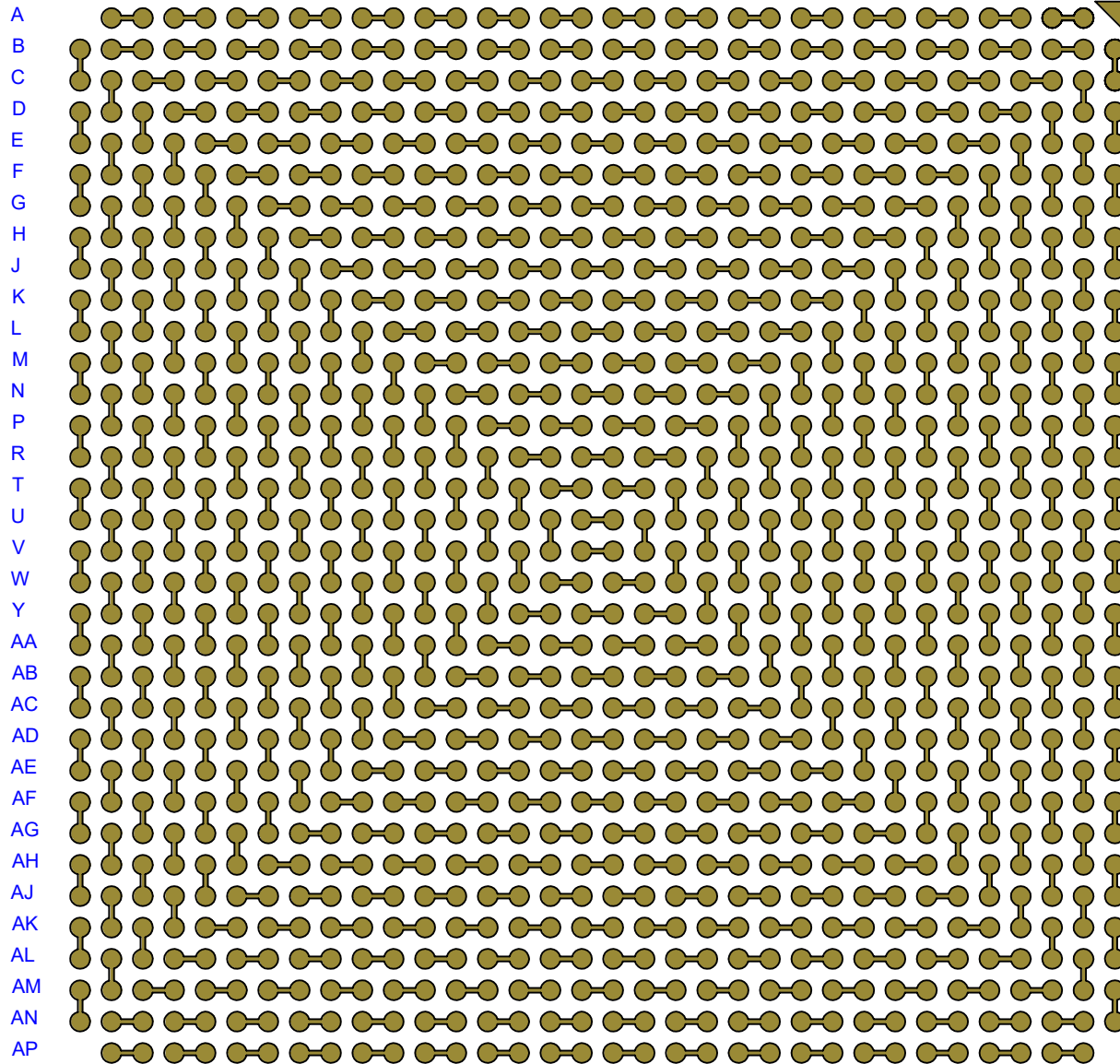

TopLine®			
TITLE		SBGA1152T1.0-DC349D DAISY CHAIN DUMMY	
SCALE	SIZE	DRAWING NO.	REV
4.5:1	A	513445	B
DO NOT SCALE DRAWING			SHEET 3 OF 9

BOTTOM SIDE (TOP X-RAY VIEW)

1 2 3 4 5 6 7 8 9 10 11 12 13 14 15 16 17 18 19 20 21 22 23 24 25 26 27 28 29 30 31 32 33 34

A
B
C
D
E
F
G
H
J
K
L
M
N
P
R
T
U
V
W
Y
AA
AB
AC
AD
AE
AF
AG
AH
AJ
AK
AL
AM
AN
AP

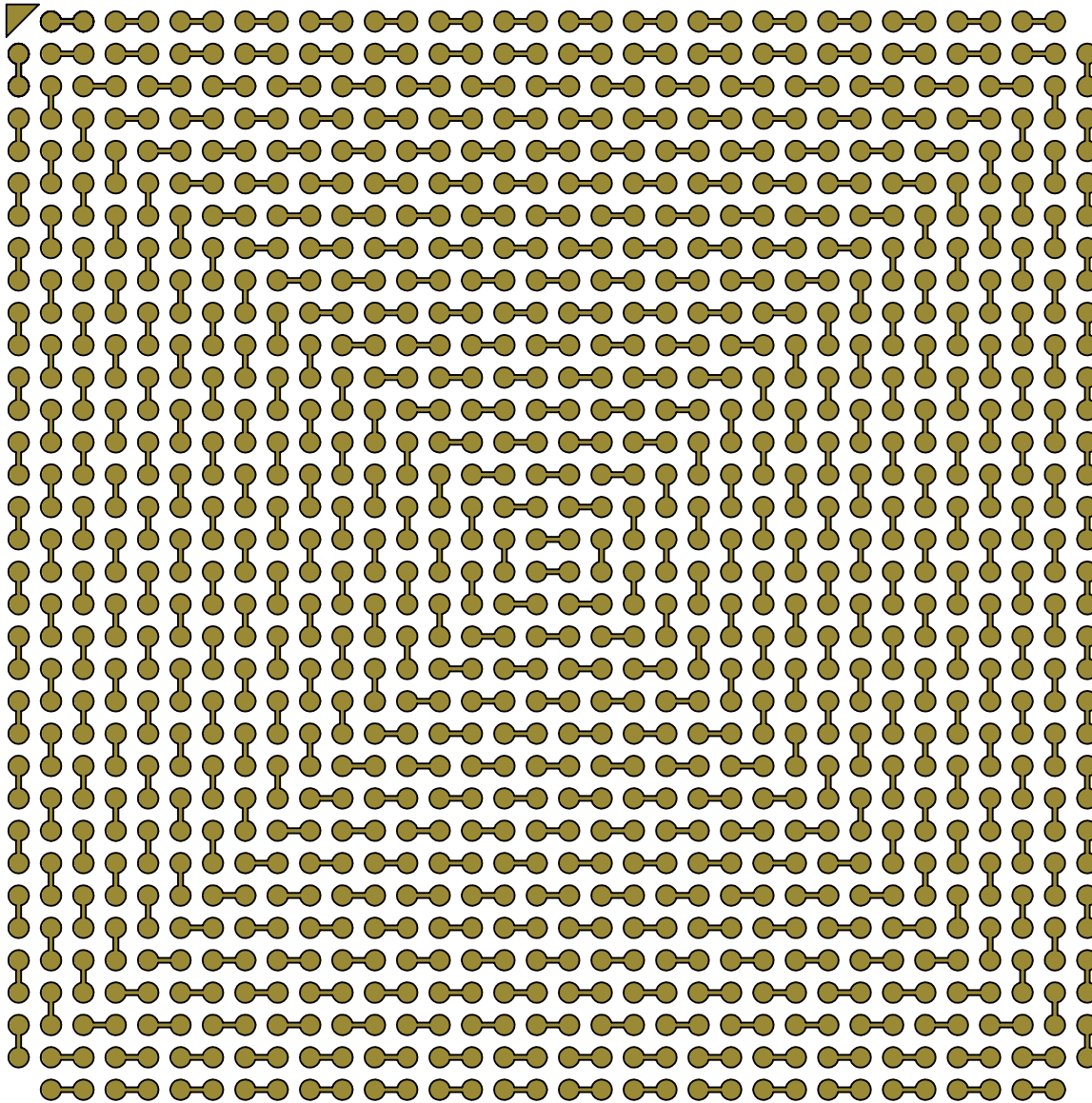

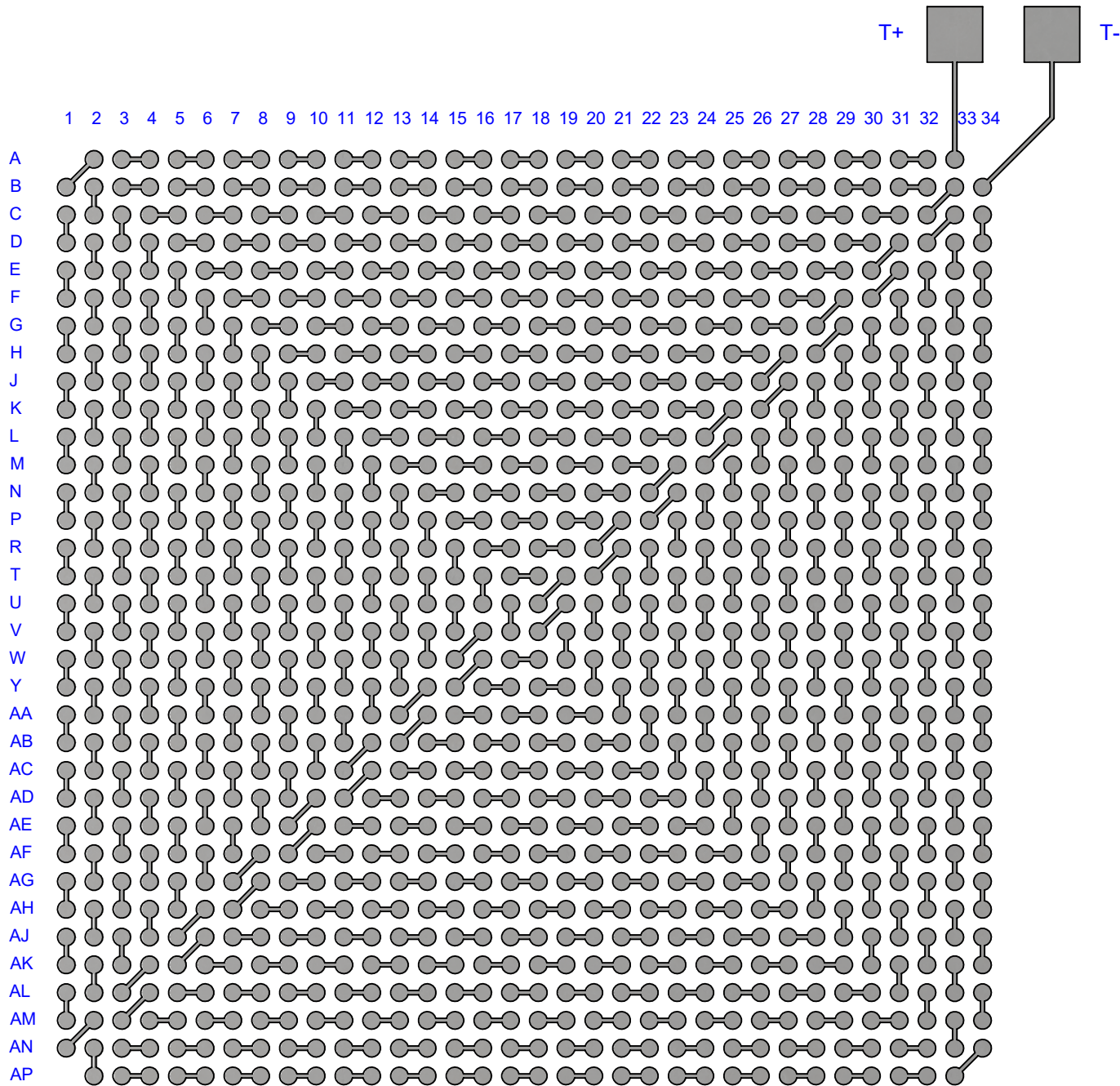

TopLine®			
TITLE		SBGA1152T1.0-DC349D DAISY CHAIN DUMMY	
SCALE	SIZE	DRAWING NO.	REV
4.5:1	A	513445	B
DO NOT SCALE DRAWING			SHEET 4 OF 9

TEST VEHICLE BOARD



TopLine®			
TITLE		SBGA1152T1.0-DC349D DAISY CHAIN DUMMY	
SCALE	SIZE	DRAWING NO.	REV
4.5:1	A	513445	B
DO NOT SCALE DRAWING			SHEET 5 OF 9

AFTER MOUNTING TO TEST BOARD

T+   T-

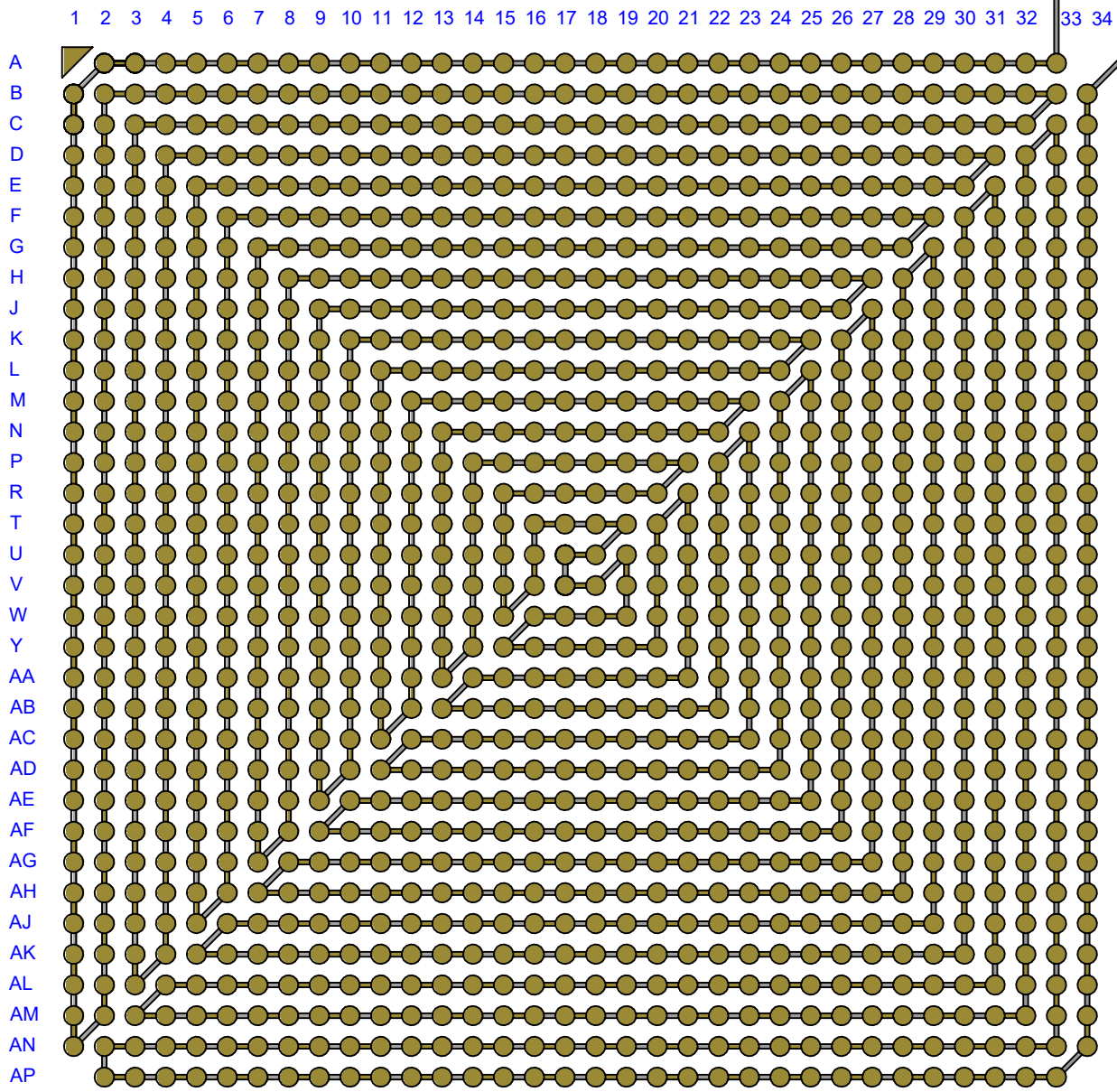

TopLine[®]			
TITLE		SBGA1152T1.0-DC349D DAISY CHAIN DUMMY	
SCALE	SIZE	DRAWING NO.	REV
4.5:1	A	513445	B
DO NOT SCALE DRAWING			SHEET 6 OF 9

HEAT SPREADER

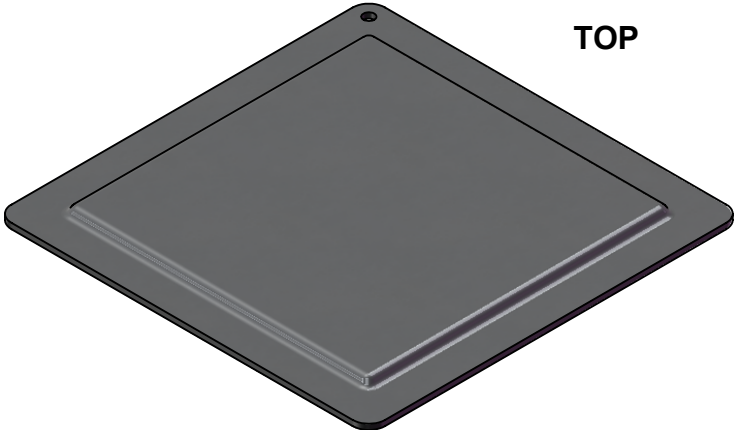
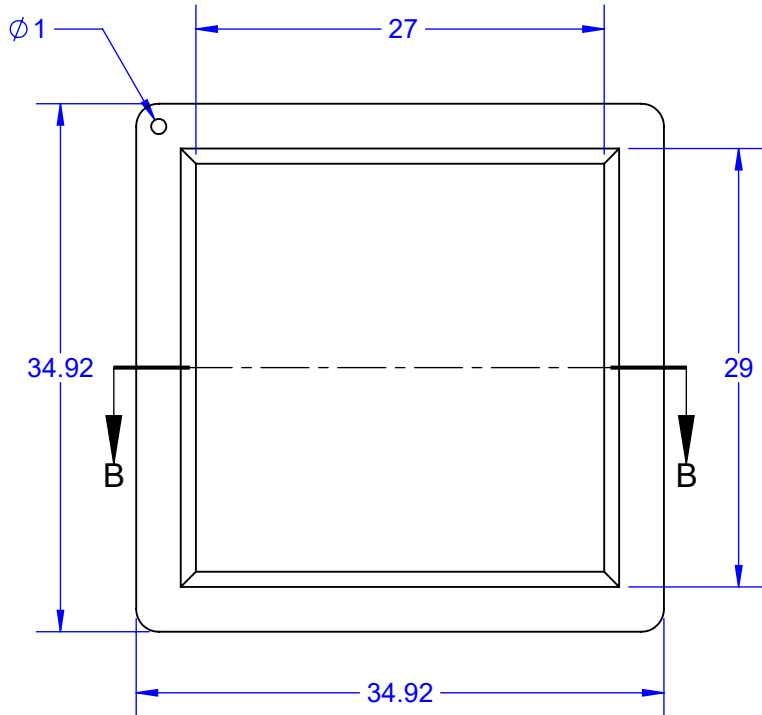

TOP

MODEL

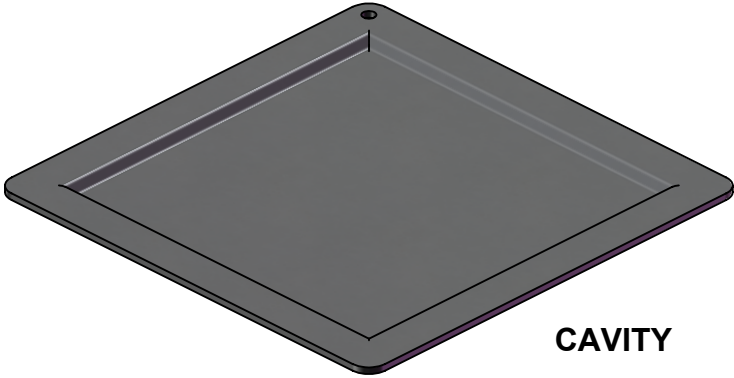

CAVITY

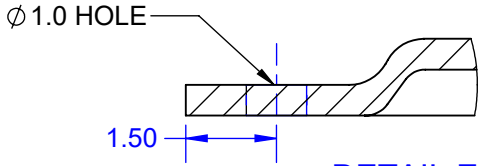

DETAIL E
SCALE 8 : 1

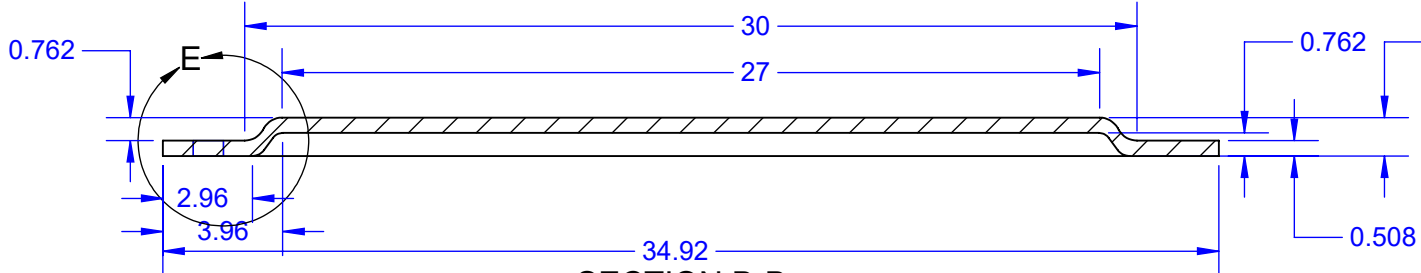

SECTION B-B
SCALE 4 : 1

* ADD 0.13MM SEALANT

TopLine®			
TITLE SBGA1152T1.0-DC349D DAISY CHAIN DUMMY			
SCALE 2:1	SIZE A	DRAWING NO. 513445	REV B
DO NOT SCALE DRAWING			SHEET 7 OF 9

MODEL

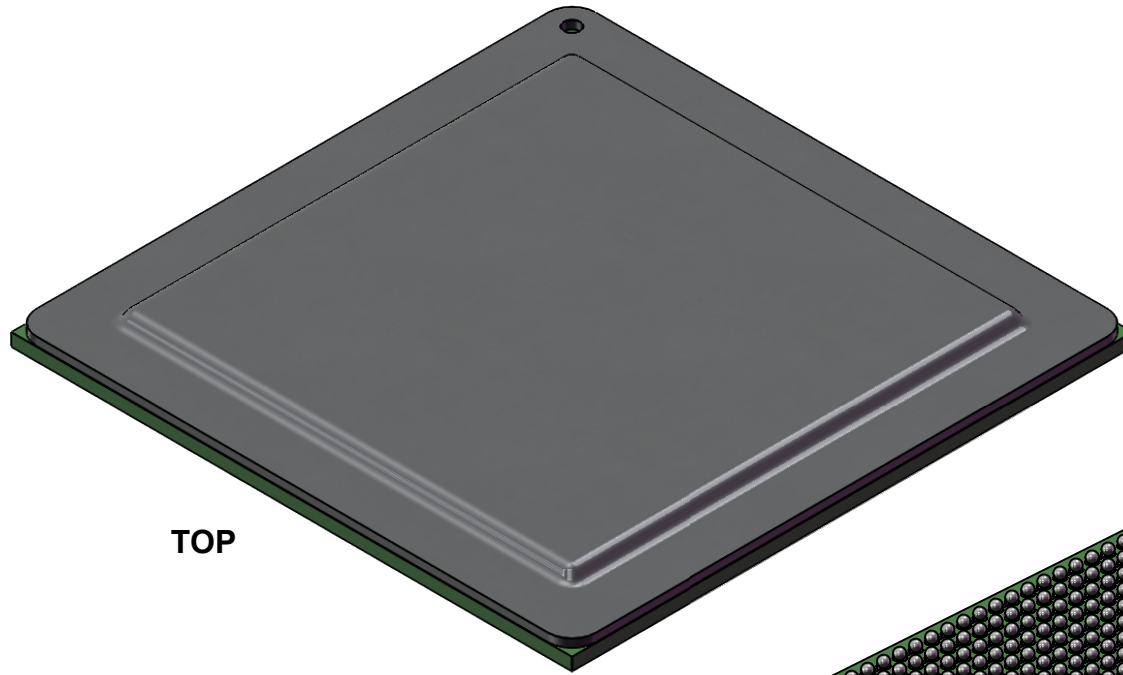

TOP

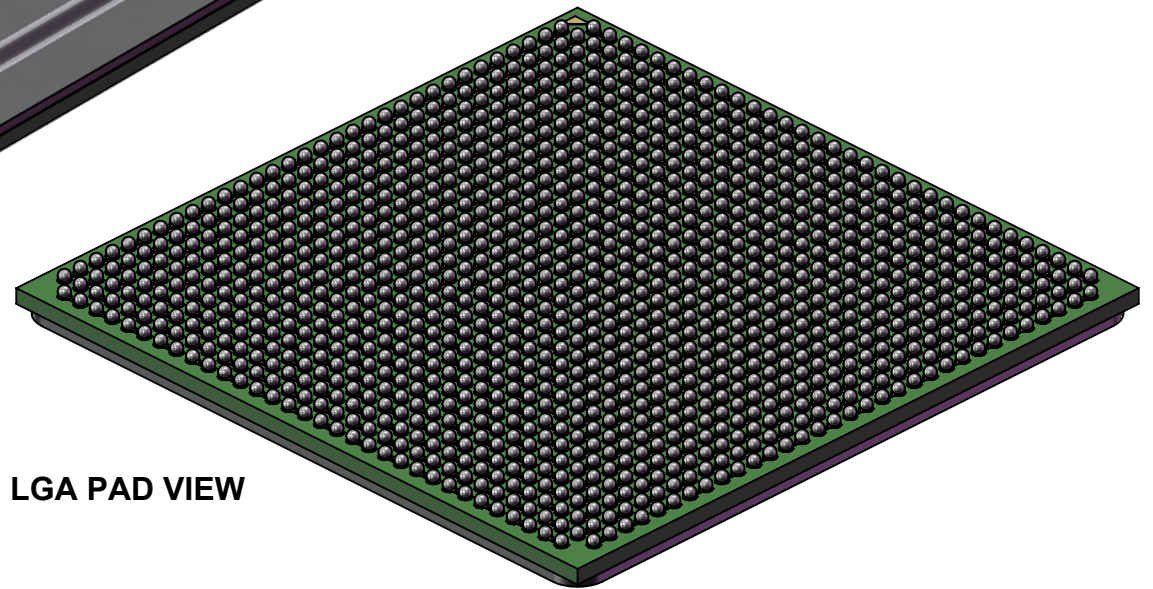

LGA PAD VIEW

TopLine[®]

TITLE SBGA1152T1.0-DC349D
DAISY CHAIN DUMMY

SCALE 3:1	SIZE A	DRAWING NO. 513445	REV B
--------------	-----------	-----------------------	----------

DO NOT SCALE DRAWING

SHEET 8 OF 9

BOTTOM SOLDER MASK (RIGHT READING)

34 33 32 31 30 29 28 27 26 25 24 23 22 21 20 19 18 17 16 15 14 13 12 11 10 9 8 7 6 5 4 3 2 1

A
B
C
D
E
F
G
H
J
K
L
M
N
P
R
T
U
V
W
Y
AA
AB
AC
AD
AE
AF
AG
AH
AJ
AK
AL
AM
AN
AP

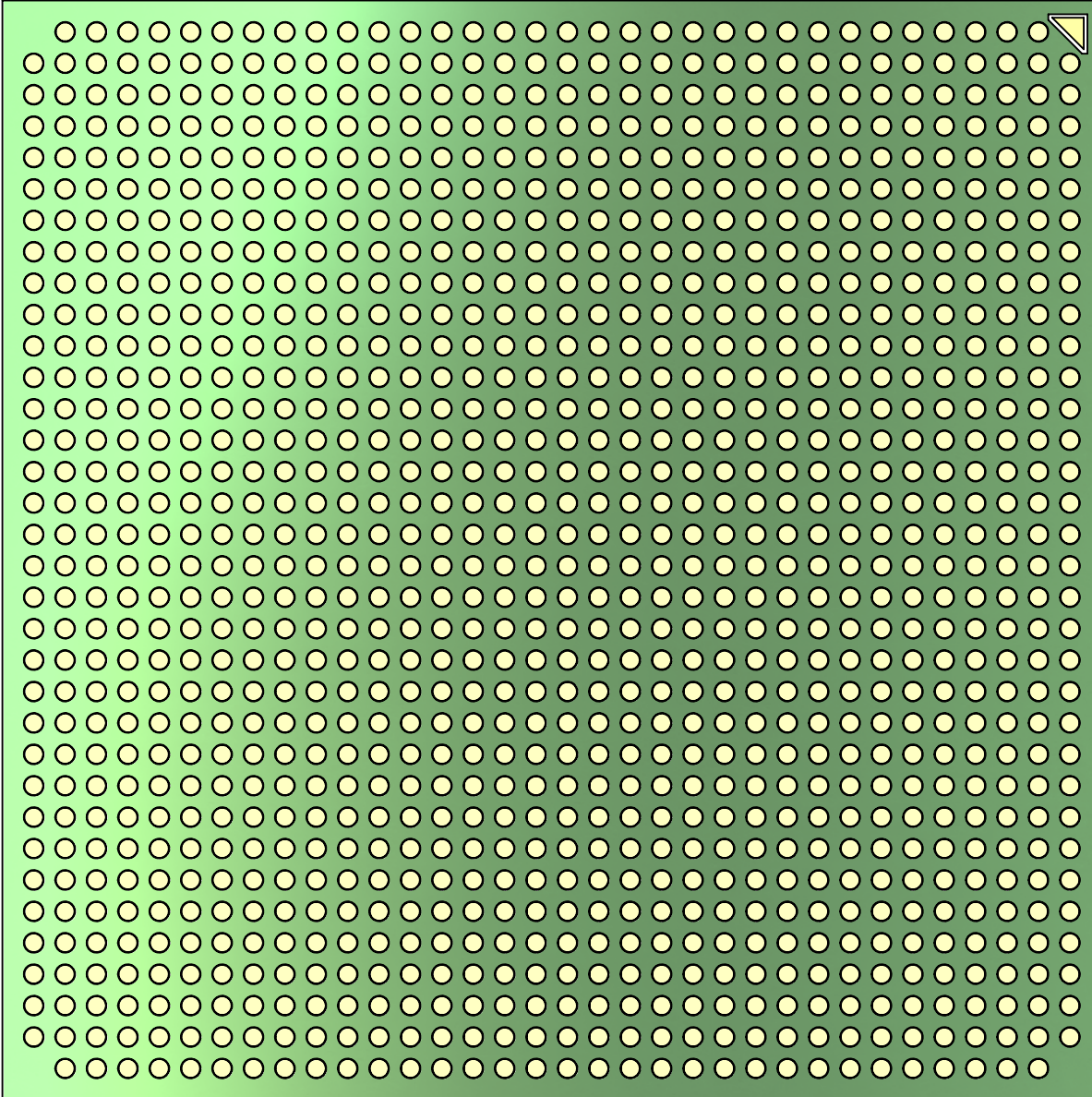

TopLine[®]			
TITLE		SBGA1152T1.0-DC349D DAISY CHAIN DUMMY	
SCALE	SIZE	DRAWING NO.	REV
4.5:1	A	513445	B
DO NOT SCALE DRAWING			SHEET 9 OF 9