

TOP VIEW

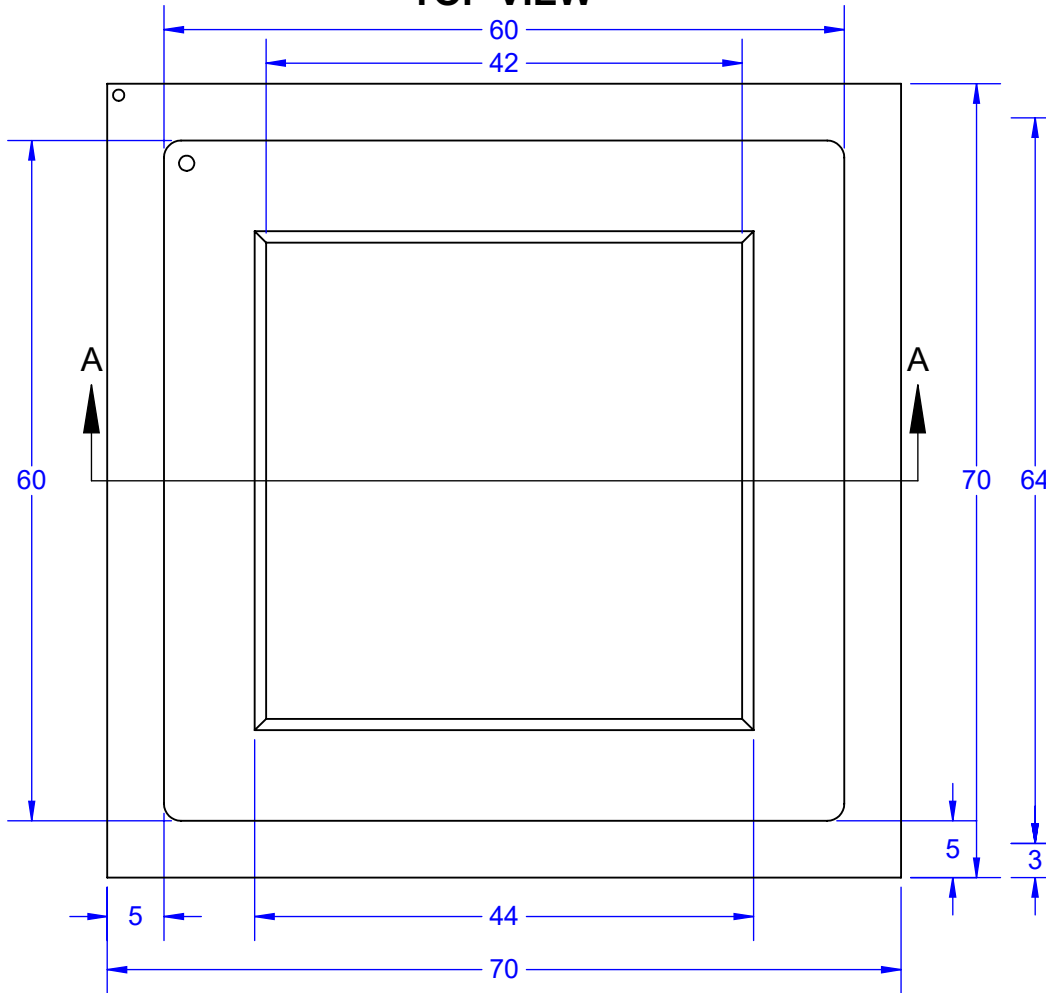

BOTTOM VIEW

64 62 60 58 56 54 52 50 48 46 44 42 40 38 36 34 32 30 28 26 24 22 20 18 16 14 12 10 8 6 4 2
65 63 61 59 57 55 53 51 49 47 45 43 41 39 37 35 33 31 29 27 25 23 21 19 17 15 13 11 9 7 5 3 1

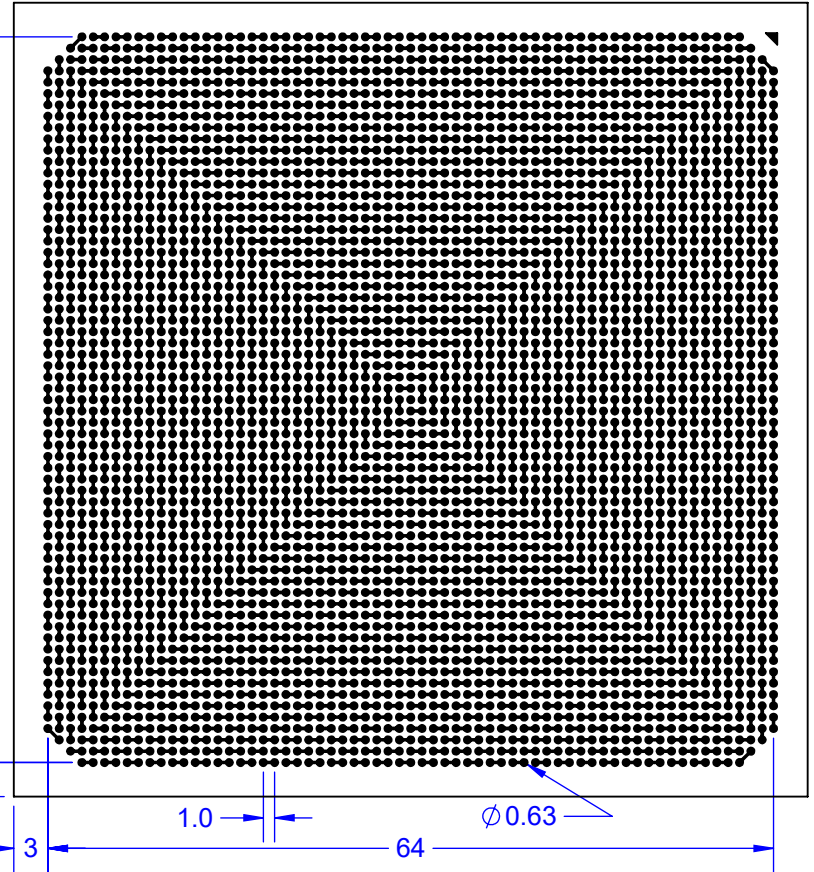

A B
C D
E F
G H
J K
L M
N P
R T
U V
W Y
AA AB
AC AD
AE AF
AG AH
AJ AK
AL AM
AN AP
AR AT
AU AV
AW AY
BA BB
BC BD
BE BF
BG BH
BJ BK
BL BM
BN BP
BR BT
BU BV
BW BY
CA CB
CC CD
CE

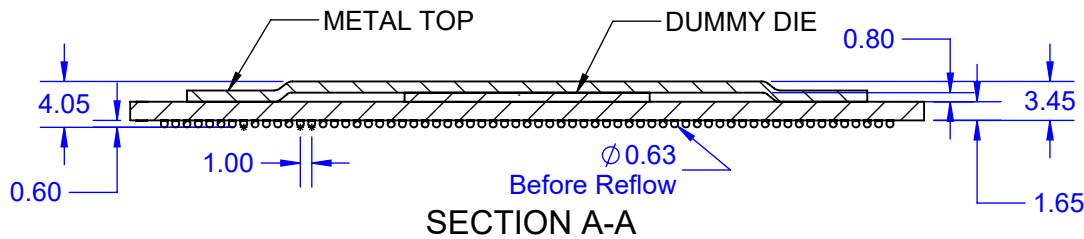

SECTION A-A

Notes: (Unless Otherwise Specified).

- 1) ALL DIMENSIONS ARE IN MM.
- 2) SOLDER BALL ALLOY: SEE PART NUMBER TABLE.
- 3) BALL DIAMETER (BEFORE REFLOW): 0.635mm (25 MIL).
- 4) SOLDER MASK DEFINED PAD OPENING: 0.50mm (19.7 MIL).
- 5) PAD Cu DIAMETER: 0.635mm (25 MIL).
- 6) SUBSTRATE MATERIAL: ORGANIC.
- 7) DUMMY DIE Si (SILICON) 21.6 x 16 x .787mm.
- 8) DAISY CHAIN PATTERN (SEE PAGE 2).
- 9) MSL-3 RECOMMENDED BAKING 24 HOURS @ 125°C TO REMOVE MOISTURE PRIOR SOLDERING TO PC BOARD.

PART NUMBER TABLE

PART NUMBER	BALL ALLOY	BALL ALLOY	RoHS	Si DIE
SBGA4201T1.0C-DC659D	Sn96.5/Ag3.0/Cu0.5	SAC305	YES	YES
SBGA4201T1.0-DC659D	Sn63/Pb37	Sn63	NO	YES

APPROVALS	DATE	TopLine®			
DRAWN T. Au	6/10/2022				
ENG M. Hart	6/10/2022	TITLE SBGA4201T1.0-DC659D DAISY CHAIN DUMMY			
MFG		SCALE	SIZE	DRAWING NO.	REV
QA		3:2	A	516597	A
CUST		DO NOT SCALE DRAWING			SHEET 1 OF 6
REVISED					

BOTTOM SIDE (TOP X-RAY VIEW)

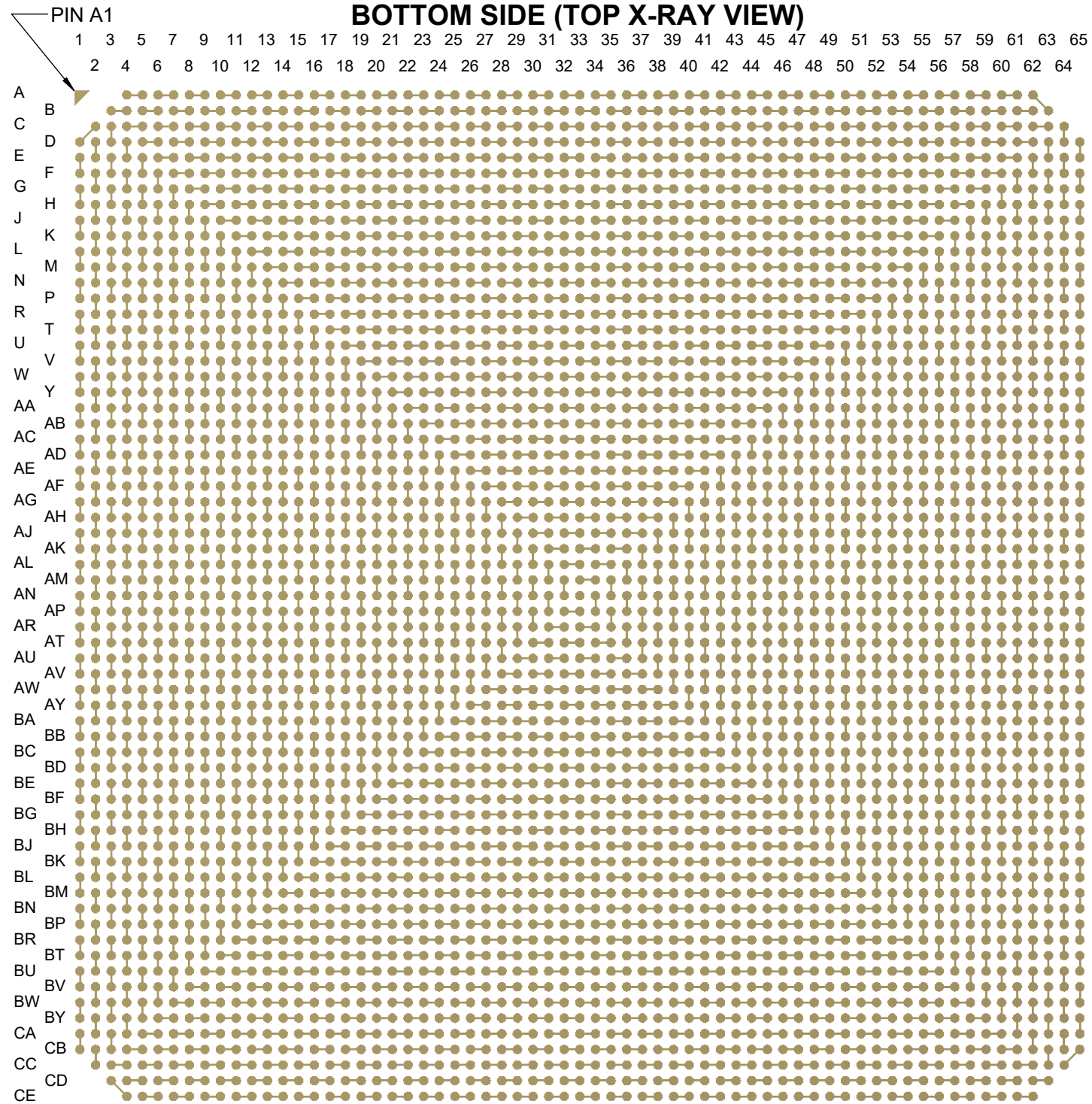

TITLE			
S8GA4201T1.0-DC659D DAISY CHAIN DUMMY			
SCALE	SIZE	DRAWING NO.	REV
2.75:1	A	516597	A
DO NOT SCALE DRAWING			SHEET 3 OF 6

MODEL

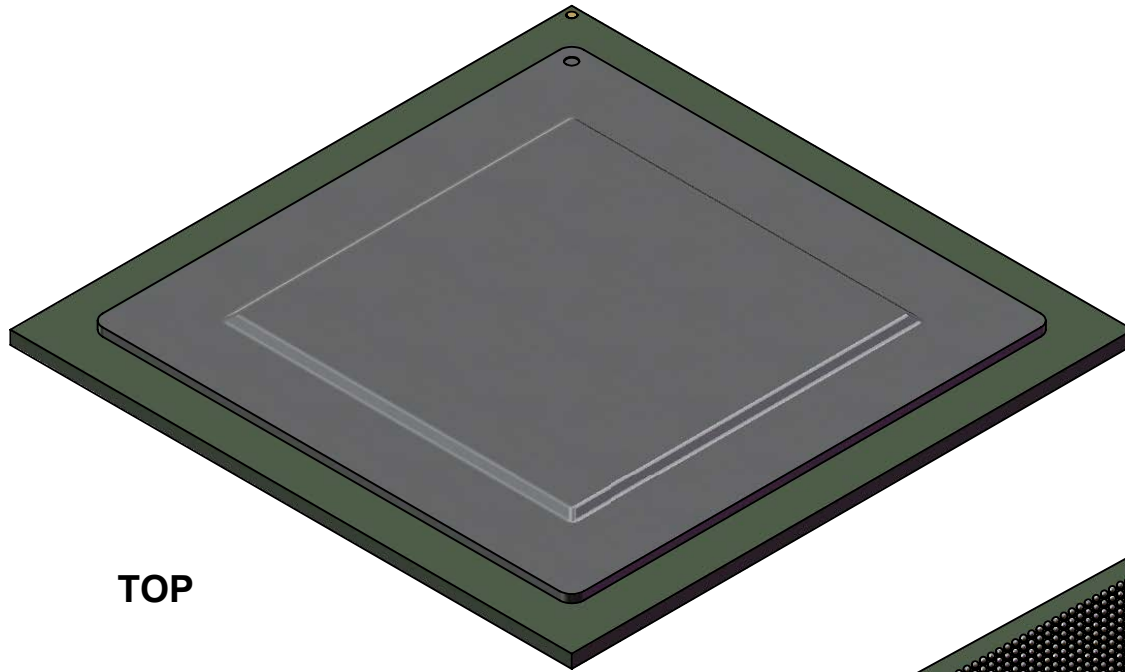

TOP

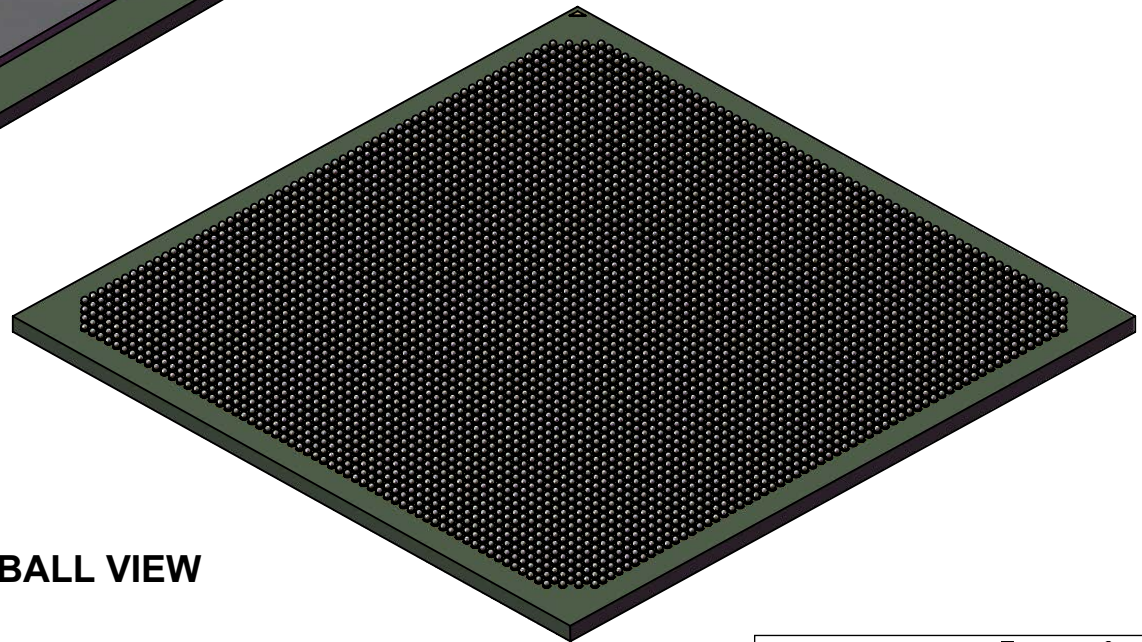

BALL VIEW

TopLine[®]

TITLE SPGA4201T1.0-DC659D
DAISY CHAIN DUMMY

SCALE	SIZE	DRAWING NO.	REV
3:2	A	516597	A

DO NOT SCALE DRAWING

SHEET 5 OF 6

BOTTOM SOLDER MASK (RIGHT READING)

65 63 61 59 57 55 53 51 49 47 45 43 41 39 37 35 33 31 29 27 25 23 21 19 17 15 13 11 9 7 5 3 1
64 62 60 58 56 54 52 50 48 46 44 42 40 38 36 34 32 30 28 26 24 22 20 18 16 14 12 10 8 6 4 2

A
B
C
D
E
F
G
H
J
K
L
M
N
P
R
T
U
V
W
Y
AA
AB
AC
AD
AE
AF
AG
AH
AJ
AK
AL
AM
AN
AP
AR
AT
AU
AV
AW
AY
BA
BB
BC
BD
BE
BF
BG
BH
BJ
BK
BL
BM
BN
BP
BR
BT
BU
BV
BW
BY
CA
CB
CC
CD
CE

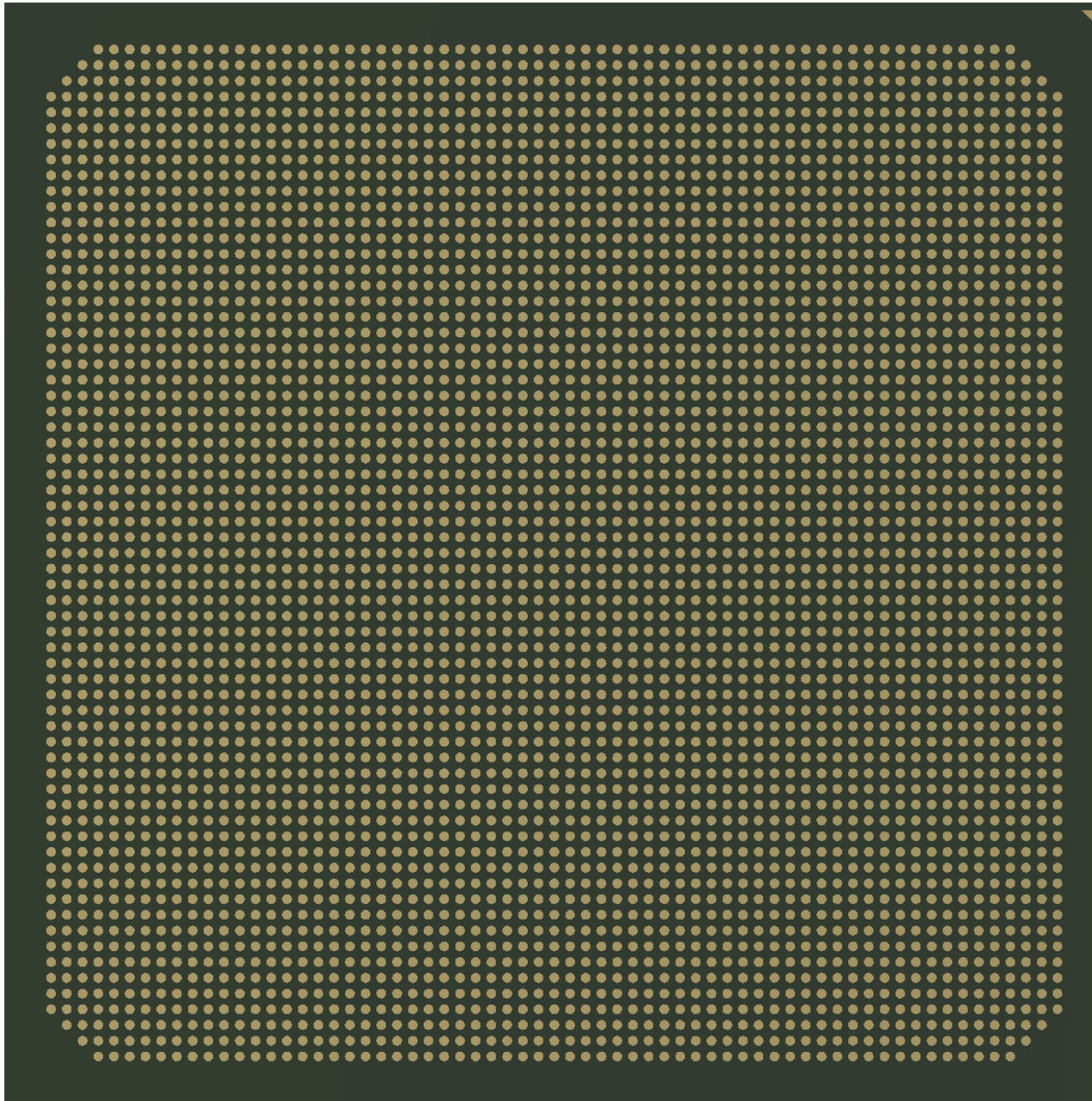

TopLine®			
TITLE		SBA4201T1.0-DC659D DAISY CHAIN DUMMY	
SCALE	SIZE	DRAWING NO.	REV
2.5:1	A	516597	A
DO NOT SCALE DRAWING			SHEET 6 OF 6