

### BOTTOM VIEW

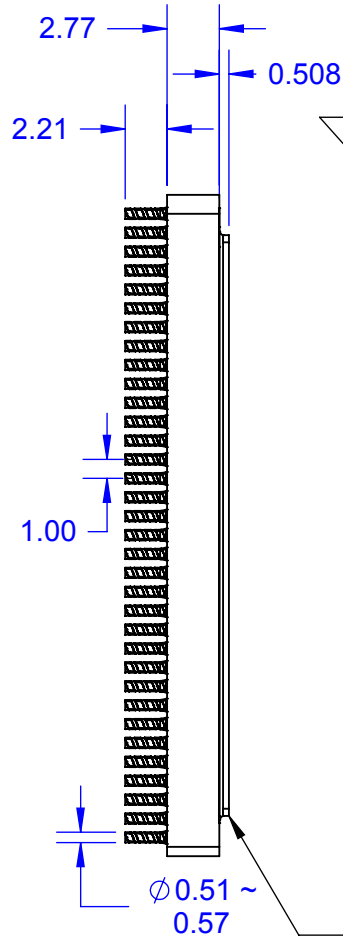

### TOP VIEW

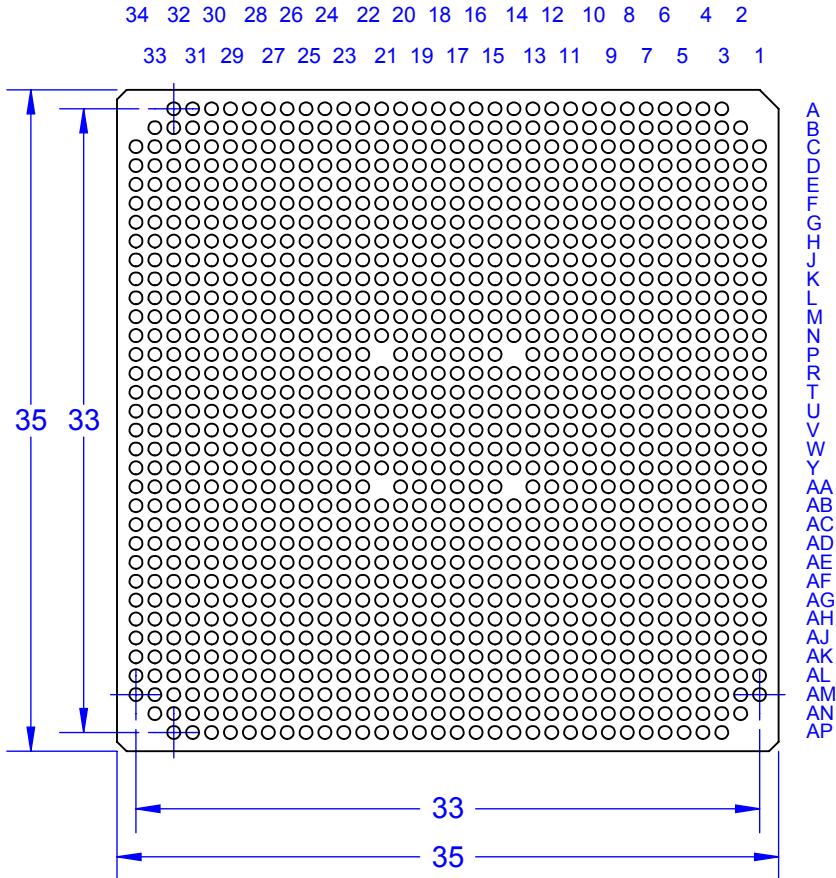
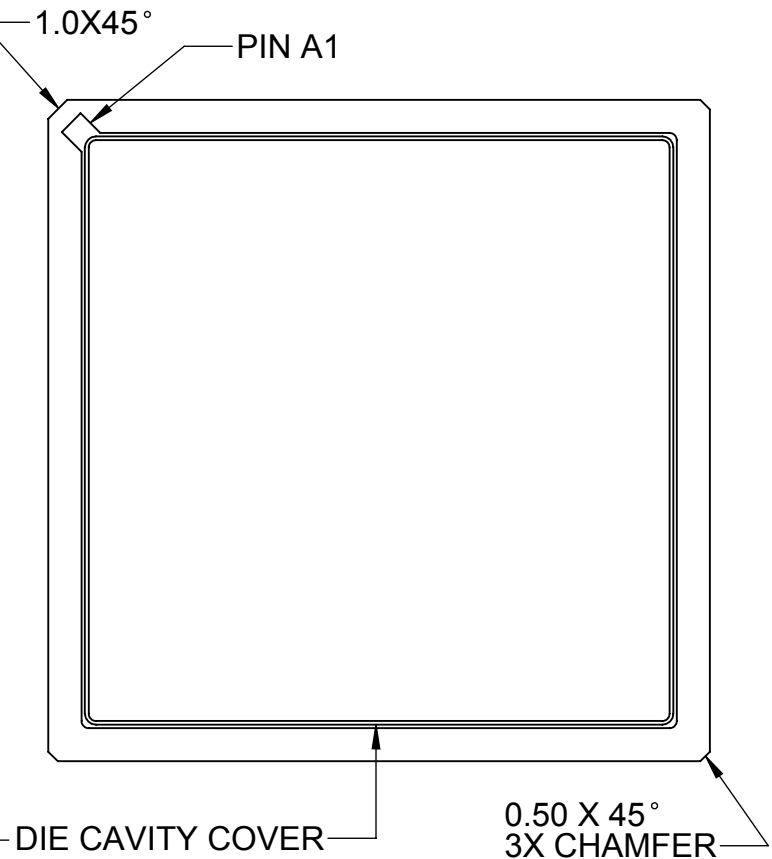

Notes: (Unless Otherwise Specified).

- 1) DIMENSIONS ARE IN mm.
- 2) DEPOPULATED PADS: A2, A33, AA14, AA21, AN1, AN34, AP2, AP33, B1, B34, P14, P21.

#### PART NUMBER OPTIONS

| PART NUMBER          | DUMMY DIE | SOLDER PIN             |
|----------------------|-----------|------------------------|
| CCGA1140T1.0-DC343D  | YES       | Pb80/Sn20<br>Cu RIBBON |
| CCGA1140T1.0A-DC343D | YES       | Pb90/Sn10              |
| CLGA1140T1.0-DC343D  | YES       | NONE                   |

| APPROVALS   | DATE     |  |      |             |              |
|-------------|----------|---|------|-------------|--------------|
| DRAWN T.Au  | 10/06/13 |   |      |             |              |
| ENG M. Hart | 10/06/13 | TITLE CCGA1140T1.0-DC343D<br>DUMMY COLUMN GRID ARRAY                                  |      |             |              |
| MFG         |          | SCALE   | SIZE | DRAWING NO. | REV          |
| QA          |          | 2.5:1   | A    | 160130      | A            |
| CUST        |          | DO NOT SCALE DRAWING  |      |             | SHEET 1 OF 5 |
| REVISED     |          |   |      |             |              |

# DAISY CHAIN PATTERN

## COLUMN (BALL) VIEW

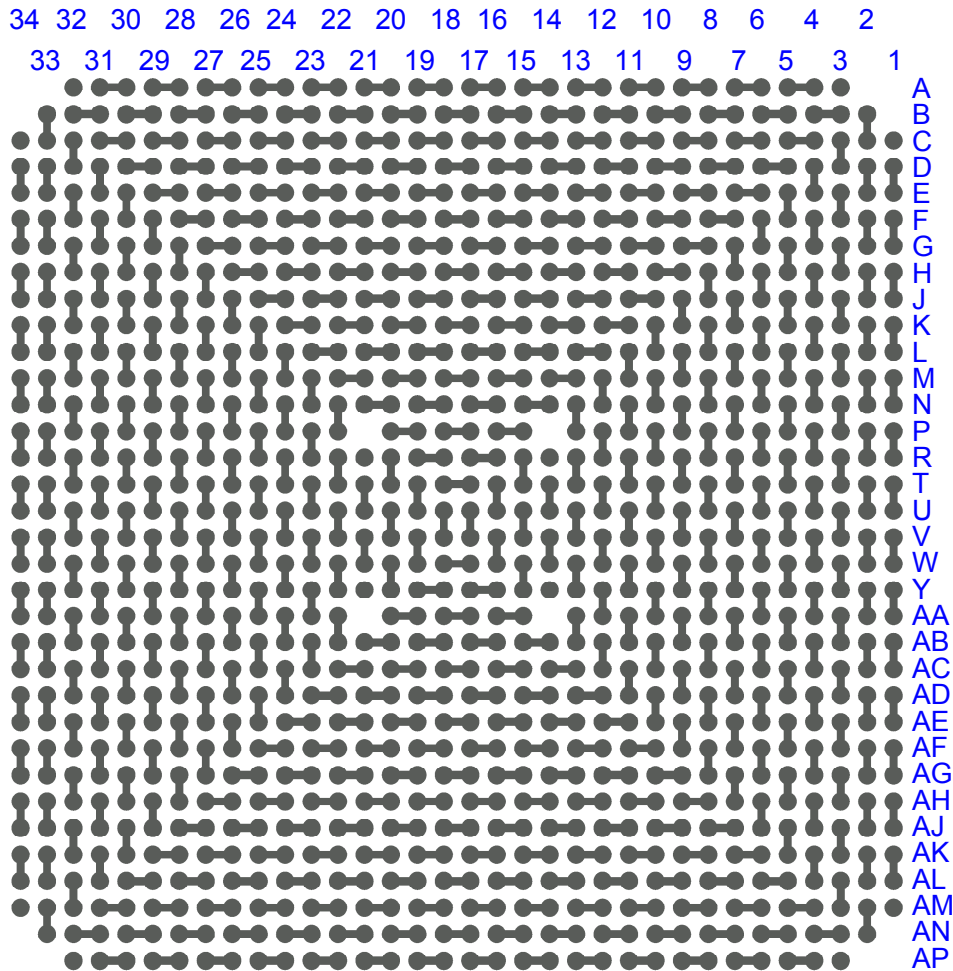

## BOTTOM X-RAY VIEWED FROM TOP

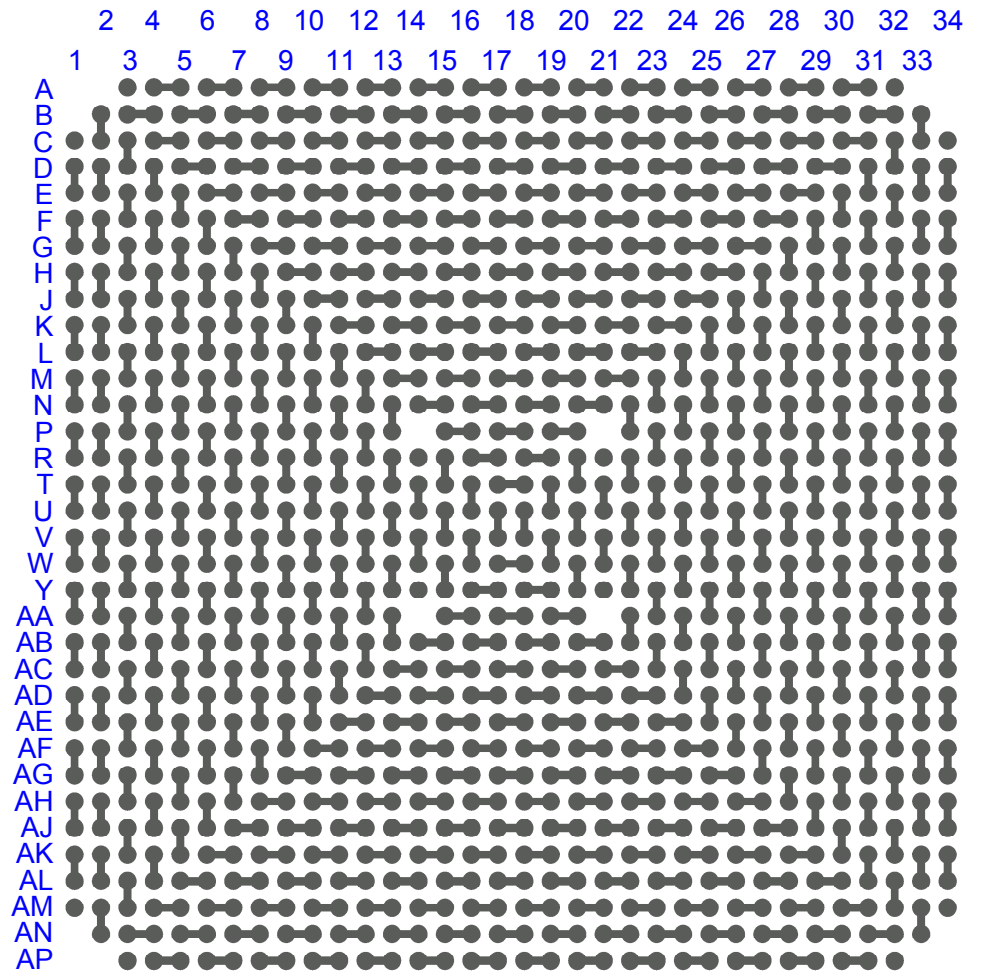

**TopLine®**

TITLE CCGA1140T1.0-DC343D  
DUMMY COLUMN GRID ARRAY

|                 |           |                       |          |
|-----------------|-----------|-----------------------|----------|
| SCALE<br>2.75:1 | SIZE<br>A | DRAWING NO.<br>160130 | REV<br>A |
|-----------------|-----------|-----------------------|----------|

DO NOT SCALE DRAWING

SHEET 2 OF 5

# SOLDER PIN OPTIONS SECTION DETAILS

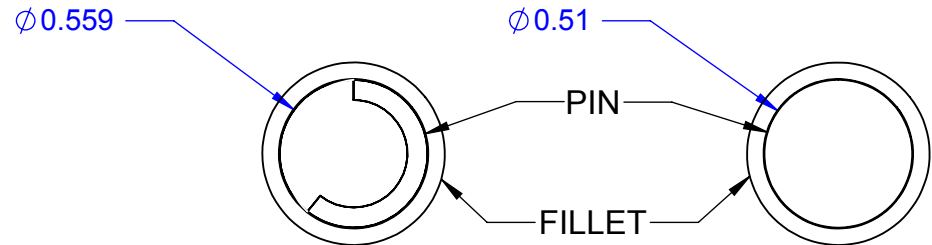
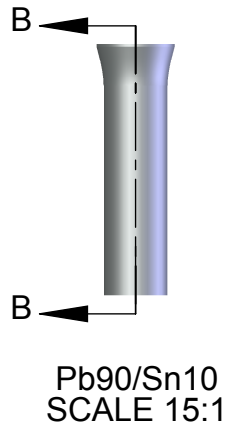
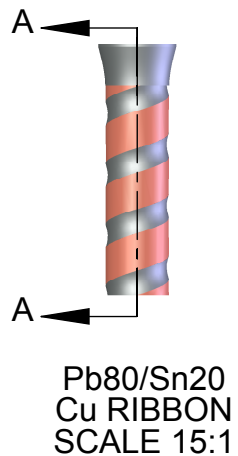
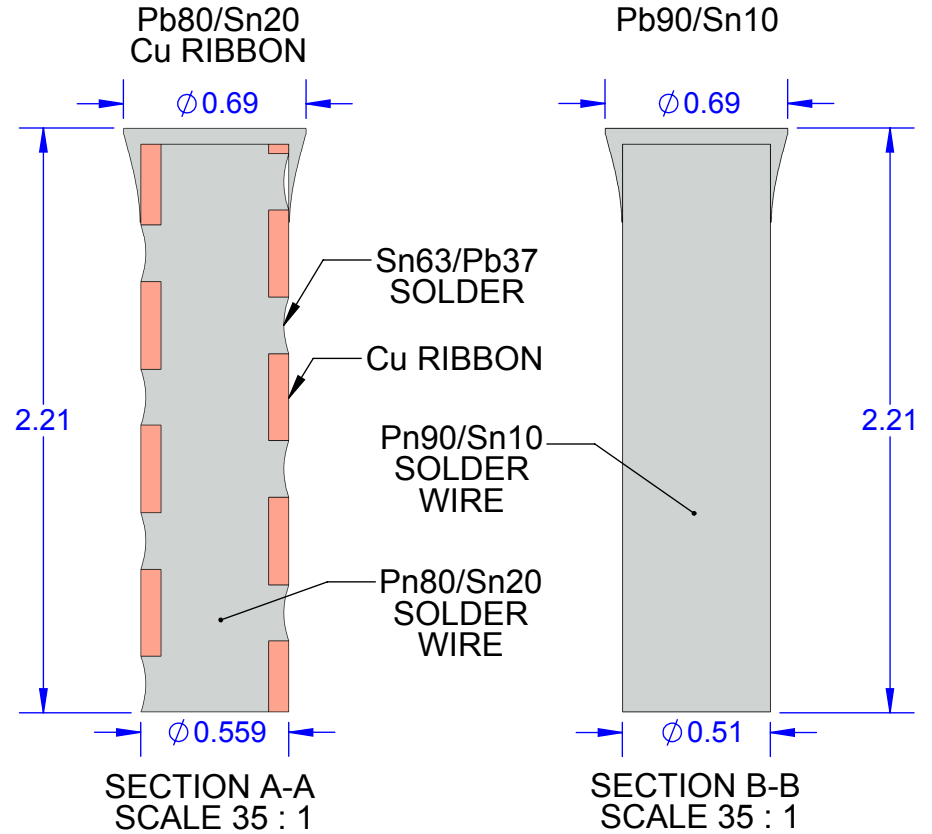
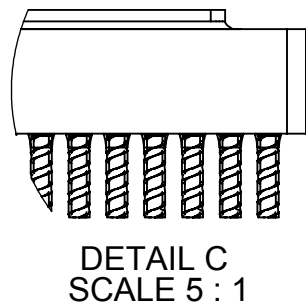
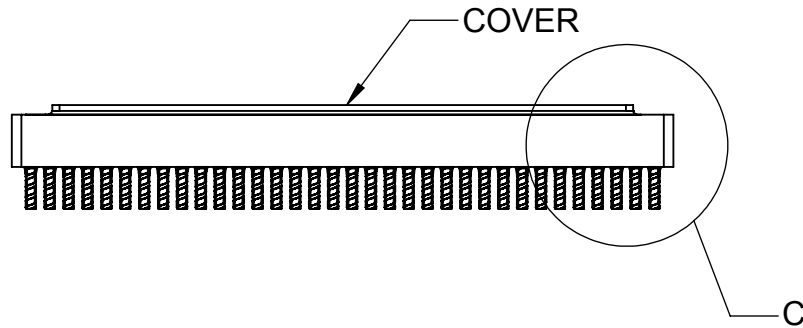

| PART NUMBER OPTIONS  |           |                        |
|----------------------|-----------|------------------------|
| PART NUMBER          | DUMMY DIE | SOLDER PIN             |
| CCGA1140T1.0-DC343D  | YES       | Pb80/Sn20<br>Cu RIBBON |
| CCGA1140T1.0A-DC343D | YES       | Pb90/Sn10              |
| CLGA1140T1.0-DC343D  | YES       | NONE                   |

| TITLE CCGA1140T1.0-DC343D<br>DUMMY COLUMN GRID ARRAY |           |                       |              |
|--|-----------|-----------------------|--------------|
| SCALE<br>2.5:1                                       | SIZE<br>A | DRAWING NO.<br>160130 | REV<br>A     |
| DO NOT SCALE DRAWING                                 |           |                       | SHEET 3 OF 5 |

## NET LIST DAISY CHAIN CONNECTION TABLE (1/2)

function: SIGNAL

| LGA No.    | LGA No.      | LGA No.      | LGA No.      | LGA No.      | LGA No.      | LGA No.      | LGA No.      | LGA No.      | LGA No.      | LGA No.      | LGA No.      | LGA No.      | LGA No.    | LGA No.    | LGA No.    |
|------------|--------------|--------------|--------------|--------------|--------------|--------------|--------------|--------------|--------------|--------------|--------------|--------------|------------|------------|------------|
| —<br>A3    | AA11<br>AB11 | AB18<br>AB19 | AC26<br>AD26 | AD33<br>AE33 | AF6<br>AG6   | AG13<br>AG14 | AH20<br>AH21 | AJ27<br>AJ28 | AK34<br>AL34 | AM8<br>AM9   | AN15<br>AN16 | AP24<br>AP25 | B29<br>B30 | D1<br>E1   | E5<br>F5   |
| A4<br>A5   | AA13<br>AB13 | AB20<br>AB21 | AC28<br>AD28 | AD34<br>AE34 | AF8<br>AG8   | AG15<br>AG16 | AH22<br>AH23 | AJ30<br>AK30 | AL3<br>AM3   | AM10<br>AM11 | AN17<br>AN18 | AP26<br>AP27 | B31<br>B32 | D2<br>E2   | E6<br>E7   |
| A6<br>A7   | AA15<br>AA16 | AB23<br>AC23 | AC30<br>AD30 | AE3<br>AF3   | AF10<br>AF11 | AG17<br>AG18 | AH24<br>AH25 | AJ32<br>AK32 | AL5<br>AL6   | AM12<br>AM13 | AN19<br>AN20 | AP28<br>AP29 | B33<br>C33 | D4<br>E4   | E8<br>E9   |
| A8<br>A9   | AA17<br>AA18 | AB25<br>AC25 | AC32<br>AD32 | AE5<br>AF5   | AF12<br>AF13 | AG19<br>AG20 | AH26<br>AH27 | AK1<br>AL1   | AL7<br>AL8   | AM14<br>AM15 | AN21<br>AN22 | AP30<br>AP31 | —<br>C34   | D5<br>D6   | E10<br>E11 |
| A10<br>A11 | AA19<br>AA20 | AB27<br>AC27 | AD1<br>AE1   | AE7<br>AF7   | AF14<br>AF15 | AG21<br>AG22 | AH29<br>AJ29 | AK2<br>AL2   | AL9<br>AL10  | AM16<br>AM17 | AN23<br>AN24 | AP32<br>—    | C3<br>D3   | D7<br>D8   | E12<br>E13 |
| A12<br>A13 | AA22<br>AB22 | AB29<br>AC29 | AD2<br>AE2   | AE9<br>AF9   | AF16<br>AF17 | AG23<br>AG24 | AH31<br>AJ31 | AK4<br>AL4   | AL11<br>AL12 | AM18<br>AM19 | AN25<br>AN26 | —<br>C1      | C4<br>C5   | D9<br>D10  | E14<br>E15 |
| A14<br>A15 | AA24<br>AB24 | AB31<br>AC31 | AD4<br>AE4   | AE11<br>AE12 | AF18<br>AF19 | AG25<br>AG26 | AH33<br>AJ33 | AK6<br>AK7   | AL13<br>AL14 | AM20<br>AM21 | AN27<br>AN28 | B2<br>C2     | C6<br>C7   | D11<br>D12 | E16<br>E17 |
| A16<br>A17 | AA26<br>AB26 | AB33<br>AC33 | AD6<br>AE6   | AE13<br>AE14 | AF20<br>AF21 | AG28<br>AH28 | AH34<br>AJ34 | AK8<br>AK9   | AL15<br>AL16 | AM22<br>AM23 | AN29<br>AN30 | B3<br>B4     | C8<br>C9   | D13<br>D14 | E18<br>E19 |
| A18<br>A19 | AA28<br>AB28 | AB34<br>AC34 | AD8<br>AE8   | AE15<br>AE16 | AF22<br>AF23 | AG30<br>AH30 | AJ3<br>AK3   | AK10<br>AK11 | AL17<br>AL18 | AM24<br>AM25 | AN31<br>AN32 | B5<br>B6     | C10<br>C11 | D15<br>D16 | E20<br>E21 |
| A20<br>A21 | AA30<br>AB30 | AC3<br>AD3   | AD10<br>AE10 | AE17<br>AE18 | AF24<br>AF25 | AG32<br>AH32 | AJ5<br>AK5   | AK12<br>AK13 | AL19<br>AL20 | AM26<br>AM27 | —<br>AP3     | B7<br>B8     | C12<br>C13 | D17<br>D18 | E22<br>E23 |
| A22<br>A23 | AA32<br>AB32 | AC5<br>AD5   | AD12<br>AD13 | AE19<br>AE20 | AF27<br>AG27 | AH1<br>AJ1   | AJ7<br>AJ8   | AK14<br>AK15 | AL21<br>AL22 | AM28<br>AM29 | AP4<br>AP5   | B9<br>B10    | C14<br>C15 | D19<br>D20 | E24<br>E25 |
| A24<br>A25 | AB1<br>AC1   | AC7<br>AD7   | AD14<br>AD15 | AE21<br>AE22 | AF29<br>AG29 | AH2<br>AJ2   | AJ9<br>AJ10  | AK16<br>AK17 | AL23<br>AL24 | AM30<br>AM31 | AP6<br>AP7   | B11<br>B12   | C16<br>C17 | D21<br>D22 | E26<br>E27 |
| A26<br>A27 | AB2<br>AC2   | AC9<br>AD9   | AD16<br>AD17 | AE23<br>AE24 | AF31<br>AG31 | AH4<br>AJ4   | AJ11<br>AJ12 | AK18<br>AK19 | AL25<br>AL26 | AM33<br>AN33 | AP8<br>AP9   | B13<br>B14   | C18<br>C19 | D23<br>D24 | E28<br>E29 |
| A28<br>A29 | AB4<br>AC4   | AC11<br>AD11 | AD18<br>AD19 | AE26<br>AF26 | AF33<br>AG33 | AH6<br>AJ6   | AJ13<br>AJ14 | AK20<br>AK21 | AL27<br>AL28 | AM34<br>—    | AP10<br>AP11 | B15<br>B16   | C20<br>C21 | D25<br>D26 | E30<br>F30 |
| A30<br>A31 | AB6<br>AC6   | AC13<br>AC14 | AD20<br>AD21 | AE28<br>AF28 | AF34<br>AG34 | AH8<br>AH9   | AJ15<br>AJ16 | AK22<br>AK23 | AL29<br>AL30 | AN3<br>AN4   | AP12<br>AP13 | B17<br>B18   | C22<br>C23 | D27<br>D28 | E32<br>F32 |
| A32<br>—   | AB8<br>AC8   | AC15<br>AC16 | AD22<br>AD23 | AE30<br>AF30 | AG3<br>AH3   | AH10<br>AH11 | AJ17<br>AJ18 | AK24<br>AK25 | AL32<br>AM32 | AN5<br>AN6   | AP14<br>AP15 | B19<br>B20   | C24<br>C25 | D29<br>D30 | F1<br>G1   |
| AA3<br>AB3 | AB10<br>AC10 | AC17<br>AC18 | AD25<br>AE25 | AE32<br>AF32 | AG5<br>AH5   | AH12<br>AH13 | AJ19<br>AJ20 | AK26<br>AK27 | AM1<br>—     | AN7<br>AN8   | AP16<br>AP17 | B21<br>B22   | C26<br>C27 | D31<br>E31 | F2<br>G2   |
| AA5<br>AB5 | AB12<br>AC12 | AC19<br>AC20 | AD27<br>AE27 | AF1<br>AG1   | AG7<br>AH7   | AH14<br>AH15 | AJ21<br>AJ22 | AK28<br>AK29 | AM2<br>AN2   | AN9<br>AN10  | AP18<br>AP19 | B23<br>B24   | C28<br>C29 | D33<br>E33 | F4<br>G4   |
| AA7<br>AB7 | AB14<br>AC15 | AC21<br>AC22 | AD29<br>AE29 | AF2<br>AG2   | AG9<br>AG10  | AH16<br>AH17 | AJ23<br>AJ24 | AK31<br>AL31 | AM4<br>AM5   | AN11<br>AN12 | AP20<br>AP21 | B25<br>B26   | C30<br>C31 | D34<br>E34 | F6<br>G6   |
| AA9<br>AB9 | AB16<br>AB17 | AC24<br>AD24 | AD31<br>AE31 | AF4<br>AG4   | AG11<br>AG12 | AH18<br>AH19 | AJ25<br>AJ26 | AK33<br>AL33 | AM6<br>AM7   | AN13<br>AN14 | AP22<br>AP23 | B27<br>B28   | C32<br>D32 | E3<br>F3   | F7<br>F8   |

NET LIST CONTINUED NEXT PAGE

DEPOPULATED PADS: A2, A33, AA14, AA21, AN1, AN34, AP2, AP33, B1, B34, P14, P21.

**TopLine®**

TITLE CCGA1140T1.0-DC343D  
DUMMY COLUMN GRID ARRAY

|               |           |                       |          |
|---------------|-----------|-----------------------|----------|
| SCALE<br>NONE | SIZE<br>A | DRAWING NO.<br>160130 | REV<br>A |
|---------------|-----------|-----------------------|----------|

DO NOT SCALE DRAWING

SHEET 4 OF 5

## NET LIST DAISY CHAIN CONNECTION TABLE (2/2)

function: SIGNAL

| LGA No. | LGA No. | LGA No. | LGA No. | LGA No. | LGA No. | LGA No. | LGA No. | LGA No. | LGA No. | LGA No. | LGA No. | LGA No. | LGA No. |
|---------|---------|---------|---------|---------|---------|---------|---------|---------|---------|---------|---------|---------|---------|
| F9      | G14     | H19     | J24     | K29     | M1      | N5      | P10     | R15     | T19     | U24     | V31     | Y4      |         |
| F10     | G15     | H20     | J25     | L29     | N1      | P5      | R10     | T15     | U19     | V24     | W31     | AA4     |         |
| F11     | G16     | H21     | J26     | K31     | M2      | N7      | P12     | R16     | T21     | U26     | V33     | Y6      |         |
| F12     | G17     | H22     | K26     | L31     | N2      | P7      | R12     | R17     | U21     | V26     | W33     | AA6     |         |
| F13     | G18     | H23     | J28     | K33     | M4      | N9      | —       | R18     | T23     | U28     | V34     | Y8      |         |
| F14     | G19     | H24     | K28     | L33     | N4      | P9      | R14     | R19     | U23     | V28     | W34     | AA8     |         |
| F15     | G20     | H25     | J30     | K34     | M6      | N11     | P15     | R20     | T25     | U30     | W3      | Y10     |         |
| F16     | G21     | H26     | K30     | L34     | N6      | P11     | P16     | T20     | U25     | V30     | Y3      | AA10    |         |
| F17     | G22     | H27     | J32     | L3      | M8      | N13     | P17     | R22     | T27     | U32     | W5      | Y12     |         |
| F18     | G23     | J27     | K32     | M3      | N8      | P13     | P18     | T22     | U27     | V32     | Y5      | AA12    |         |
| F19     | G24     | H29     | K1      | L5      | M10     | N14     | P19     | R24     | T29     | V1      | W7      | Y14     |         |
| F20     | G25     | J29     | L1      | M5      | N10     | N15     | P20     | T24     | U29     | W1      | Y7      | —       |         |
| F21     | G26     | H31     | K2      | L7      | M12     | N16     | —       | R26     | T31     | V2      | W9      | Y16     |         |
| F22     | G27     | J31     | L2      | M7      | N12     | N17     | R21     | T26     | U31     | W2      | Y9      | Y17     |         |
| F23     | G28     | H33     | K4      | L9      | M13     | N18     | P23     | R28     | T33     | V4      | W11     | Y18     |         |
| F24     | H28     | J33     | L4      | M9      | M14     | N19     | R23     | T28     | U33     | W4      | Y11     | Y19     |         |
| F25     | G30     | H34     | K6      | L11     | M15     | N20     | P25     | R30     | T34     | V6      | W13     | Y21     |         |
| F26     | H30     | J34     | L6      | M11     | M16     | N21     | R25     | T30     | U34     | W6      | Y13     | —       |         |
| F27     | G32     | J3      | K8      | L12     | M17     | N22     | P27     | R32     | U3      | V8      | W15     | Y23     |         |
| F28     | H32     | K3      | L8      | L13     | M18     | P22     | R27     | T32     | V3      | W8      | Y15     | AA23    |         |
| F29     | H1      | J5      | K10     | L14     | M19     | N24     | P29     | T1      | U5      | V10     | W17     | Y25     |         |
| G29     | J1      | K5      | L10     | L15     | M20     | P24     | R29     | U1      | V5      | W10     | W18     | AA25    |         |
| F31     | H2      | J7      | K11     | L16     | M21     | N26     | P31     | T2      | U7      | V12     | W20     | Y27     |         |
| G31     | J2      | K7      | K12     | L17     | M22     | P26     | R31     | U2      | V7      | W12     | Y20     | AA27    |         |
| F33     | H4      | J9      | K13     | L18     | M23     | N28     | P33     | T4      | U9      | V14     | W22     | Y29     |         |
| G33     | J4      | K9      | K14     | L19     | N23     | P28     | R33     | U4      | V9      | W14     | Y22     | AA29    |         |
| F34     | H6      | J10     | K15     | L20     | M25     | N30     | P34     | T6      | U11     | V16     | W24     | Y31     |         |
| G34     | J6      | J11     | K16     | L21     | N25     | P30     | R34     | U6      | V11     | W16     | Y24     | AA31    |         |
| G3      | H8      | J12     | K17     | L22     | M27     | N32     | R3      | T8      | U13     | V19     | W26     | Y33     |         |
| H3      | J8      | J13     | K18     | L23     | M27     | P32     | T3      | U8      | V13     | W19     | Y26     | AA33    |         |
| G5      | H9      | J14     | K19     | L24     | M29     | P1      | R5      | T10     | U15     | V21     | W28     | Y34     |         |
| H5      | H10     | J15     | K20     | M24     | N29     | R1      | T5      | U10     | V15     | W21     | Y28     | AA34    |         |
| G7      | H11     | J16     | K21     | L26     | M31     | P2      | R7      | T12     | U17     | V23     | W30     |         |         |
| H7      | H12     | J17     | K22     | M26     | N31     | R2      | T7      | U12     | V17     | W23     | Y30     |         |         |
| G8      | H13     | J18     | K23     | L28     | M33     | P4      | R9      | T14     | U18     | V25     | W32     | S/R     | NC      |
| G9      | H14     | J19     | K24     | M28     | N33     | R4      | T9      | U14     | V18     | W25     | Y32     |         |         |
| G10     | H15     | J20     | K25     | L30     | M34     | P6      | R11     | T16     | U20     | V27     | Y1      | D/A     | NC      |
| G11     | H16     | J21     | L25     | M30     | N34     | R6      | T11     | U16     | V20     | W27     | AA1     |         |         |
| G12     | H17     | J22     | K27     | L32     | N3      | P8      | R13     | T17     | U22     | V29     | Y2      |         |         |
| G13     | H18     | J23     | L27     | M32     | P3      | R8      | T13     | T18     | V22     | W29     | AA2     |         |         |

DEPOPULATED PADS: A2, A33, AA14, AA21, AN1, AN34, AP2, AP33, B1, B34, P14, P21.



TITLE CCGA1140T1.0-DC343D  
DUMMY COLUMN GRID ARRAY

|               |           |                       |          |
|---------------|-----------|-----------------------|----------|
| SCALE<br>NONE | SIZE<br>A | DRAWING NO.<br>160130 | REV<br>A |
|---------------|-----------|-----------------------|----------|

DO NOT SCALE DRAWING

SHEET 5 OF 5