

### BOTTOM VIEW

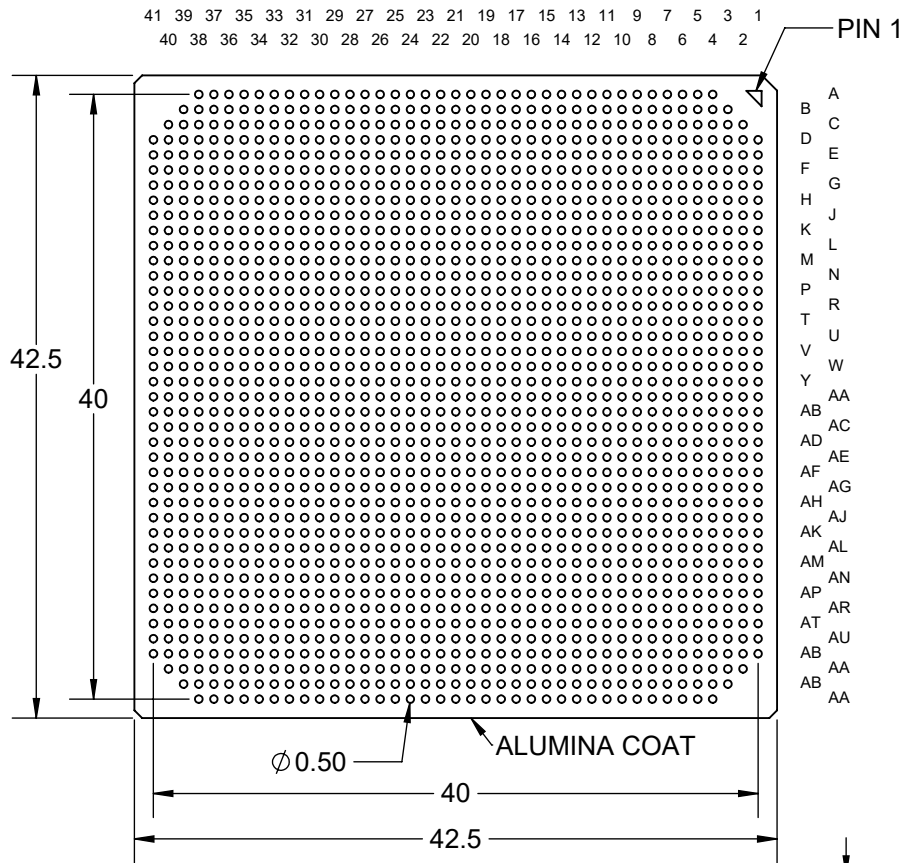

### SIDE VIEW

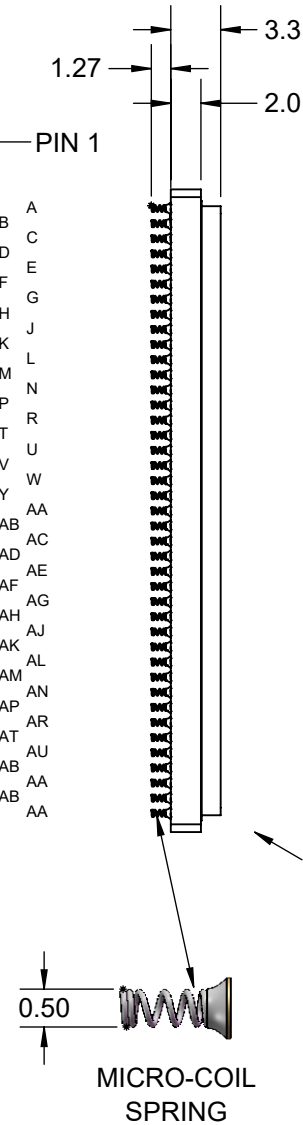

### TOP VIEW

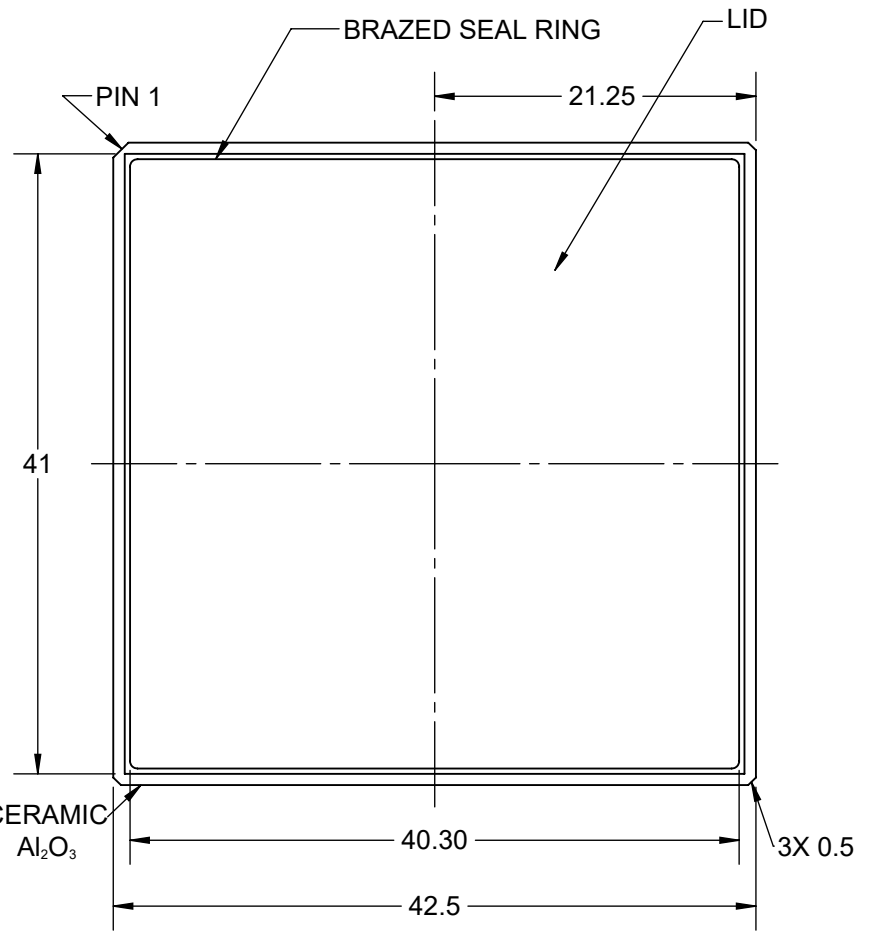

#### NOTES:

1. PLATING TOP AND BOTTOM  
ELECTROLESS Ni 3.2~8.89 $\mu$ m (125~350 micro-inch).  
ELECTROLESS Au 0.25 $\mu$ m (10 micro-inch) MAX

Notes: (Unless Otherwise Specified).

- 1) DIMENSIONS ARE IN mm.
- 2) CCGA SHOWN WITH MICRO-COIL SPRINGS.
- 3) SHOWN WITH LID.
- 4) SHOWN WITH DUMMY DIE.
- 5) PART NUMBER CCGA1657T1.0M-DC416D.

#### PART NUMBER OPTIONS

| PART NUMBER          | DUMMY DIE | SOLDER PIN | LID |
|----------------------|-----------|------------|-----|
| CCGA1657T1.0M-DC416D | YES       | YES        | YES |

**TopLine**<sup>®</sup>

TITLE CCGA1657T1.0-DC416D  
DUMMY COLUMN GRID ARRAY

|              |           |                       |          |
|--------------|-----------|-----------------------|----------|
| SCALE<br>2:1 | SIZE<br>A | DRAWING NO.<br>160193 | REV<br>A |
|--------------|-----------|-----------------------|----------|

DO NOT SCALE DRAWING

SHEET 1 OF 7

# DAISY CHAIN PATTERN

## COLUMN (BALL) VIEW

41 39 37 35 33 31 29 27 25 23 21 19 17 15 13 11 9 7 5 3 1  
40 38 36 34 32 30 28 26 24 22 20 18 16 14 12 10 8 6 4 2

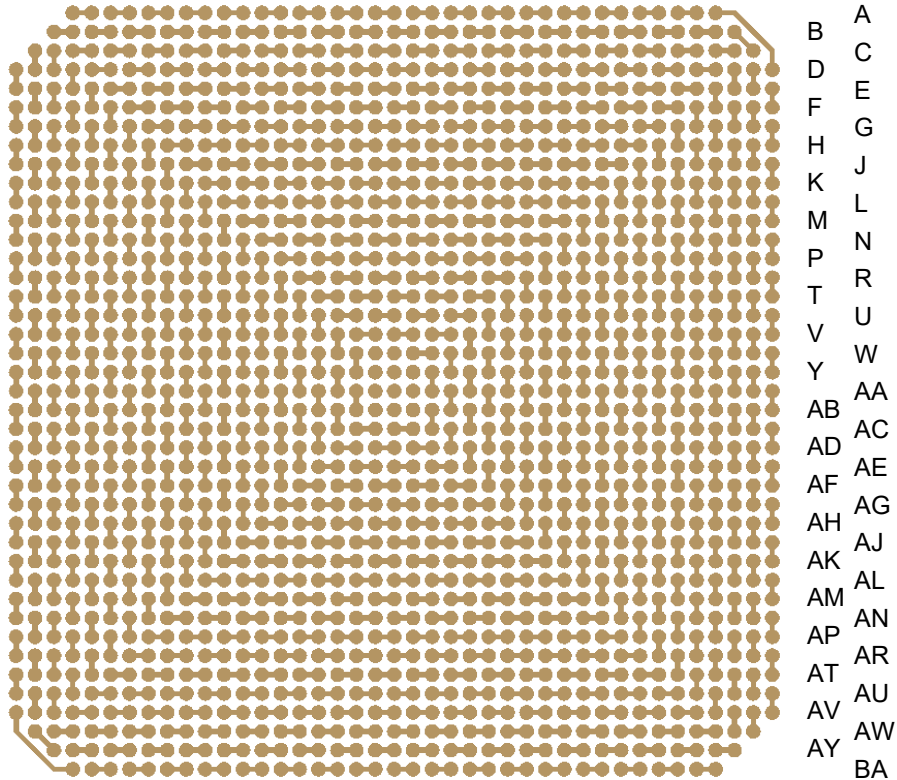

## BOTTOM X-RAY VIEWED FROM TOP

1 3 5 7 9 11 13 15 17 19 21 23 25 27 29 31 33 35 37 39 41  
2 4 6 8 10 12 14 16 18 20 22 24 26 28 30 32 34 36 38 40

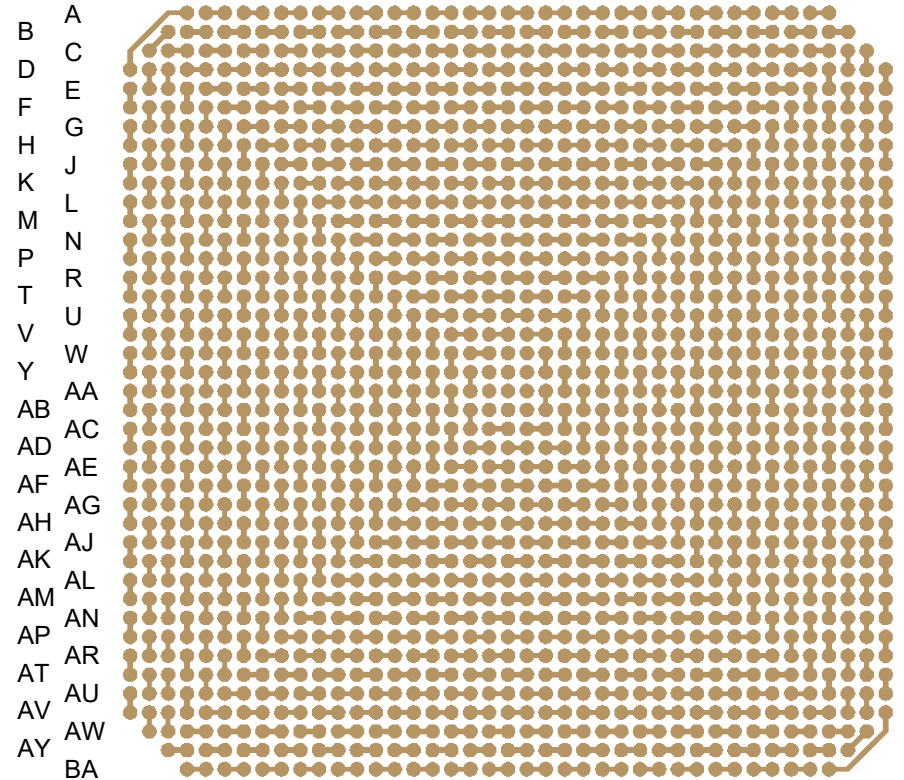

**TopLine®**

TITLE CCGA1657T1.0-DC416D  
DUMMY COLUMN GRID ARRAY

|                |           |                       |          |
|----------------|-----------|-----------------------|----------|
| SCALE<br>2.5:1 | SIZE<br>A | DRAWING NO.<br>160193 | REV<br>A |
|----------------|-----------|-----------------------|----------|

DO NOT SCALE DRAWING

SHEET 2 OF 7

# NET LIST DAISY CHAIN CONNECTION TABLE

| DC PAIR |     |
|---------|-----|
| A4      | D1  |
| A5      | A6  |
| A7      | A8  |
| A9      | A10 |
| A11     | A12 |
| A13     | A14 |
| A15     | A16 |
| A17     | A18 |
| A19     | A20 |
| A21     | A22 |
| A23     | A24 |
| A25     | A26 |
| A27     | A28 |
| A29     | A30 |
| A31     | A32 |
| A33     | A34 |
| A35     | A36 |
| A37     | A38 |
| B3      | C2  |
| B4      | B5  |
| B6      | B7  |
| B8      | B9  |
| B10     | B11 |
| B12     | B13 |
| B14     | B15 |
| B16     | B17 |
| B18     | B19 |
| B20     | B21 |
| B22     | B23 |
| B24     | B25 |
| B26     | B27 |
| B28     | B29 |
| B30     | B31 |
| B32     | B33 |
| B34     | B35 |
| B36     | B37 |

| DC PAIR |     |
|---------|-----|
| C3      | C4  |
| C5      | C6  |
| C7      | C8  |
| C9      | C10 |
| C11     | C12 |
| C13     | C14 |
| C15     | C16 |
| C17     | C18 |
| C19     | C20 |
| C21     | C22 |
| C23     | C24 |
| C25     | C26 |
| C27     | C28 |
| C29     | C30 |
| C31     | C32 |
| C33     | C34 |
| C35     | C36 |
| C37     | C38 |
| C39     | D39 |
| C40     | D40 |
| D2      | E2  |
| D3      | E3  |
| D4      | D5  |
| D6      | D7  |
| D8      | D9  |
| D10     | D11 |
| D12     | D13 |
| D14     | D15 |
| D16     | D17 |
| D18     | D19 |
| D20     | D21 |
| D22     | D23 |
| D24     | D25 |
| D26     | D27 |
| D28     | D29 |
| D30     | D31 |
| D32     | D33 |
| D34     | D35 |
| D36     | D37 |
| D38     | E38 |
| D41     | E41 |

| DC PAIR |     |
|---------|-----|
| E1      | F1  |
| E4      | F4  |
| E5      | E6  |
| E7      | E8  |
| E9      | E10 |
| E11     | E12 |
| E13     | E14 |
| E15     | E16 |
| E17     | E18 |
| E19     | E20 |
| E21     | E22 |
| E23     | E24 |
| E25     | E26 |
| E27     | E28 |
| E29     | E30 |
| E31     | E32 |
| E33     | E34 |
| E35     | E36 |
| E37     | F37 |
| E39     | F39 |
| E40     | F40 |
| F2      | G2  |
| F3      | G3  |
| F5      | G5  |
| F6      | F7  |
| F8      | F9  |
| F10     | F11 |
| F12     | F13 |
| F14     | F15 |
| F16     | F17 |
| F18     | F19 |
| F20     | F21 |
| F22     | F23 |
| F24     | F25 |
| F26     | F27 |
| F28     | F29 |
| F30     | F31 |
| F32     | F33 |
| F34     | F35 |
| F36     | G36 |
| F38     | G38 |
| F41     | G41 |

| DC PAIR |     |
|---------|-----|
| G1      | H1  |
| G4      | H4  |
| G6      | H6  |
| G7      | G8  |
| G9      | G10 |
| G11     | G12 |
| G13     | G14 |
| G15     | G16 |
| G17     | G18 |
| G19     | G20 |
| G21     | G22 |
| G23     | G24 |
| G25     | G26 |
| G27     | G28 |
| G29     | G30 |
| G31     | G32 |
| G33     | G34 |
| G35     | H35 |
| G37     | H37 |
| G39     | H39 |
| G40     | H40 |
| H2      | J2  |
| H3      | J3  |
| H5      | J5  |
| H7      | J7  |
| H8      | H9  |
| H10     | H11 |
| H12     | H13 |
| H14     | H15 |
| H16     | H17 |
| H18     | H19 |
| H20     | H21 |
| H22     | H23 |
| H24     | H25 |
| H26     | H27 |
| H28     | H29 |
| H30     | H31 |
| H32     | H33 |
| H34     | J34 |
| H36     | J36 |
| H38     | J38 |
| H41     | J41 |

| DC PAIR |     |
|---------|-----|
| J1      | K1  |
| J4      | K4  |
| J6      | K6  |
| J8      | K8  |
| J9      | J10 |
| J11     | J12 |
| J13     | J14 |
| J15     | J16 |
| J17     | J18 |
| J19     | J20 |
| J21     | J22 |
| J23     | J24 |
| J25     | J26 |
| J27     | J28 |
| J29     | J30 |
| J31     | J32 |
| J33     | K33 |
| J35     | K35 |
| J37     | K37 |
| J39     | K39 |
| J40     | K40 |
| K2      | L2  |
| K3      | L3  |
| K5      | L5  |
| K7      | L7  |
| K9      | L9  |
| K10     | K11 |
| K12     | K13 |
| K14     | K15 |
| K16     | K17 |
| K18     | K19 |
| K20     | K21 |
| K22     | K23 |
| K24     | K25 |
| K26     | K27 |
| K28     | K29 |
| K30     | K31 |
| K32     | L32 |
| K34     | L34 |
| K36     | L36 |
| K38     | L38 |
| K41     | L41 |

| DC PAIR |     |
|---------|-----|
| L1      | M1  |
| L4      | M4  |
| L6      | M6  |
| L8      | M8  |
| L10     | M10 |
| L11     | L12 |
| L13     | L14 |
| L15     | L16 |
| L17     | L18 |
| L19     | L20 |
| L21     | L22 |
| L23     | L24 |
| L25     | L26 |
| L27     | L28 |
| L29     | L30 |
| L31     | M31 |
| L33     | M33 |
| L35     | M35 |
| L37     | M37 |
| L39     | M39 |
| L40     | M40 |
| M2      | N2  |
| M3      | N3  |
| M5      | N5  |
| M7      | N7  |
| M9      | N9  |
| M11     | N11 |
| M12     | M13 |
| M14     | M15 |
| M16     | M17 |
| M18     | M19 |
| M20     | M21 |
| M22     | M23 |
| M24     | M25 |
| M26     | M27 |
| M28     | M29 |
| M30     | N30 |
| M32     | N32 |
| M34     | N34 |
| M36     | N36 |
| M38     | N38 |
| M41     | N41 |

| DC PAIR |     |
|---------|-----|
| N1      | P1  |
| N4      | P4  |
| N6      | P6  |
| N8      | P8  |
| N10     | P10 |
| N12     | P12 |
| N13     | N14 |
| N15     | N16 |
| N17     | N18 |
| N19     | N20 |
| N21     | N22 |
| N23     | N24 |
| N25     | N26 |
| N27     | N28 |
| N29     | P29 |
| N31     | P31 |
| N33     | P33 |
| N35     | P35 |
| N37     | P37 |
| N39     | P39 |
| N40     | P40 |
| P2      | R2  |
| P3      | R3  |
| P5      | R5  |
| P7      | R7  |
| P9      | R9  |
| P11     | R11 |
| P13     | R13 |
| P14     | P15 |
| P16     | P17 |
| P18     | P19 |
| P20     | P21 |
| P22     | P23 |
| P24     | P25 |
| P26     | P27 |
| P28     | R28 |
| P30     | R30 |
| P32     | R32 |
| P34     | R34 |
| P36     | R36 |
| P38     | R38 |
| P41     | R41 |

CONTINUED NEXT PAGE

|  |           |                       |              |
|--|-----------|-----------------------|--------------|
| <b>TopLine®</b>                                      |           |                       |              |
| TITLE CCGA1657T1.0-DC416D<br>DUMMY COLUMN GRID ARRAY |           |                       |              |
| SCALE<br>NONE  | SIZE<br>A | DRAWING NO.<br>160193 | REV<br>A     |
| DO NOT SCALE DRAWING                                 |           |                       | SHEET 3 OF 7 |

# NET LIST DAISY CHAIN CONNECTION TABLE

| DC PAIR |     | DC PAIR |     | DC PAIR |      | DC PAIR |      | DC PAIR |      | DC PAIR |      | DC PAIR |      |
|---------|-----|---------|-----|---------|------|---------|------|---------|------|---------|------|---------|------|
| R1      | T1  | U1      | V1  | W1      | Y1   | Y38     | AA38 | AB34    | AC34 | AD38    | AE38 | AG1     | AH1  |
| R4      | T4  | U4      | V4  | W4      | Y4   | Y41     | AA41 | AB36    | AC36 | AD41    | AE41 | AG4     | AH4  |
| R6      | T6  | U6      | V6  | W6      | Y6   | AA1     | AB1  | AB38    | AC38 | AE1     | AF1  | AG6     | AH6  |
| R8      | T8  | U8      | V8  | W8      | Y8   | AA4     | AB4  | AB41    | AC41 | AE4     | AF4  | AG8     | AH8  |
| R10     | T10 | U10     | V10 | W10     | Y10  | AA6     | AB6  | AC1     | AD1  | AE6     | AF6  | AG10    | AH10 |
| R12     | T12 | U12     | V12 | W12     | Y12  | AA8     | AB8  | AC4     | AD4  | AE8     | AF8  | AG12    | AH12 |
| R14     | T14 | U14     | V14 | W14     | Y14  | AA10    | AB10 | AC6     | AD6  | AE10    | AF10 | AG14    | AH14 |
| R15     | R16 | U16     | V16 | W16     | Y16  | AA12    | AB12 | AC8     | AD8  | AE12    | AF12 | AG16    | AG17 |
| R17     | R18 | U17     | U18 | W18     | Y18  | AA14    | AB14 | AC10    | AD10 | AE14    | AF14 | AG18    | AG19 |
| R19     | R20 | U19     | U20 | W19     | W20  | AA16    | AB16 | AC12    | AD12 | AE16    | AF16 | AG20    | AG21 |
| R21     | R22 | U21     | U22 | W21     | NC   | AA18    | AB18 | AC14    | AD14 | AE18    | AE19 | AG22    | AG23 |
| R23     | R24 | U23     | U24 | W22     | NC   | AA20    | NC   | AC16    | AD16 | AE20    | AE21 | AG24    | AG25 |
| R25     | R26 | U25     | V25 | W23     | Y23  | AA21    | NC   | AC18    | AD18 | AE22    | AE23 | AG26    | AG27 |
| R27     | T27 | U27     | V27 | W25     | Y25  | AA22    | NC   | AC20    | AC21 | AE24    | AE25 | AG29    | AH29 |
| R29     | T29 | U29     | V29 | W27     | Y27  | AA23    | AB23 | AC22    | AC23 | AE27    | AF27 | AG31    | AH31 |
| R31     | T31 | U31     | V31 | W29     | Y29  | AA25    | AB25 | AC25    | AD25 | AE29    | AF29 | AG33    | AH33 |
| R33     | T33 | U33     | V33 | W31     | Y31  | AA27    | AB27 | AC27    | AD27 | AE31    | AF31 | AG35    | AH35 |
| R35     | T35 | U35     | V35 | W33     | Y33  | AA29    | AB29 | AC29    | AD29 | AE33    | AF33 | AG37    | AH37 |
| R37     | T37 | U37     | V37 | W35     | Y35  | AA31    | AB31 | AC31    | AD31 | AE35    | AF35 | AG39    | AH39 |
| R39     | T39 | U39     | V39 | W37     | Y37  | AA33    | AB33 | AC33    | AD33 | AE37    | AF37 | AG40    | AH40 |
| R40     | T40 | U40     | V40 | W39     | Y39  | AA35    | AB35 | AC35    | AD35 | AE39    | AF39 | AH2     | AJ2  |
| T2      | U2  | V2      | W2  | W40     | Y40  | AA37    | AB37 | AC37    | AD37 | AE40    | AF40 | AH3     | AJ3  |
| T3      | U3  | V3      | W3  | Y2      | AA2  | AA39    | AB39 | AC39    | AD39 | AF2     | AG2  | AH5     | AJ5  |
| T5      | U5  | V5      | W5  | Y3      | AA3  | AA40    | AB40 | AC40    | AD40 | AF3     | AG3  | AH7     | AJ7  |
| T7      | U7  | V7      | W7  | Y5      | AA5  | AB2     | AC2  | AD2     | AE2  | AF5     | AG5  | AH9     | AJ9  |
| T9      | U9  | V9      | W9  | Y7      | AA7  | AB3     | AC3  | AD3     | AE3  | AF7     | AG7  | AH11    | AJ11 |
| T11     | U11 | V11     | W11 | Y9      | AA9  | AB5     | AC5  | AD5     | AE5  | AF9     | AG9  | AH13    | AJ13 |
| T13     | U13 | V13     | W13 | Y11     | AA11 | AB7     | AC7  | AD7     | AE7  | AF11    | AG11 | AH15    | AH16 |
| T15     | U15 | V15     | W15 | Y13     | AA13 | AB9     | AC9  | AD9     | AE9  | AF13    | AG13 | AH17    | AH18 |
| T16     | T17 | V17     | W17 | Y15     | AA15 | AB11    | AC11 | AD11    | AE11 | AF15    | AG15 | AH19    | AH20 |
| T18     | T19 | V18     | V19 | Y17     | AA17 | AB13    | AC13 | AD13    | AE13 | AF17    | AF18 | AH21    | AH22 |
| T20     | T21 | V20     | V21 | Y19     | AA19 | AB15    | AC15 | AD15    | AE15 | AF19    | AF20 | AH23    | AH24 |
| T22     | T23 | V22     | V23 | Y20     | NC   | AB17    | AC17 | AD17    | AE17 | AF21    | AF22 | AH25    | AH26 |
| T24     | T25 | V24     | W24 | Y21     | NC   | AB19    | AC19 | AD19    | AD20 | AF23    | AF24 | AH27    | AH28 |
| T26     | U26 | V26     | W26 | Y22     | NC   | AB20    | NC   | AD21    | AD22 | AF25    | AF26 | AH30    | AJ30 |
| T28     | U28 | V28     | W28 | Y24     | AA24 | AB21    | NC   | AD23    | AD24 | AF28    | AG28 | AH32    | AJ32 |
| T30     | U30 | V30     | W30 | Y26     | AA26 | AB22    | NC   | AD26    | AE26 | AF30    | AG30 | AH34    | AJ34 |
| T32     | U32 | V32     | W32 | Y28     | AA28 | AB24    | AC24 | AD28    | AE28 | AF32    | AG32 | AH36    | AJ36 |
| T34     | U34 | V34     | W34 | Y30     | AA30 | AB26    | AC26 | AD30    | AE30 | AF34    | AG34 | AH38    | AJ38 |
| T36     | U36 | V36     | W36 | Y32     | AA32 | AB28    | AC28 | AD32    | AE32 | AF36    | AG36 | AH41    | AJ41 |
| T38     | U38 | V38     | W38 | Y34     | AA34 | AB30    | AC30 | AD34    | AE34 | AF38    | AG38 |         |      |
| T41     | U41 | V41     | W41 | Y36     | AA36 | AB32    | AC32 | AD36    | AE36 | AF41    | AG41 |         |      |

AA21 NO CONNECTION

CONTINUED NEXT PAGE

|   |           |                       |              |
|---|-----------|-----------------------|--------------|
|  |           |                       |              |
| TITLE CCGA1657T1.0-DC416D<br>DUMMY COLUMN GRID ARRAY                                  |           |                       |              |
| SCALE<br>NONE   | SIZE<br>A | DRAWING NO.<br>160193 | REV<br>A     |
| DO NOT SCALE DRAWING  |           |                       | SHEET 4 OF 7 |

| DC PAIR |      |
|---------|------|
| AJ1     | AK1  |
| AJ4     | AK4  |
| AJ6     | AK6  |
| AJ8     | AK8  |
| AJ10    | AK10 |
| AJ12    | AK12 |
| AJ14    | AJ15 |
| AJ16    | AJ17 |
| AJ18    | AJ19 |
| AJ20    | AJ21 |
| AJ22    | AJ23 |
| AJ24    | AJ25 |
| AJ26    | AJ27 |
| AJ28    | AJ29 |
| AJ31    | AK31 |
| AJ33    | AK33 |
| AJ35    | AK35 |
| AJ37    | AK37 |
| AJ39    | AK39 |
| AJ40    | AK40 |
| AK2     | AL2  |
| AK3     | AL3  |
| AK5     | AL5  |
| AK7     | AL7  |
| AK9     | AL9  |
| AK11    | AL11 |
| AK13    | AK14 |
| AK15    | AK16 |
| AK17    | AK18 |
| AK19    | AK20 |
| AK21    | AK22 |
| AK23    | AK24 |
| AK25    | AK26 |
| AK27    | AK28 |
| AK29    | AK30 |
| AK32    | AL32 |
| AK34    | AL34 |
| AK36    | AL36 |
| AK38    | AL38 |
| AK41    | AL41 |

| DC PAIR |      |
|---------|------|
| AL1     | AM1  |
| AL4     | AM4  |
| AL6     | AM6  |
| AL8     | AM8  |
| AL10    | AM10 |
| AL12    | AL13 |
| AL14    | AL15 |
| AL16    | AL17 |
| AL18    | AL19 |
| AL20    | AL21 |
| AL22    | AL23 |
| AL24    | AL25 |
| AL26    | AL27 |
| AL28    | AL29 |
| AL30    | AL31 |
| AL33    | AM33 |
| AL35    | AM35 |
| AL37    | AM37 |
| AL39    | AM39 |
| AL40    | AM40 |
| AM2     | AN2  |
| AM3     | AN3  |
| AM5     | AN5  |
| AM7     | AN7  |
| AM9     | AN9  |
| AM11    | AM12 |
| AM13    | AM14 |
| AM15    | AM16 |
| AM17    | AM18 |
| AM19    | AM20 |
| AM21    | AM22 |
| AM23    | AM24 |
| AM25    | AM26 |
| AM27    | AM28 |
| AM29    | AM30 |
| AM31    | AM32 |
| AM34    | AN34 |
| AM36    | AN36 |
| AM38    | AN38 |
| AM41    | AN41 |

| DC PAIR |      |
|---------|------|
| AN1     | AP1  |
| AN4     | AP4  |
| AN6     | AP6  |
| AN8     | AP8  |
| AN10    | AN11 |
| AN12    | AN13 |
| AN14    | AN15 |
| AN16    | AN17 |
| AN18    | AN19 |
| AN20    | AN21 |
| AN22    | AN23 |
| AN24    | AN25 |
| AN26    | AN27 |
| AN28    | AN29 |
| AN30    | AN31 |
| AN32    | AN33 |
| AN35    | AP35 |
| AN37    | AP37 |
| AN39    | AP39 |
| AN40    | AP40 |
| AP2     | AR2  |
| AP3     | AR3  |
| AP5     | AR5  |
| AP7     | AR7  |
| AP9     | AP10 |
| AP11    | AP12 |
| AP13    | AP14 |
| AP15    | AP16 |
| AP17    | AP18 |
| AP19    | AP20 |
| AP21    | AP22 |
| AP23    | AP24 |
| AP25    | AP26 |
| AP27    | AP28 |
| AP29    | AP30 |
| AP31    | AP32 |
| AP33    | AP34 |
| AP36    | AR36 |
| AP38    | AR38 |
| AP41    | AR41 |

| DC PAIR |      |
|---------|------|
| AR1     | AT1  |
| AR4     | AT4  |
| AR6     | AT6  |
| AR8     | AR9  |
| AR10    | AR11 |
| AR12    | AR13 |
| AR14    | AR15 |
| AR16    | AR17 |
| AR18    | AR19 |
| AR20    | AR21 |
| AR22    | AR23 |
| AR24    | AR25 |
| AR26    | AR27 |
| AR28    | AR29 |
| AR30    | AR31 |
| AR32    | AR33 |
| AR34    | AR35 |
| AR37    | AT37 |
| AR39    | AT39 |
| AR40    | AT40 |
| AT2     | AU2  |
| AT3     | AU3  |
| AT5     | AU5  |
| AT7     | AT8  |
| AT9     | AT10 |
| AT11    | AT12 |
| AT13    | AT14 |
| AT15    | AT16 |
| AT17    | AT18 |
| AT19    | AT20 |
| AT21    | AT22 |
| AT23    | AT24 |
| AT25    | AT26 |
| AT27    | AT28 |
| AT29    | AT30 |
| AT31    | AT32 |
| AT33    | AT34 |
| AT35    | AT36 |
| AT38    | AU38 |
| AT41    | AU41 |

| DC PAIR |      |
|---------|------|
| AU1     | AV1  |
| AU4     | AV4  |
| AU6     | AU7  |
| AU8     | AU9  |
| AU10    | AU11 |
| AU12    | AU13 |
| AU14    | AU15 |
| AU16    | AU17 |
| AU18    | AU19 |
| AU20    | AU21 |
| AU22    | AU23 |
| AU24    | AU25 |
| AU26    | AU27 |
| AU28    | AU29 |
| AU30    | AU31 |
| AU32    | AU33 |
| AU34    | AU35 |
| AU36    | AU37 |
| AU39    | AV39 |
| AU40    | AV40 |
| AV2     | AW2  |
| AV3     | AW3  |
| AV5     | AV6  |
| AV7     | AV8  |
| AV9     | AV10 |
| AV11    | AV12 |
| AV13    | AV14 |
| AV15    | AV16 |
| AV17    | AV18 |
| AV19    | AV20 |
| AV21    | AV22 |
| AV23    | AV24 |
| AV25    | AV26 |
| AV27    | AV28 |
| AV29    | AV30 |
| AV31    | AV32 |
| AV33    | AV34 |
| AV35    | AV36 |
| AV37    | AV38 |
| AV41    | BA38 |

| DC PAIR |      |
|---------|------|
| AW4     | AW5  |
| AW6     | AW7  |
| AW8     | AW9  |
| AW10    | AW11 |
| AW12    | AW13 |
| AW14    | AW15 |
| AW16    | AW17 |
| AW18    | AW19 |
| AW20    | AW21 |
| AW22    | AW23 |
| AW24    | AW25 |
| AW26    | AW27 |
| AW28    | AW29 |
| AW30    | AW31 |
| AW32    | AW33 |
| AW34    | AW35 |
| AW36    | AW37 |
| AW38    | AW39 |
| AW40    | AY39 |
| AY3     | AY4  |
| AY5     | AY6  |
| AY7     | AY8  |
| AY9     | AY10 |
| AY11    | AY12 |
| AY13    | AY14 |
| AY15    | AY16 |
| AY17    | AY18 |
| AY19    | AY20 |
| AY21    | AY22 |
| AY23    | AY24 |
| AY25    | AY26 |
| AY27    | AY28 |
| AY29    | AY30 |
| AY31    | AY32 |
| AY33    | AY34 |
| AY35    | AY36 |
| AY37    | AY38 |

| DC PAIR |      |
|---------|------|
| BA4     | BA5  |
| BA6     | BA7  |
| BA8     | BA9  |
| BA10    | BA11 |
| BA12    | BA13 |
| BA14    | BA15 |
| BA16    | BA17 |
| BA18    | BA19 |
| BA20    | BA21 |
| BA22    | BA23 |
| BA24    | BA25 |
| BA26    | BA27 |
| BA28    | BA29 |
| BA30    | BA31 |
| BA32    | BA33 |
| BA34    | BA35 |
| BA36    | BA37 |

## NET LIST DAISY CHAIN CONNECTION TABLE

|  |           |                       |              |
|--|-----------|-----------------------|--------------|
| <b>TopLine®</b>                                      |           |                       |              |
| TITLE CCGA1657T1.0-DC416D<br>DUMMY COLUMN GRID ARRAY |           |                       |              |
| SCALE<br>NONE  | SIZE<br>A | DRAWING NO.<br>160193 | REV<br>A     |
| DO NOT SCALE DRAWING                                 |           |                       | SHEET 5 OF 7 |

# SOLDER PIN OPTIONS

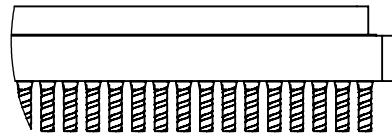
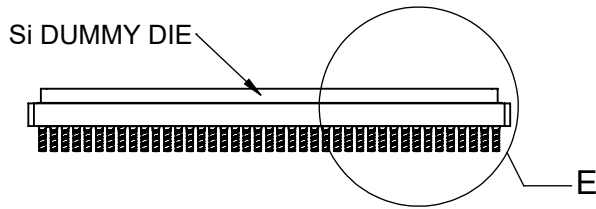

DETAIL E  
SCALE 3 : 1

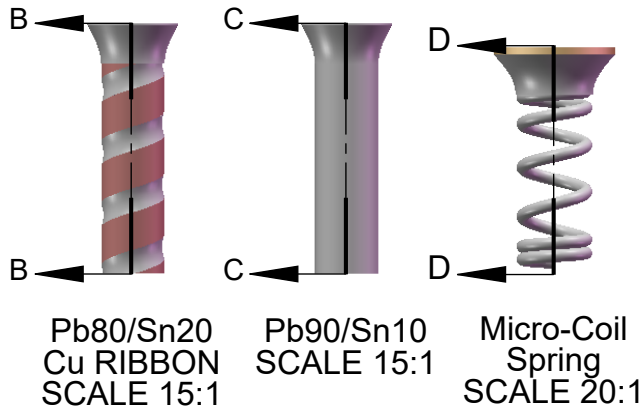
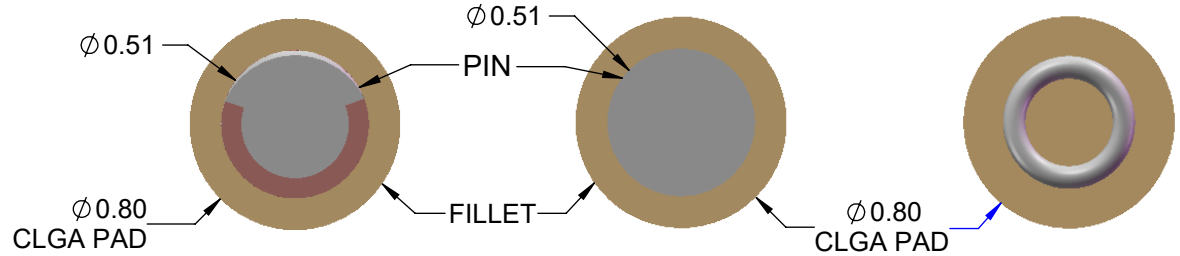
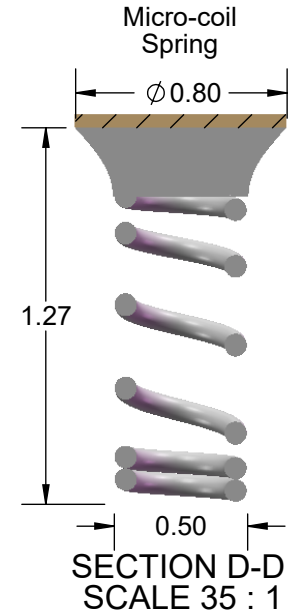
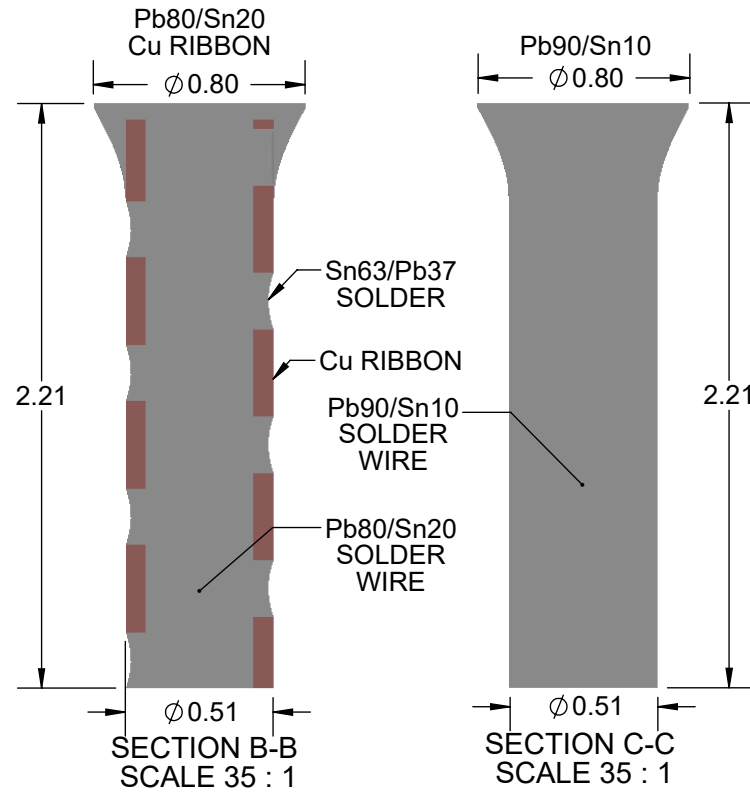

| PART NUMBER OPTIONS  |           |                        |
|----------------------|-----------|------------------------|
| PART NUMBER          | DUMMY DIE | SOLDER PIN             |
| CCGA1657T1.0-DC416D  | YES       | Pb80/Sn20<br>Cu RIBBON |
| CCGA1657T1.0A-DC416D | YES       | Pb90/Sn10              |
| CCGA1657T1.0M-DC416D | YES       | Micro-Coil             |
| CLGA1657T1.0-DC416D  | YES       | NONE                   |
| CLGA1657T1.0-DC416   | NO        | NONE                   |

| TITLE  |      |             |              |
|--|------|-------------|--------------|
| CCGA1657T1.0-DC416D<br>DUMMY COLUMN GRID ARRAY |      |             |              |
| SCALE  | SIZE | DRAWING NO. | REV          |
| 35:1   | A    | 160193      | A            |
| DO NOT SCALE DRAWING                           |      |             | SHEET 6 OF 7 |



**MODEL CCGA1657T1.0M-DC416D  
MICRO-COIL SPRING**

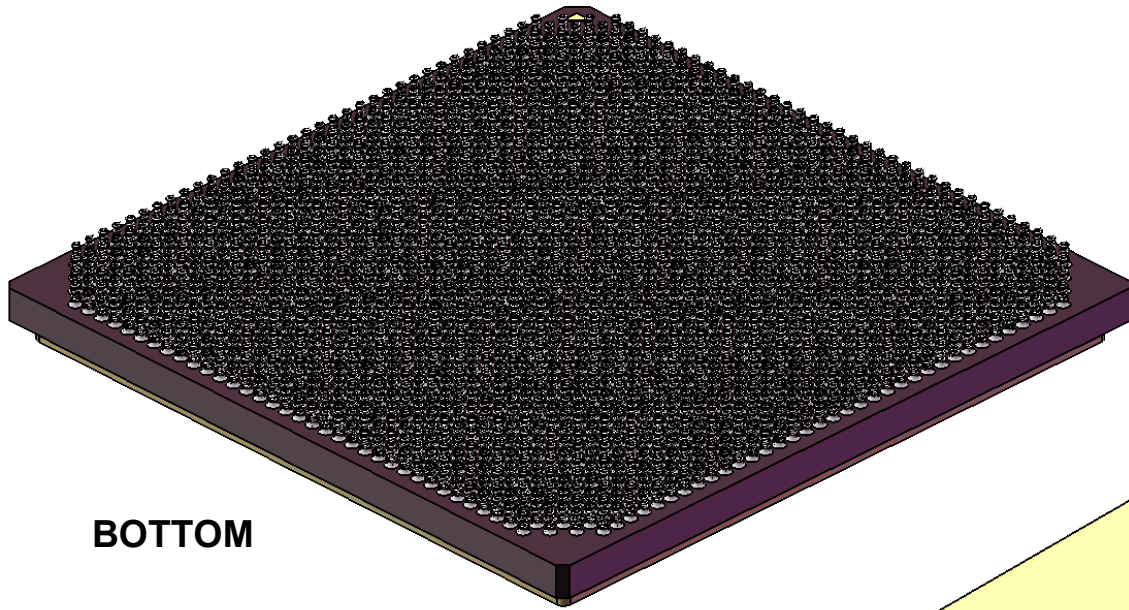

**BOTTOM**

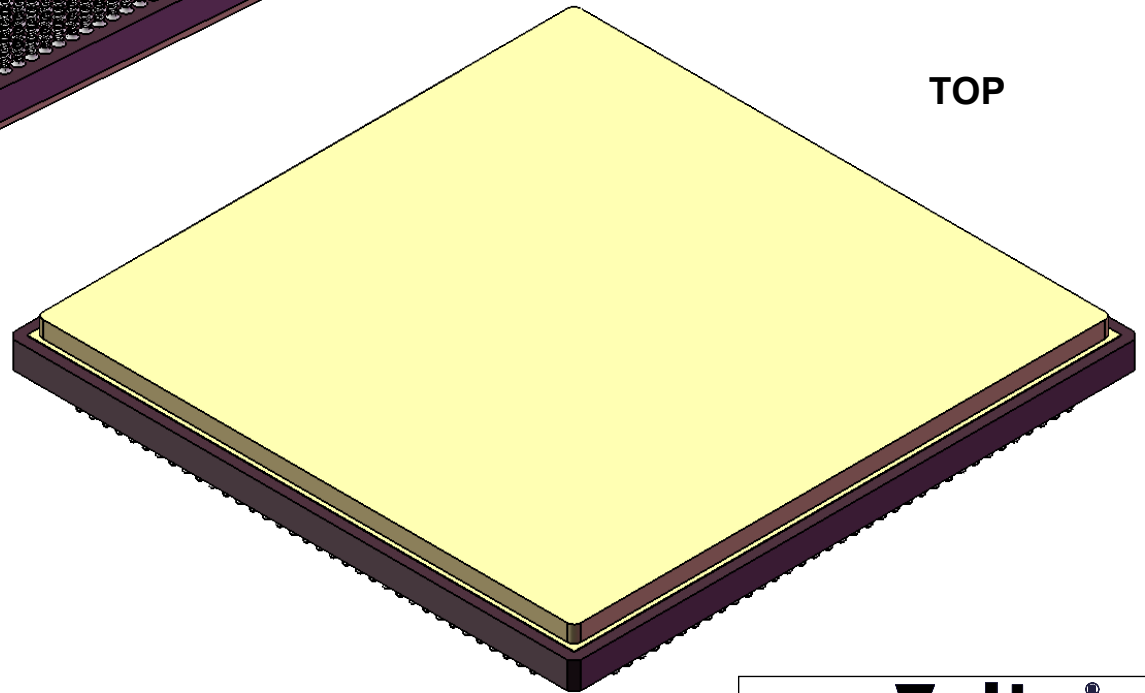

**TOP**

**TopLine®**

TITLE CCGA1657T1.0-DC416D  
DUMMY COLUMN GRID ARRAY

|                |           |                       |          |
|----------------|-----------|-----------------------|----------|
| SCALE<br>2.5:1 | SIZE<br>A | DRAWING NO.<br>160193 | REV<br>A |
|----------------|-----------|-----------------------|----------|

DO NOT SCALE DRAWING

SHEET 7 OF 7