

BOTTOM VIEW

50 48 46 44 42 40 38 36 34 32 30 28 26 24 22 20 18 16 14 12 10 8 6 4 2
51 49 47 45 43 41 39 37 35 33 31 29 27 25 23 21 19 17 15 13 11 9 7 5 3 1

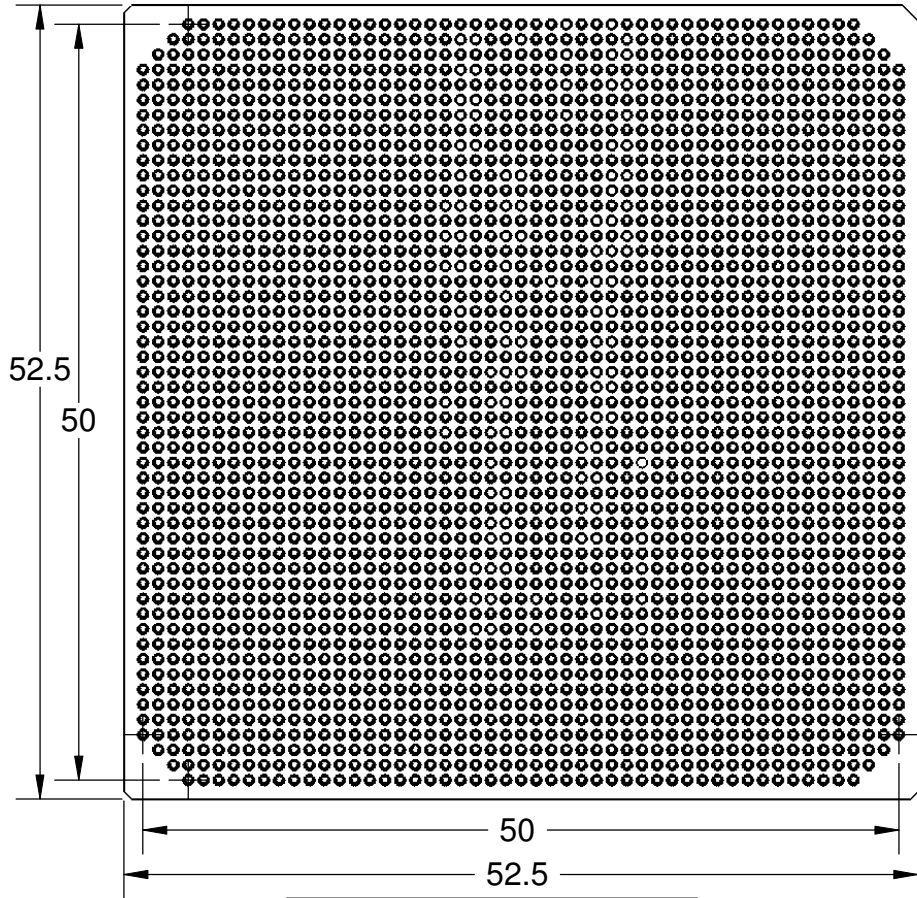

DIMENSIONS			
SYMBOL	MIN.	NOM.	MAX.
A	2.30	3.00	3.30
A ₁	2.30	2.56	2.82
A ₂	2.10	2.20	2.30
Øb	0.51	0.54	0.57
DIE	OPTIONAL	15X15	17X17

PART NUMBER OPTIONS		
PART NUMBER	DUMMY DIE	SOLDER PIN
CCGA2577T1.0-DC517	NO	Pb80/Sn20 Cu RIBBON
CCGA2577T1.0-DC517D	YES	
CCGA2577T1.0A-DC517	NO	Pb90/Sn10
CCGA2577T1.0A-DC517D	YES	

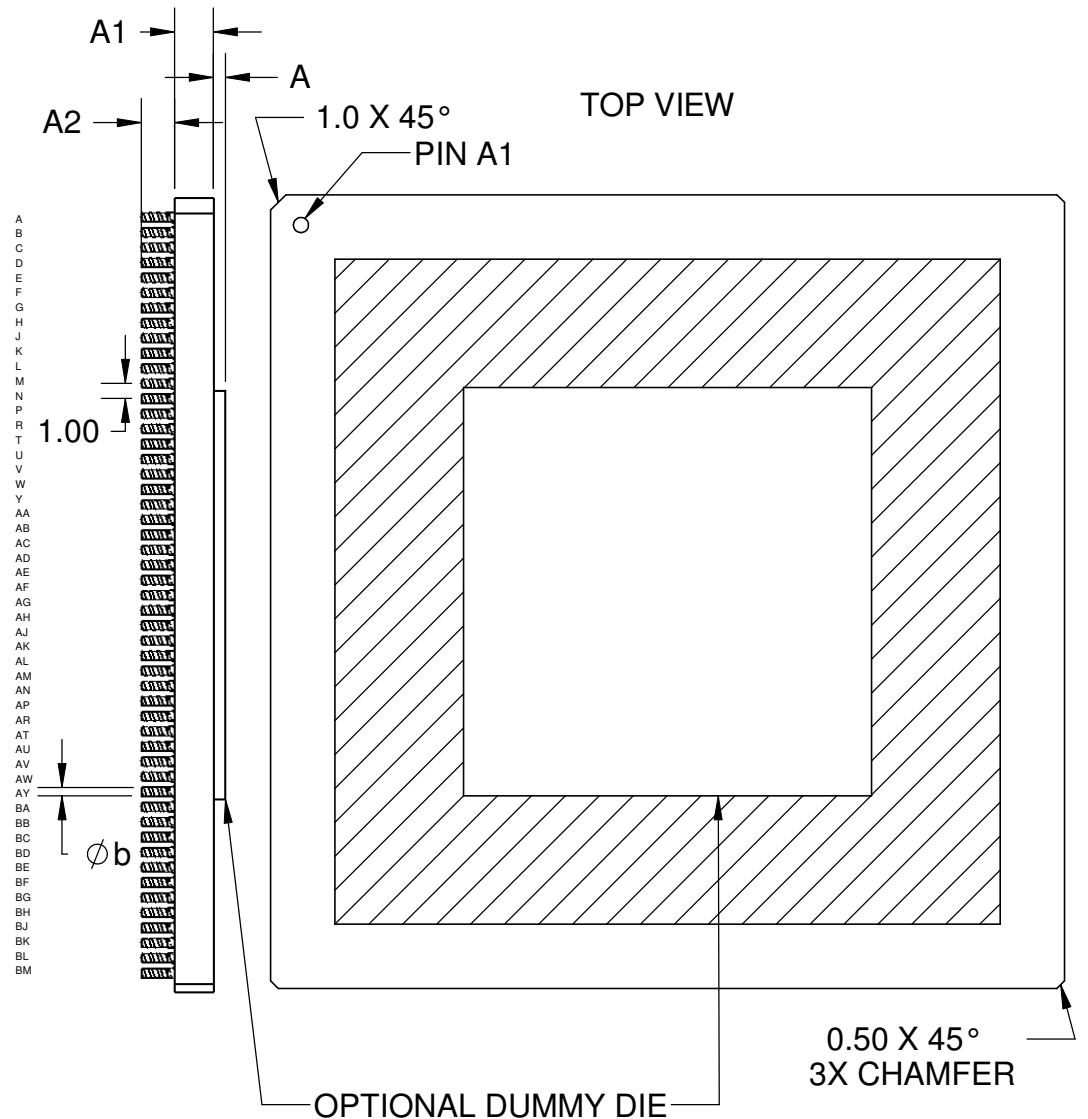

Notes: (Unless Otherwise Specified).
1) DIMENSIONS ARE IN MM.

TOLERANCE UNLESS NOTED		APPROVALS		DATE	TopLine ®				
X.XX	+/- 0.01	DRAWN	J. Hines	1/22/2011	TITLE CCGA2577T1.0-DC517 DUMMY COLUMN GRID ARRAY				
X.XXX	+/- 0.005								
X.XXXX	+/- 0.0005								
ANGLES +/- 0.5°		ENG			SCALE		SIZE	DRAWING NO.	REV
ALL DIMENSIONS IN		MFG			2:1	A	160210	A	
<input type="checkbox"/> INCHES <input checked="" type="checkbox"/> MILLIMETERS		QA			DO NOT SCALE DRAWING				
THIRD ANGLE PROJECTION		CUST			SHEET 1 OF 3				
		REVISED							

DAISY CHAIN PATTERN

COLUMN (BALL) VIEW

50 48 46 44 42 40 38 36 34 32 30 28 26 24 22 20 18 16 14 12 10 8 6 4 2
51 49 47 45 43 41 39 37 35 33 31 29 27 25 23 21 19 17 15 13 11 9 7 5 3 1

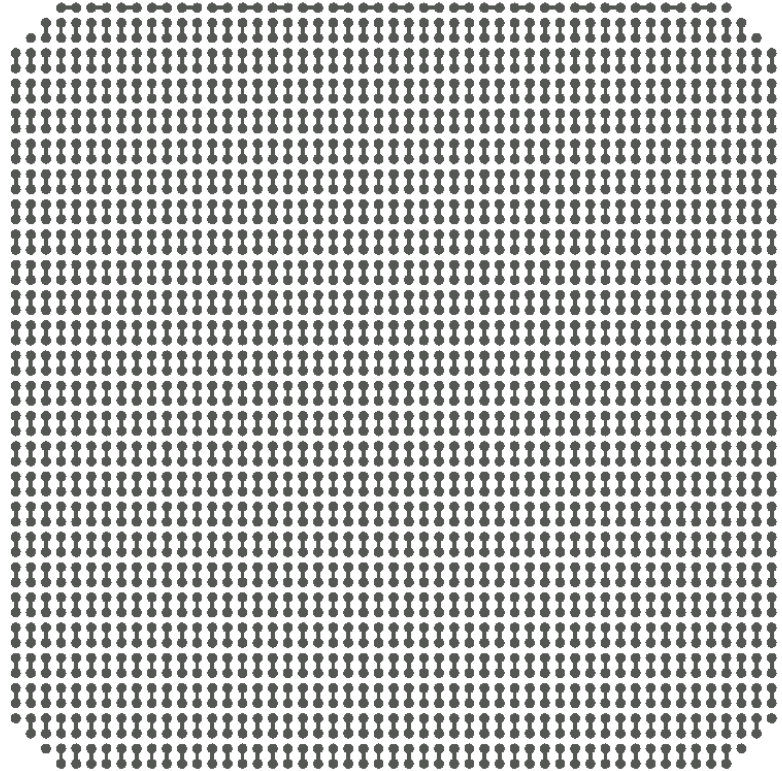

A
B
C
D
E
F
G
H
J
K
L
M
N
P
R
T
U
V
W
Y
AA
AB
AC
AD
AE
AF
AG
AH
AJ
AK
AL
AM
AN
AP
AR
AT
AU
AV
AW
AY
BA
BB
BC
BD
BE
BF
BG
BH
BJ
BK
BL
BM

BOTTOM X-RAY VIEWED FROM TOP

2 4 6 8 10 12 14 16 18 20 22 24 26 28 30 32 34 36 38 40 42 44 46 48 50
1 3 5 7 9 11 13 15 17 19 21 23 25 27 29 31 33 35 37 39 41 43 45 47 49 51

A
B
C
D
E
F
G
H
J
K
L
M
N
P
R
T
U
V
W
Y
AA
AB
AC
AD
AE
AF
AG
AH
AJ
AK
AL
AM
AN
AP
AR
AT
AU
AV
AW
AY
BA
BB
BC
BD
BE
BF
BG
BH
BJ
BK
BL
BM

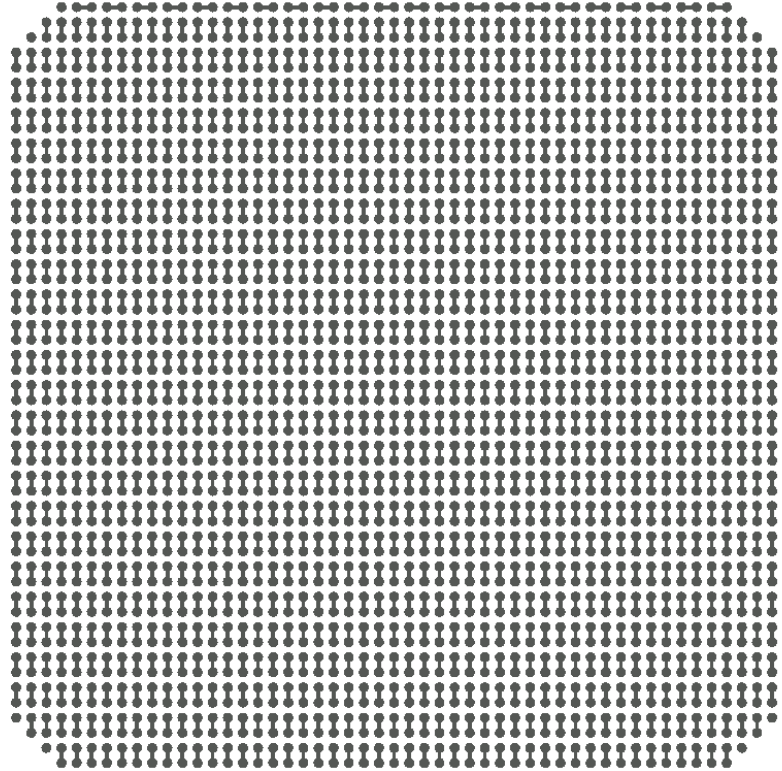

TopLine®

TITLE CCGA2577T1.0-DC517
DUMMY COLUMN GRID ARRAY

SCALE 2:1	SIZE A	DRAWING NO. 160210	REV A
--------------	-----------	-----------------------	----------

DO NOT SCALE DRAWING

SHEET 2 OF 3

SOLDER PIN OPTIONS
SECTION DETAIL

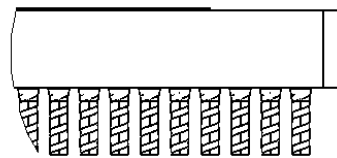
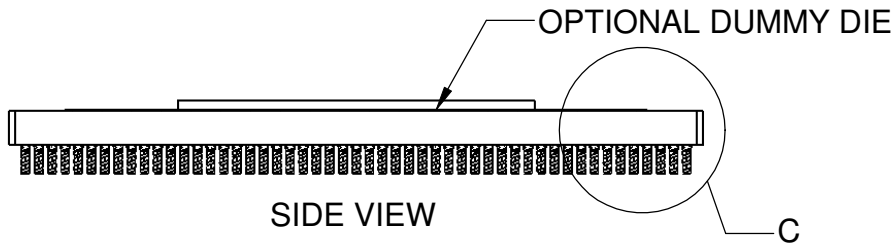

DETAIL C
SCALE 4 : 1

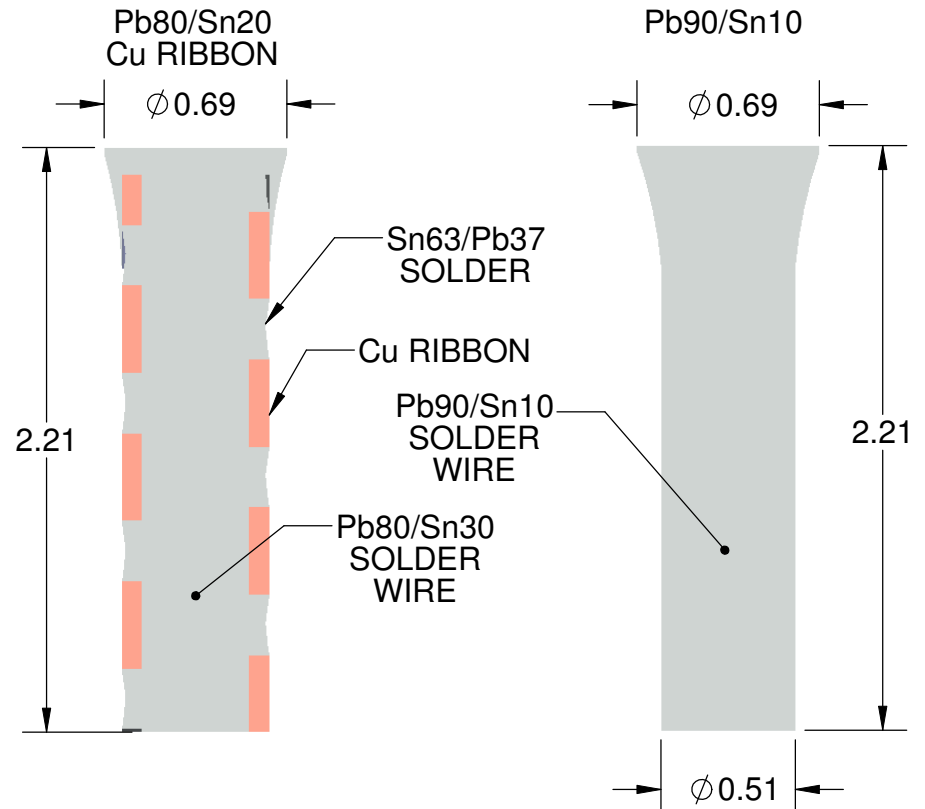

SECTION A-A
SCALE 35 : 1

SECTION B-B
SCALE 35 : 1

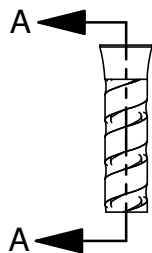

Pb80/Sn20
Cu RIBBON
SCALE 10:1

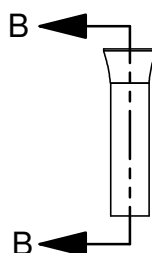

Pb90/Sn10
SCALE 10:1

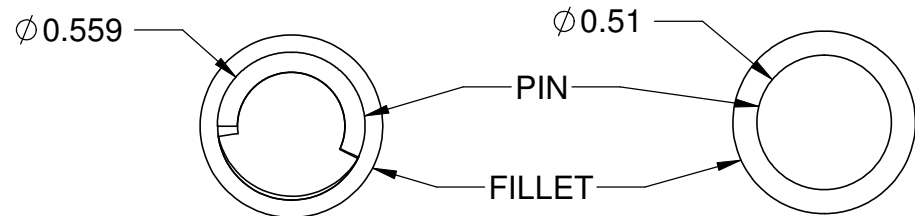

PART NUMBER OPTIONS		
PART NUMBER	DUMMY DIE	SOLDERPIN
CCGA2577T1.0-DC517	NO	Pb80/Sn20 Cu RIBBON
CCGA2577T1.0-DC517D	YES	
CCGA2577T1.0A-DC517	NO	Pb90/Sn10
CCGA2577T1.0A-DC517D	YES	

TopLine [®]			
TITLE CCGA2577T1.0-DC517 DUMMY COLUMN GRID ARRAY			
SCALE 1.75:1	SIZE A	DRAWING NO. 160210	REV A
DO NOT SCALE DRAWING			SHEET 3 OF 3