

SIDE VIEW

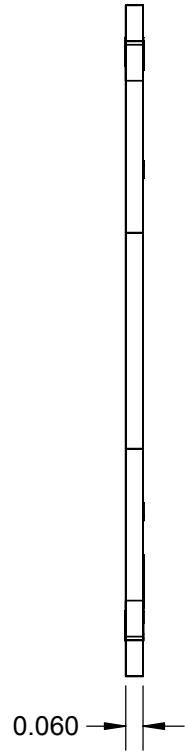

TOP VIEW

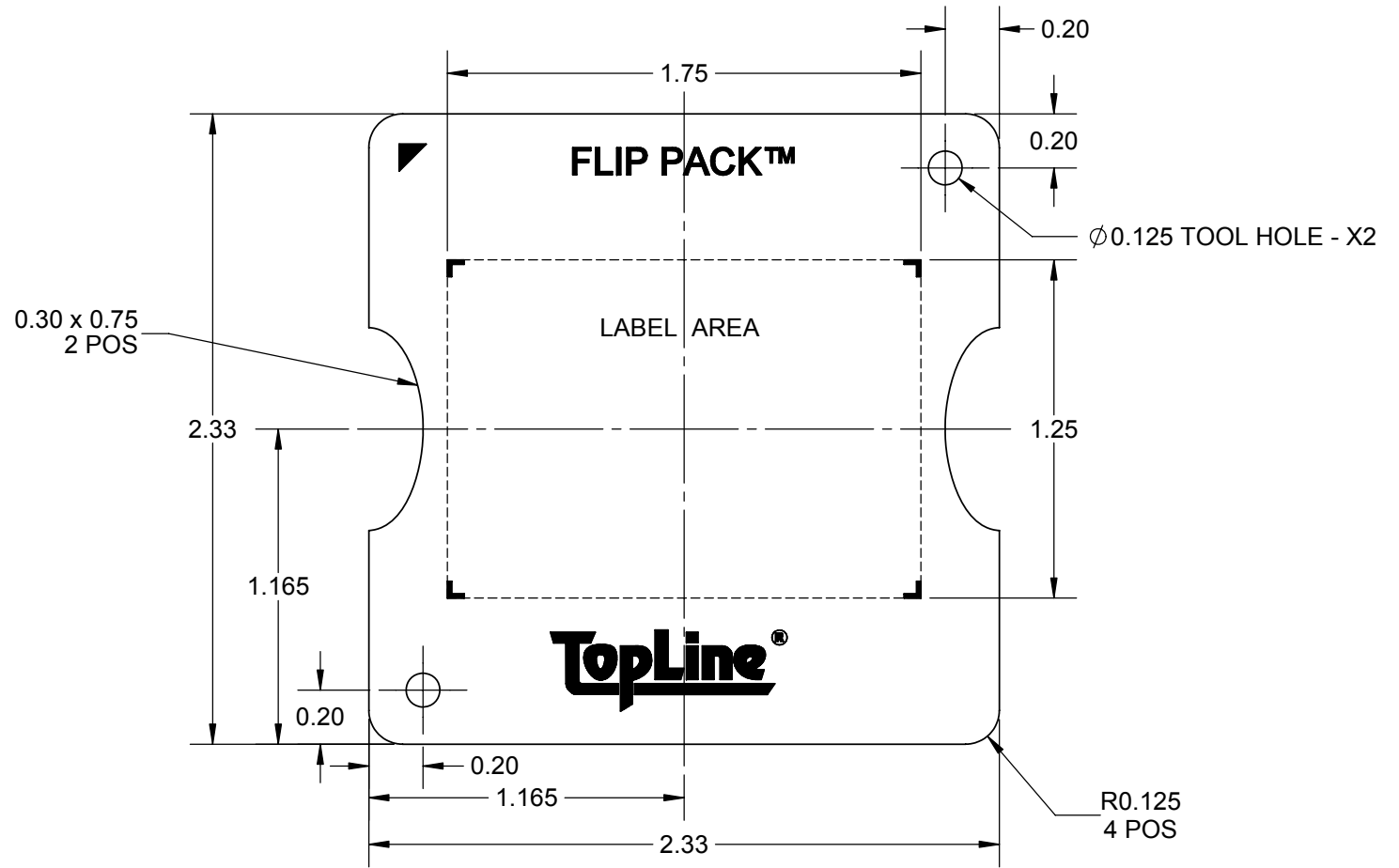

COLOR TABLE		
COLOR	PURPOSE	DWG
BLACK	MICRO-COIL SnPn	301010
BROWN	UNASSIGNED	301011
RED	DUMMY	301012
ORANGE	UNASSIGNED	301013
YELLOW	MICRO-COIL GOLD	301014
GREEN	Pb80/Sn20 COPPER WRAP	301015
BLUE	Pb80/Sn20 PLATED Cu	301016
TAN	Pb90/Sn10 PLATED Cu	301017
GRAY	Pb90/Sn10 PLAIN	301018
WHITE	Pb90/Sn10 COPPER WRAP	301019
NATURAL	UNASSIGNED	301020

- NOTES:
 1. DIMENSIONS IN INCH UNLESS OTHERWISE STATED.
 2. MATERIAL: SEE COLOR TABLE.

APPROVALS		DATE				
DRAWN	T. Au	12/9/2015				
ENG	M. Hart	12/9/2015	TITLE FLIP PACK COVER BLACK			
MFG						
QA			SCALE	SIZE	DRAWING NO.	REV
CUST			3:2	A	301010	A
REVISED			DO NOT SCALE DRAWING			SHEET 1 OF 5

SILK SCREEN

TOP

BOTTOM
(VIEWED FROM TOP)

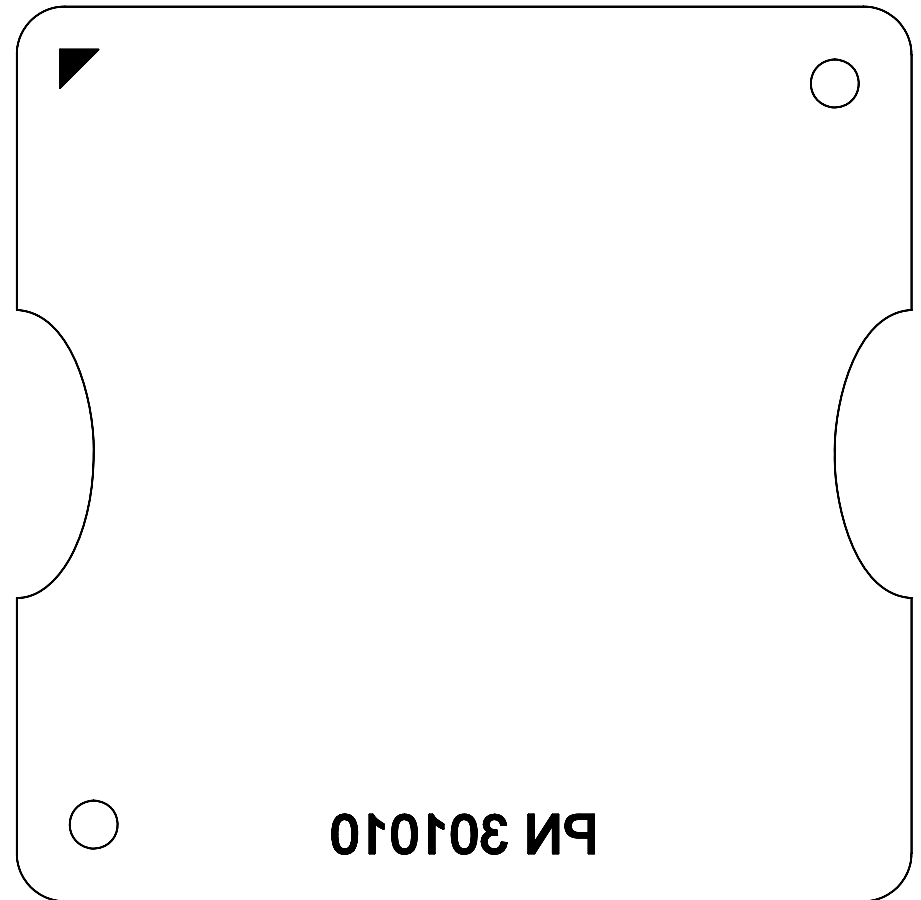
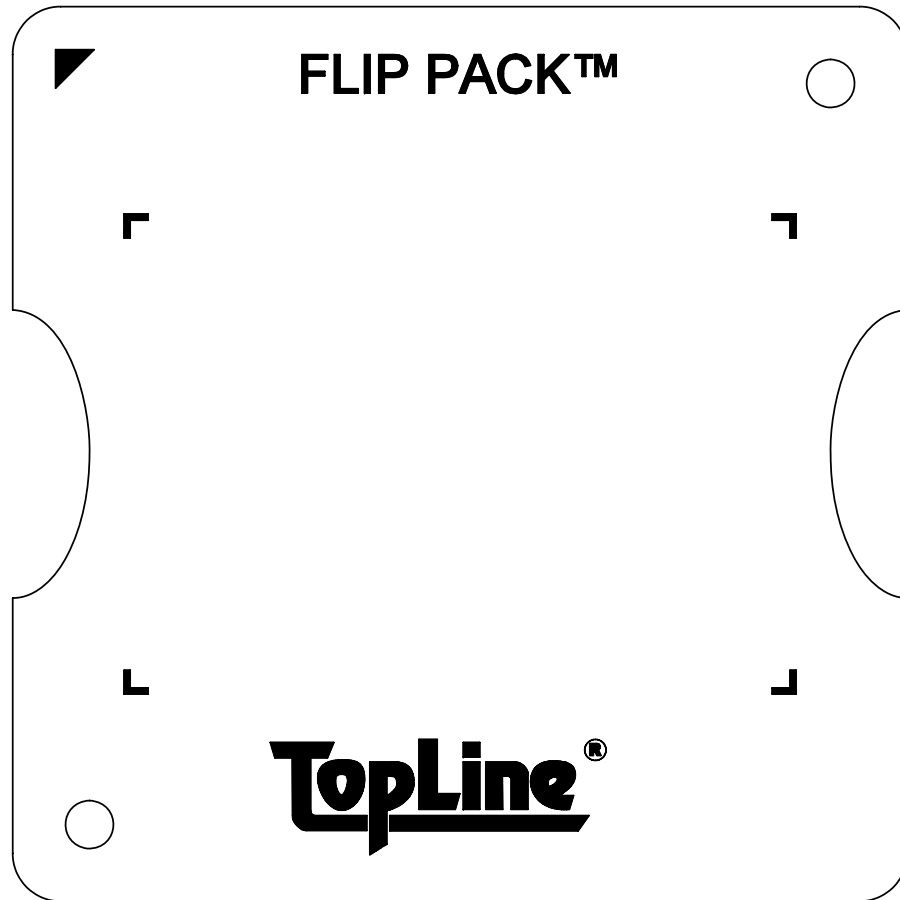

TopLine®			
TITLE		FLIP PACK COVER BLACK	
SCALE	SIZE	DRAWING NO.	REV
2:1	A	301010	A
DO NOT SCALE DRAWING			SHEET 3 OF 5

MODEL

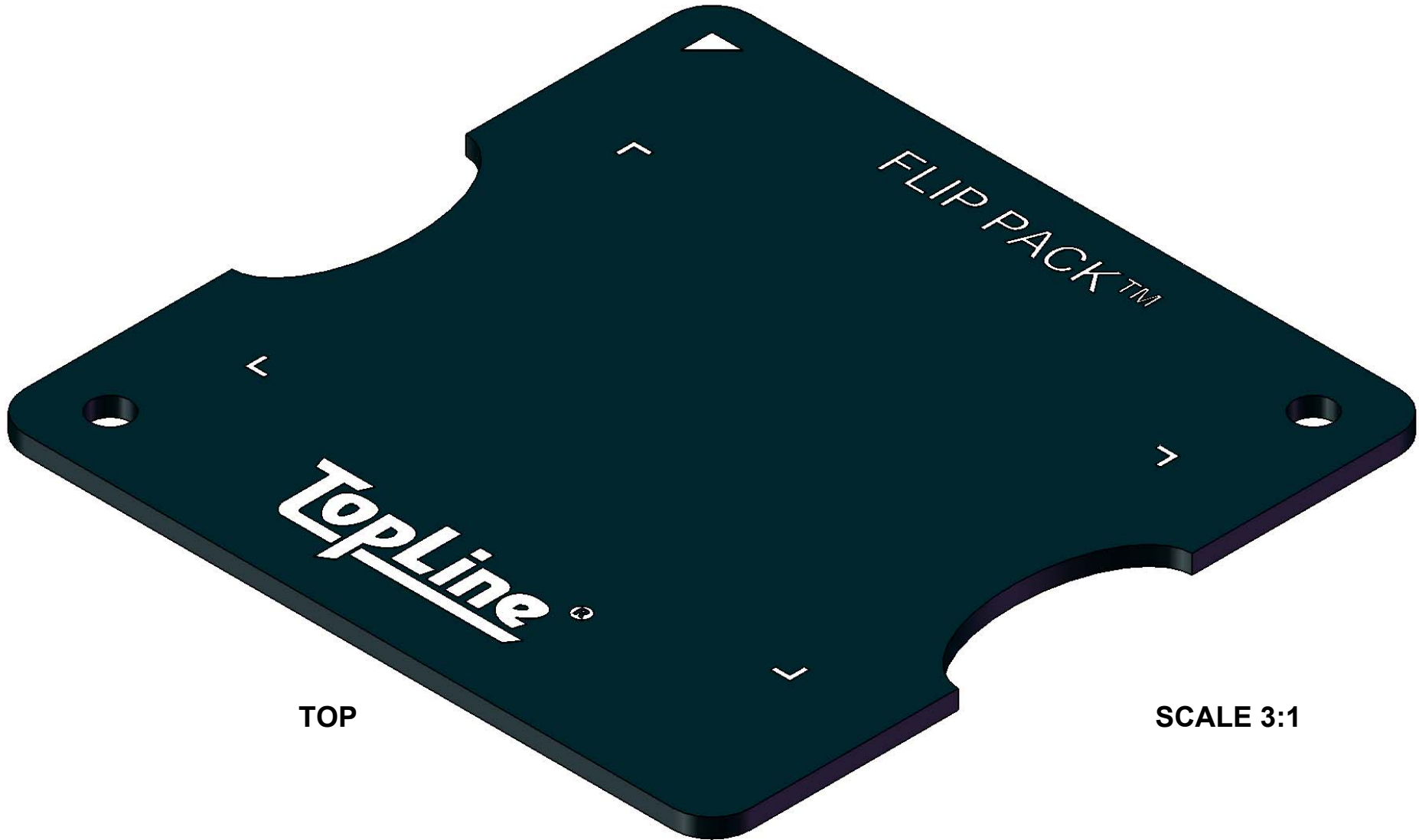

TOP

SCALE 3:1

TopLine®			
TITLE		FLIP PACK COVER BLACK	
SCALE	SIZE	DRAWING NO.	REV
3:1	A	301010	A
DO NOT SCALE DRAWING			SHEET 4 OF 5

MODEL

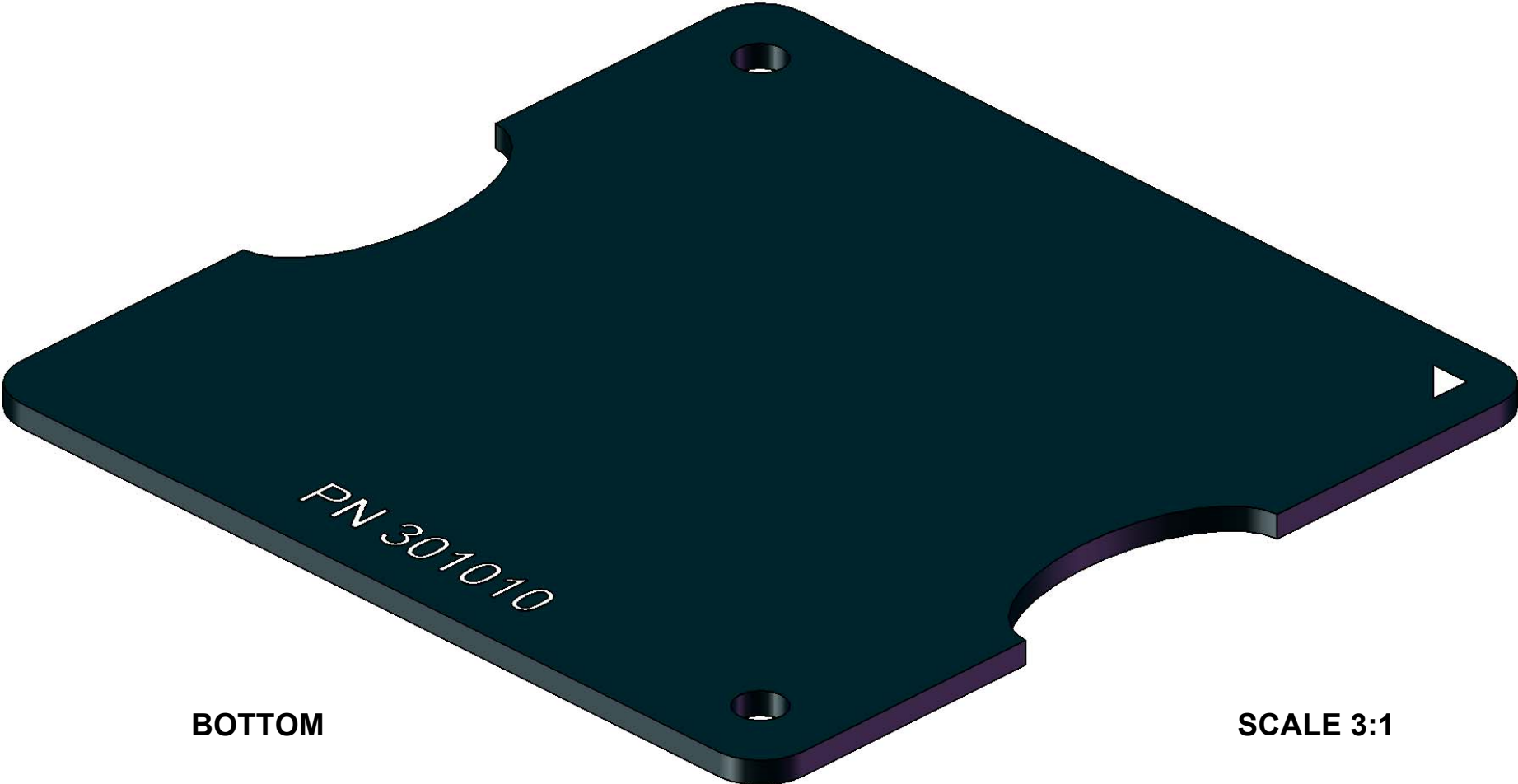

BOTTOM

SCALE 3:1

TopLine[®]			
TITLE		FLIP PACK COVER BLACK	
SCALE	SIZE	DRAWING NO.	REV
3:1	A	301010	A
DO NOT SCALE DRAWING			SHEET 5 OF 5