

EXTERIOR VIEW

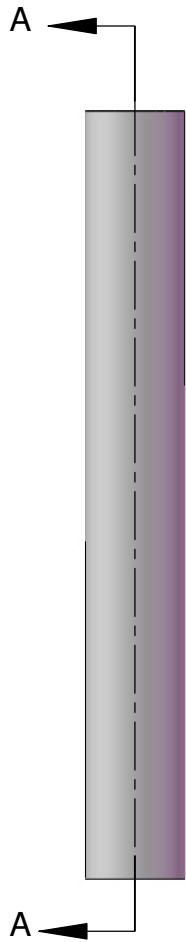

SECTION VIEW

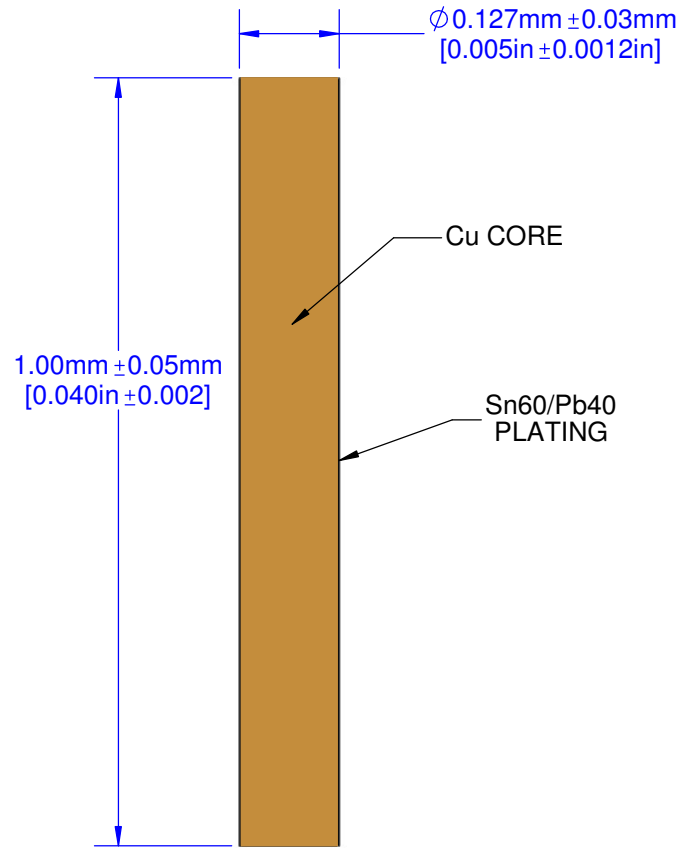

END VIEW

CCGA - LAND PAD

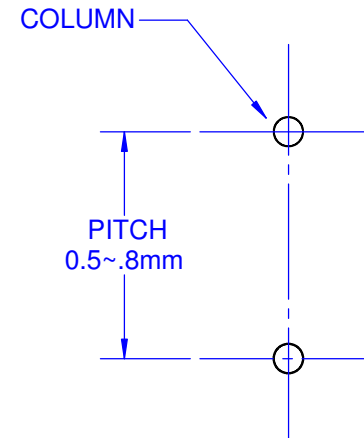
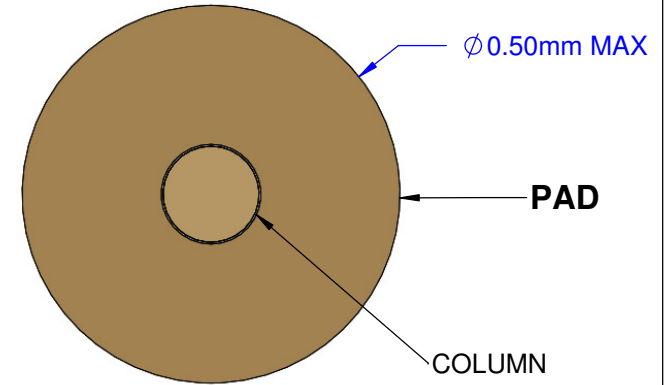

Notes: (Unless Otherwise Specified).

- 1) DIMENSIONS IN mm [INCHES].
- 2) MATERIAL:Cu COPPER ALLOY CDA101 OFE-OFHC
- 3) PLATING:Sn60/Pb40 3.0~5.0um [100~200 MICRO-INCH]

APPROVALS	DATE	TopLine®			
DRAWN T.Au	4/24/2017				
ENG M. Hart	4/24/2017	TITLE CU101P5x40 CCGA COPPER COLUMN			
MFG		SCALE	SIZE	DRAWING NO.	REV
QA		25:1	A	300540	A
CUST		DO NOT SCALE DRAWING			SHEET 1 OF 1
REVISED					