

### TOP VIEW

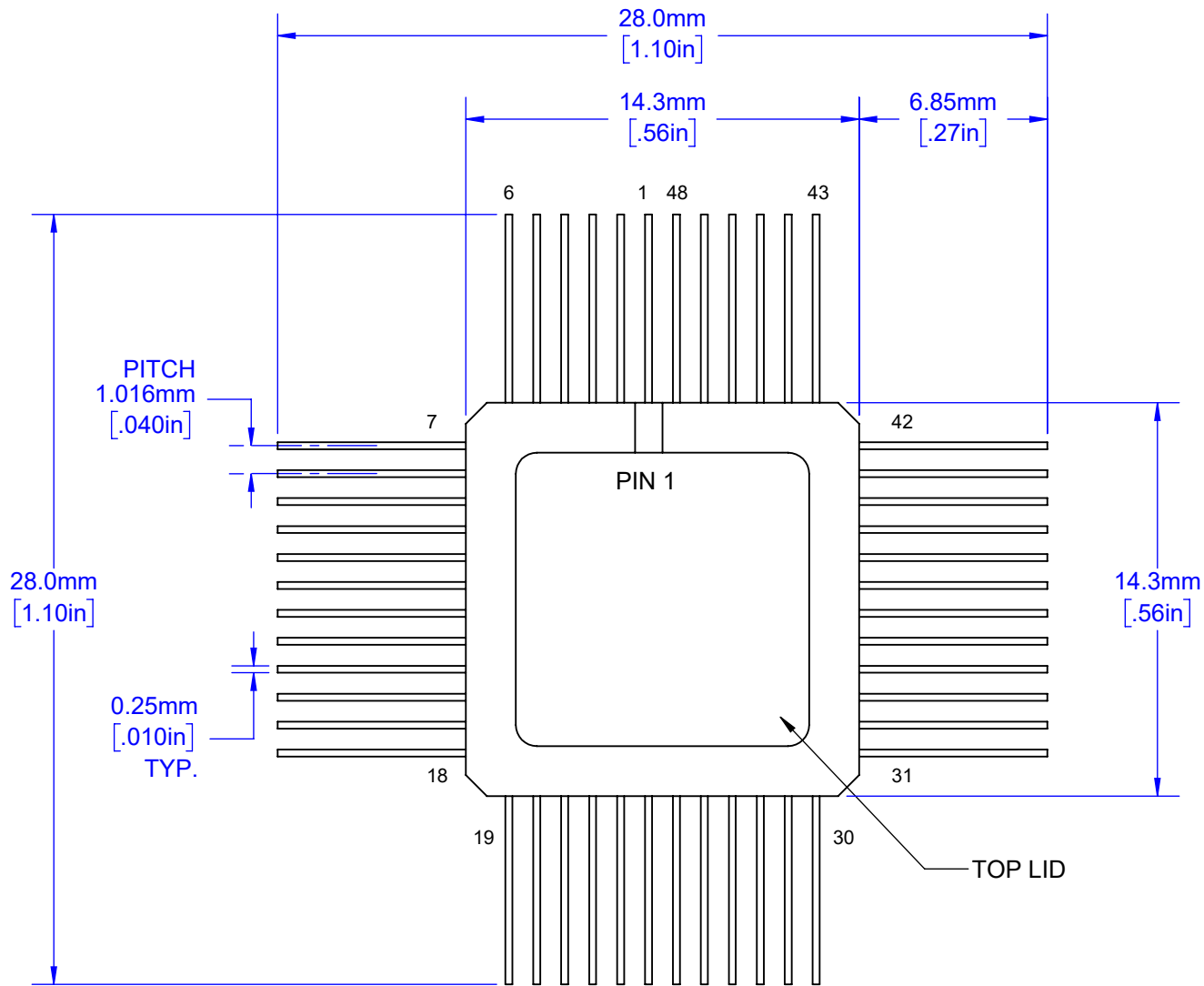

### SIDE VIEW

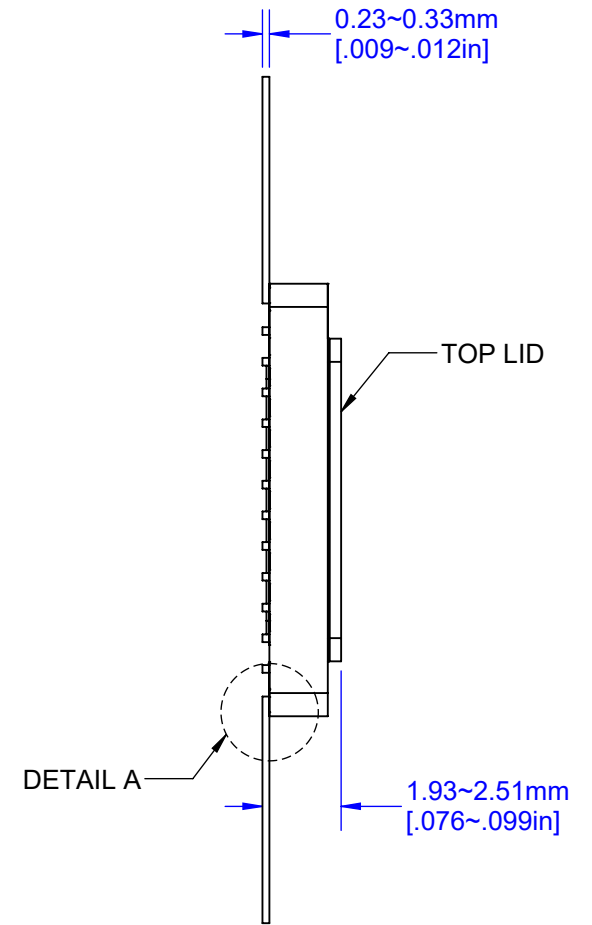

Notes: (Unless Otherwise Specified).

- 1) DIMENSIONS: MM [INCH].
- 2) FLAT LEADS ON ALLOY 42.
- 3) ALL EXPOSED METAL GOLD PLATED (Au).  
60 micro-inch thick gold.

APPROVALS	DATE	<b>TopLine®</b>			
DRAWN T. Au	6/20/2021				
ENG M. Hart	6/20/2021	TITLE CERQUAD48C40B FLAT LEAD - BOTTOM BRAZE			
MFG		SCALE	SIZE	DRAWING NO.	REV
QA		4:1	A	184801	A
CUST		DO NOT SCALE DRAWING			SHEET 1 OF 4
REVISED					

# BOTTOM SIDE

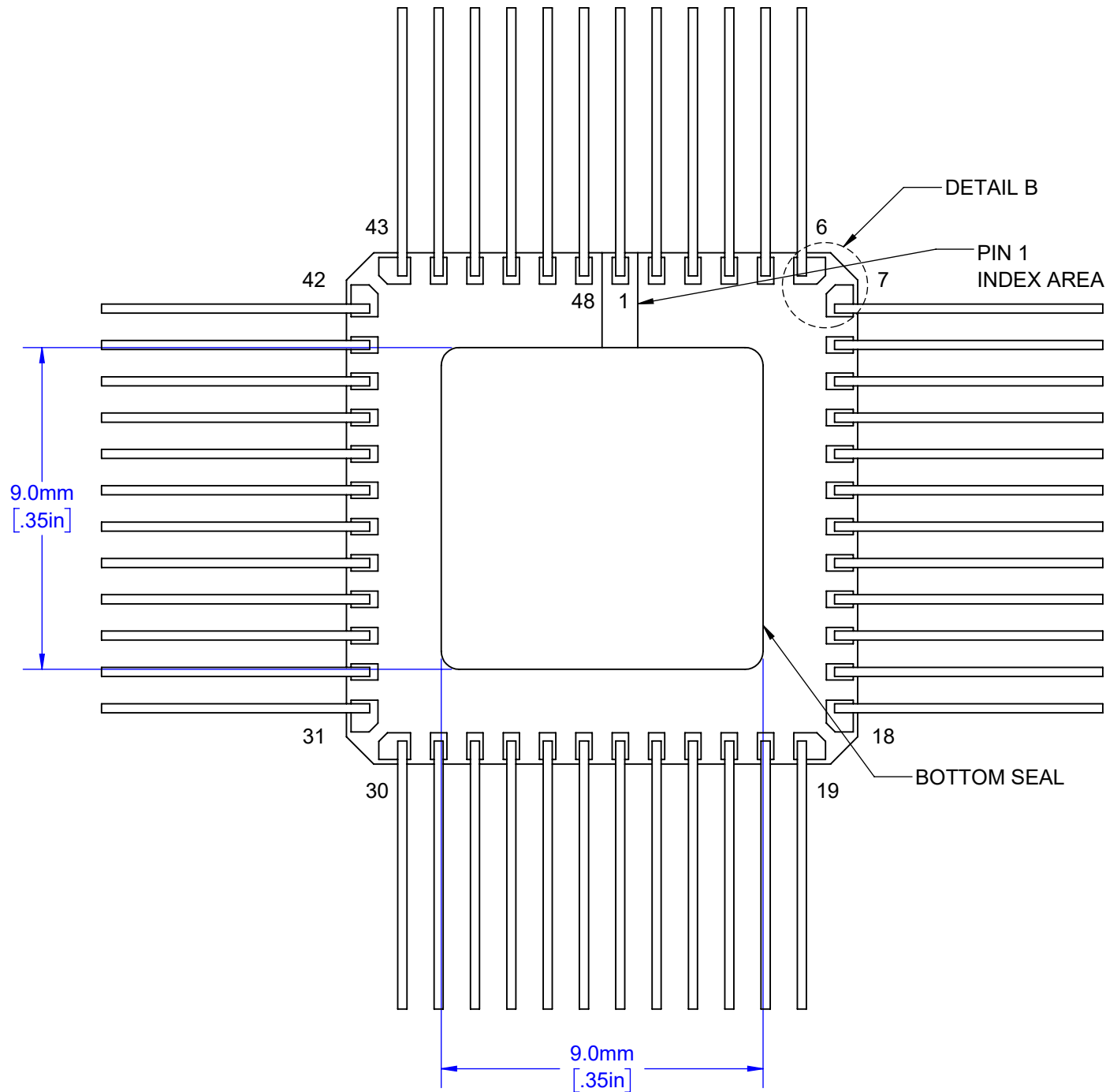

<b>TopLine<sup>®</sup></b>			
TITLE CERQUAD48C40B FLAT LEAD - BOTTOM BRAZE			
SCALE 6:1	SIZE A	DRAWING NO. 184801	REV A
DO NOT SCALE DRAWING			SHEET 2 OF 4

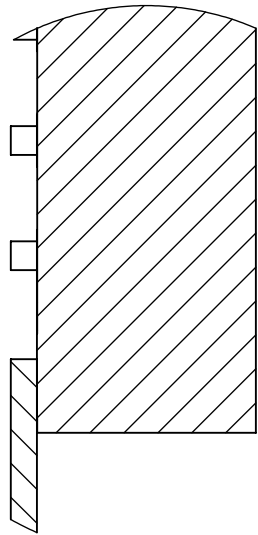

**DETAIL A**

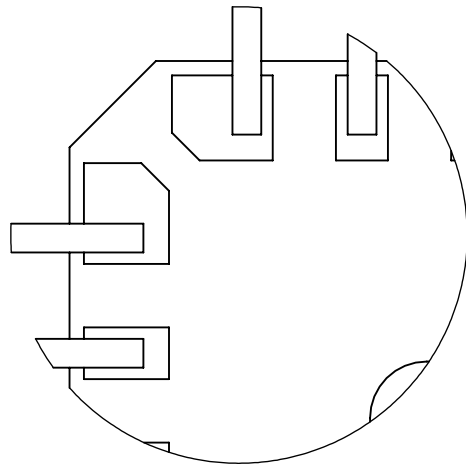

**DETAIL B**

<b>TopLine<sup>®</sup></b>			
TITLE		CERQUAD48C40B FLAT LEAD - BOTTOM BRAZE	
SCALE	SIZE	DRAWING NO.	REV
12:1	A	184801	A
DO NOT SCALE DRAWING			SHEET 3 OF 4

**MODEL SEALED  
WITH LIDS**

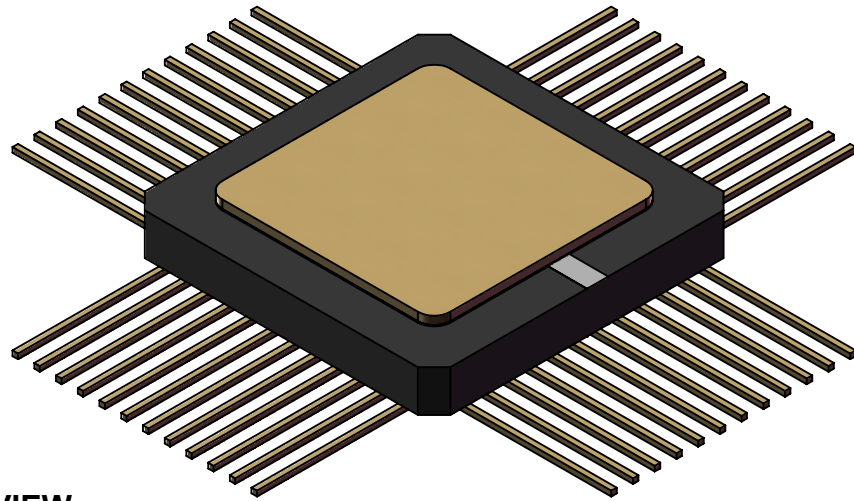

**TOP VIEW**

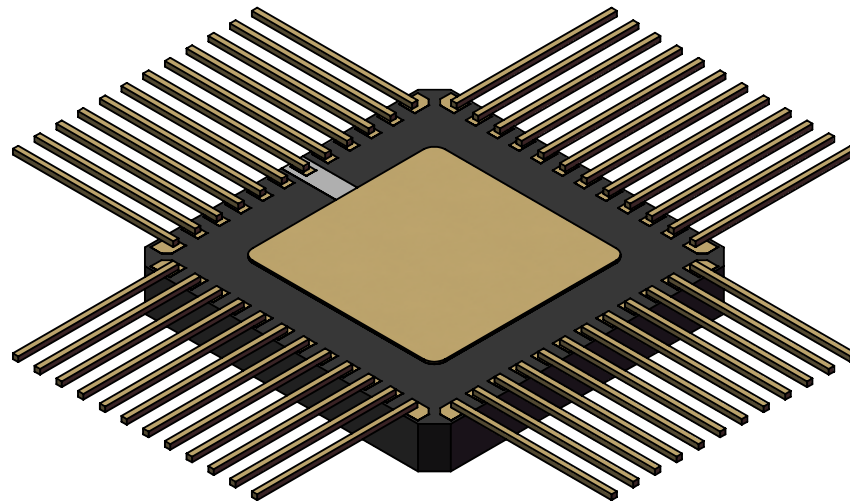

**BOTTOM VIEW**

**TopLine®**

TITLE CERQUAD48C40B  
FLAT LEAD - BOTTOM BRAZE

SCALE 4:1	SIZE A	DRAWING NO. 184801	REV A
--------------	-----------	-----------------------	----------

DO NOT SCALE DRAWING

SHEET 4 OF 4