

Part # **SX3512**
Molded Crystal
 Body Size **8.7 x 3.4mm**
 Dwg SX3512.pdf

TopLine™
 Tel 1-714-898-3830
 info@topline.to

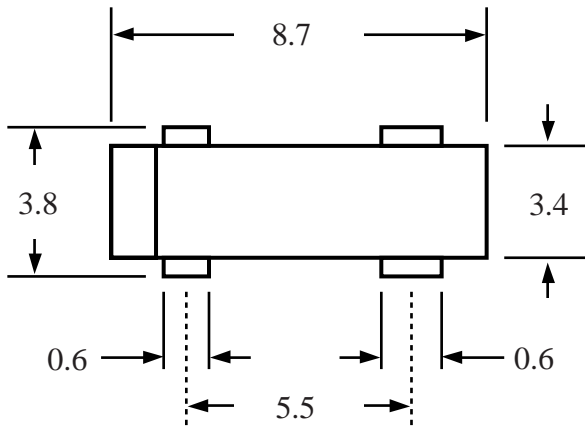

Top View

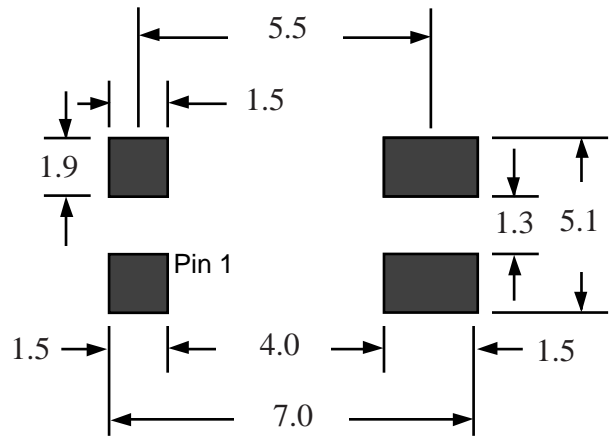

PC Board

Dimensions = mm

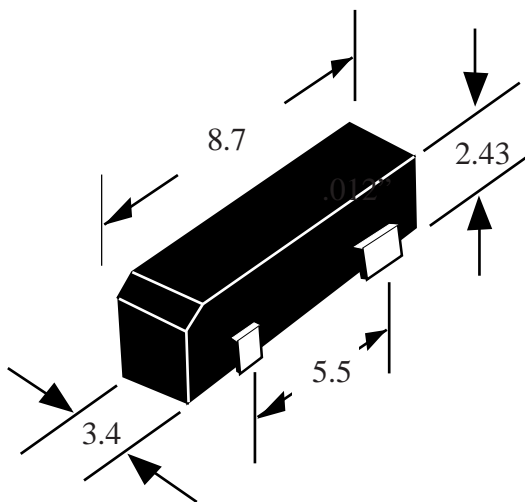

Quick View

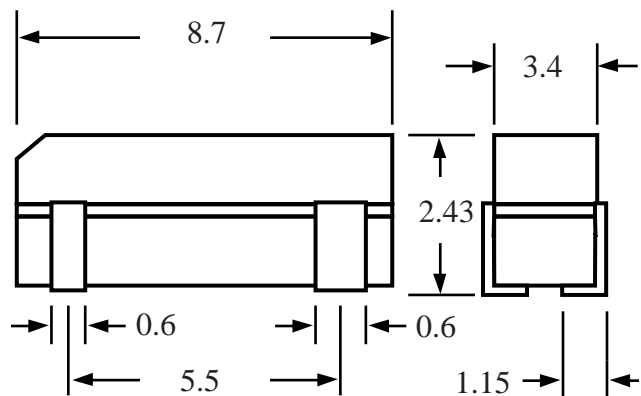

Side View Detail