

TOP VIEW

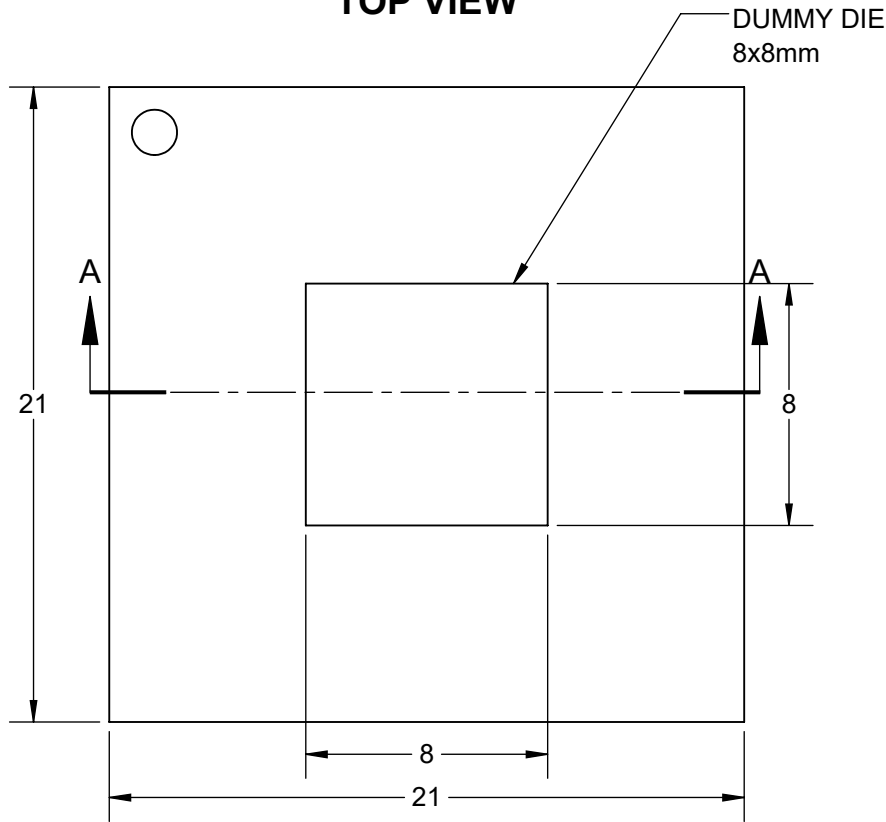

BALL VIEW

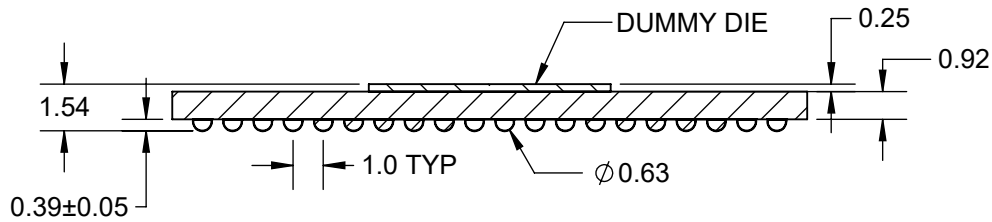
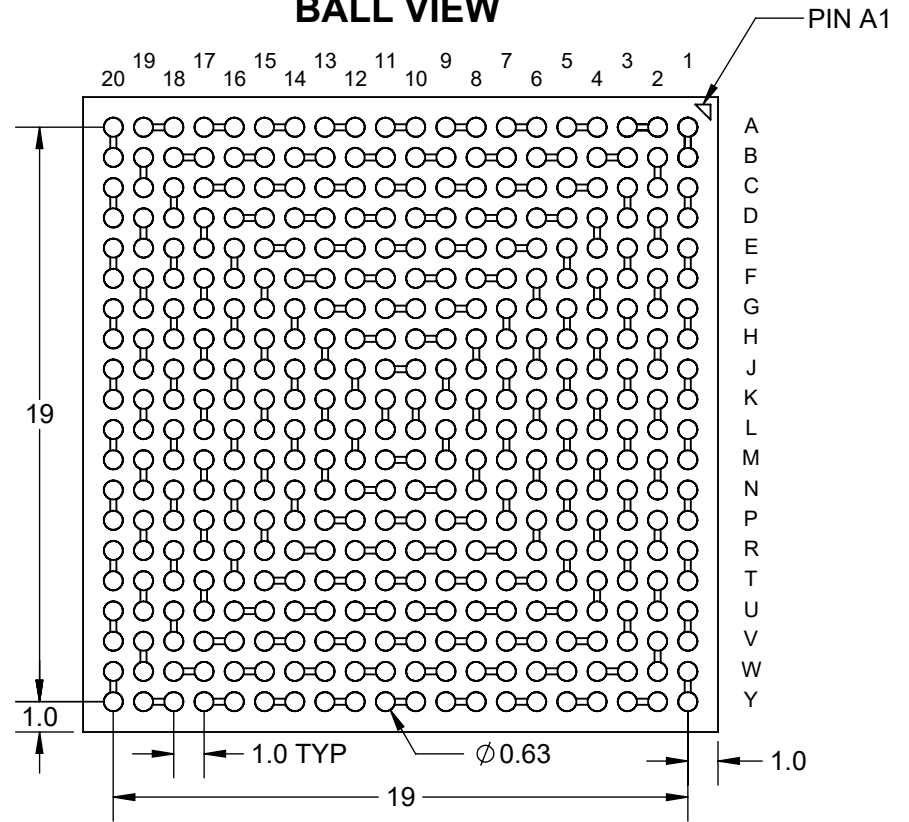

SECTION A-A
SCALE 4 : 1

Notes: (Unless Otherwise Specified).

- 1) ALL DIMENSIONS:mm
- 2) SOLDER BALL ALLOY: SEE PART NUMBER TABLE
- 3) BALL DIAMETER (BEFORE REFLOW): $\phi 0.63$ mm (25mil)
- 4) SOLDER MASK DEFINED PAD OPENING: $\phi 0.50$ mm (20mil)
- 5) PAD Cu DIAMETER: $\phi 0.63$ mm (25mil)
- 6) SUBSTRATE MATERIAL: BT (ALTERNATE FR4)
- 7) DUMMY DIE IS OPTIONAL
- 8) DAISY CHAIN ATTERN (SEE PAGE 2)
- 9) MSL-3 RECOMMENDED BAKING 24 HOURS @ 125°C TO REMOVE MOISTURE PRIOR TO SOLDERING TO PC BOARD

PART NUMBER TABLE

PART NUMBER	BALL ALLOY	BALL CODE	RoHS	Si DIE
LPGA400T1.0C-DC209D	Sn96.5/Ag3.0/Cu0.5	SAC305	YES	YES
LPGA400T1.0-DC209D	Sn63/Pb37	Sn63	NO	YES

APPROVALS	DATE				
DRAWN T. Au	4/9/2026				
ENG M. Hart	4/9/2026	TITLE LPGA400T1.0C-DC209D DAISY CHAIN DUMMY			
MFG		SCALE 5:1	SIZE A	DRAWING NO. 512091	REV A
QA		DO NOT SCALE DRAWING			SHEET 1 OF 3
CUST					
REVISED					

BALL VIEW

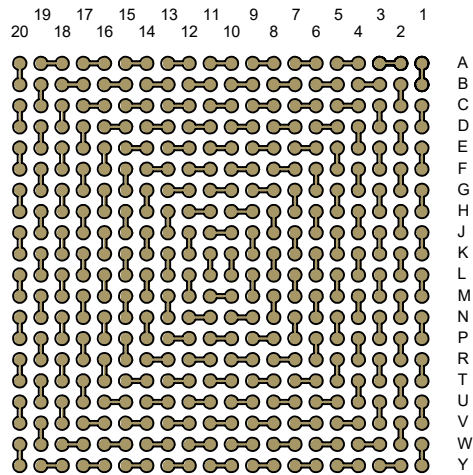

BOTTOM SIDE (TOP X-RAY VIEW)

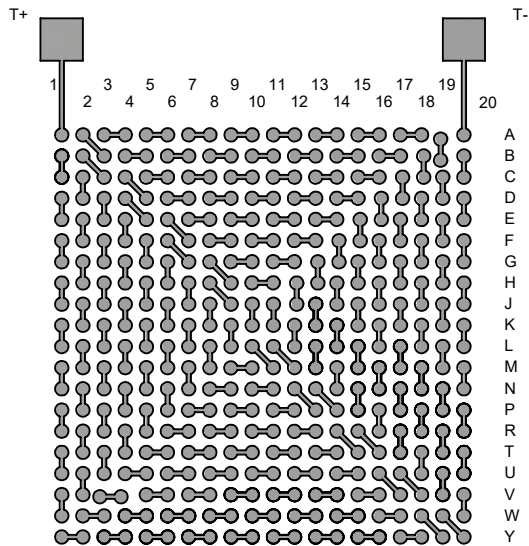
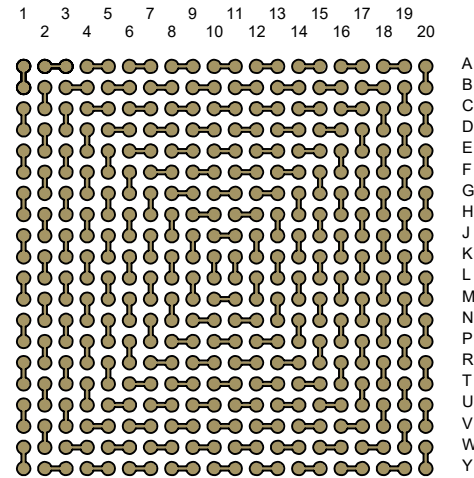

TEST VEHICLE BOARD

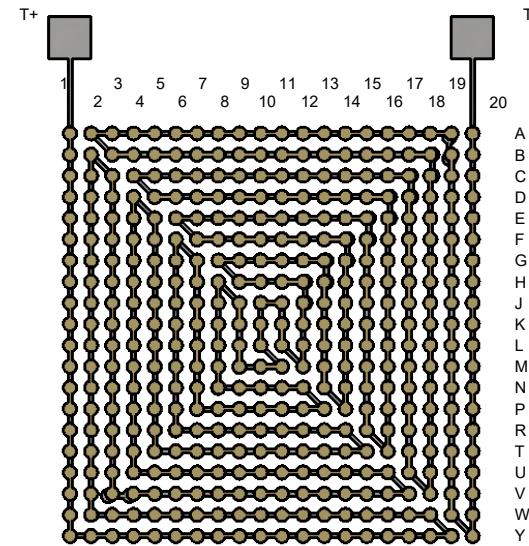

AFTER MOUNTING

Notes:

- 1) PCB BOARD DIMENSIONS ARE PRESENTED ONLY AS A GUIDELINE.
DESIGNERS SHOULD USE THEIR OWN EXPERIENCE WHEN DESIGNING PCB.
- 2) PCB Cu BALL PAD DIAMETER ϕ 0.50mm (19.7mil).
- 3) PCB DAISY CHAIN TRACING LINE WIDTH 0.150 [6mil].
- 4) SMD (SOLDER MASK DEFINED) PAD OPENING ϕ 0.406mm (16mil).

TopLine®

TITLE LPGA400T1.0C-DC209D
DAISY CHAIN DUMMY

SCALE 3.5:1	SIZE A	DRAWING NO. 512091	REV A
----------------	-----------	-----------------------	----------

DO NOT SCALE DRAWING

SHEET 2 OF 3

MODEL

TOP

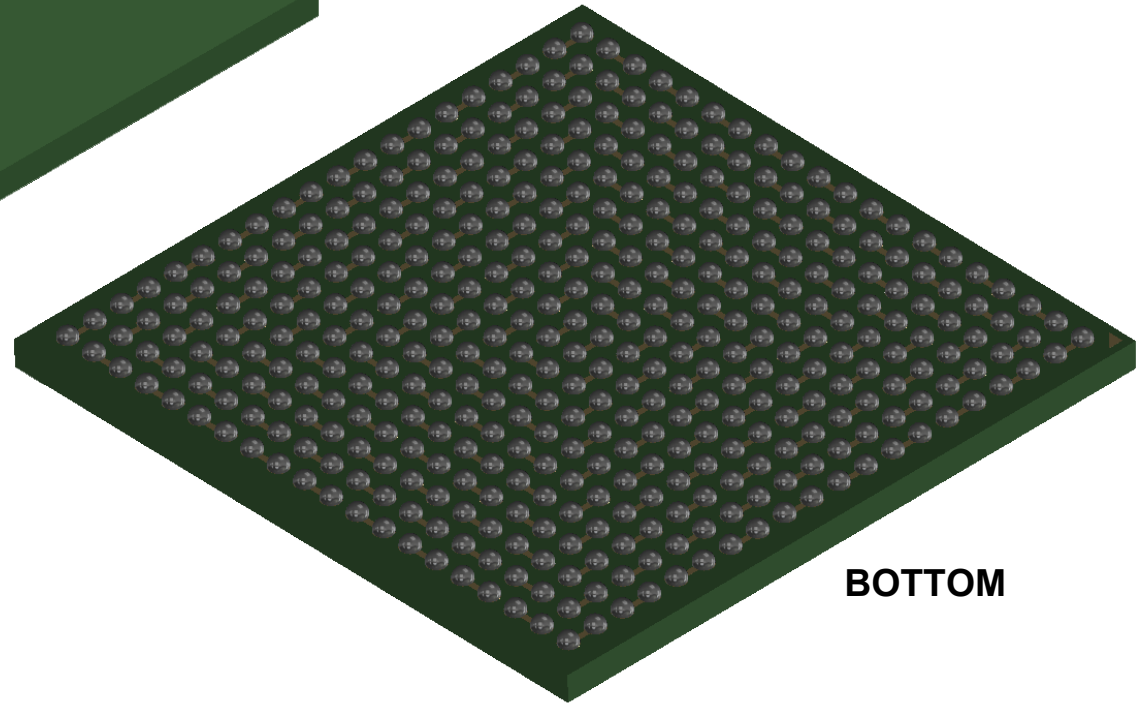
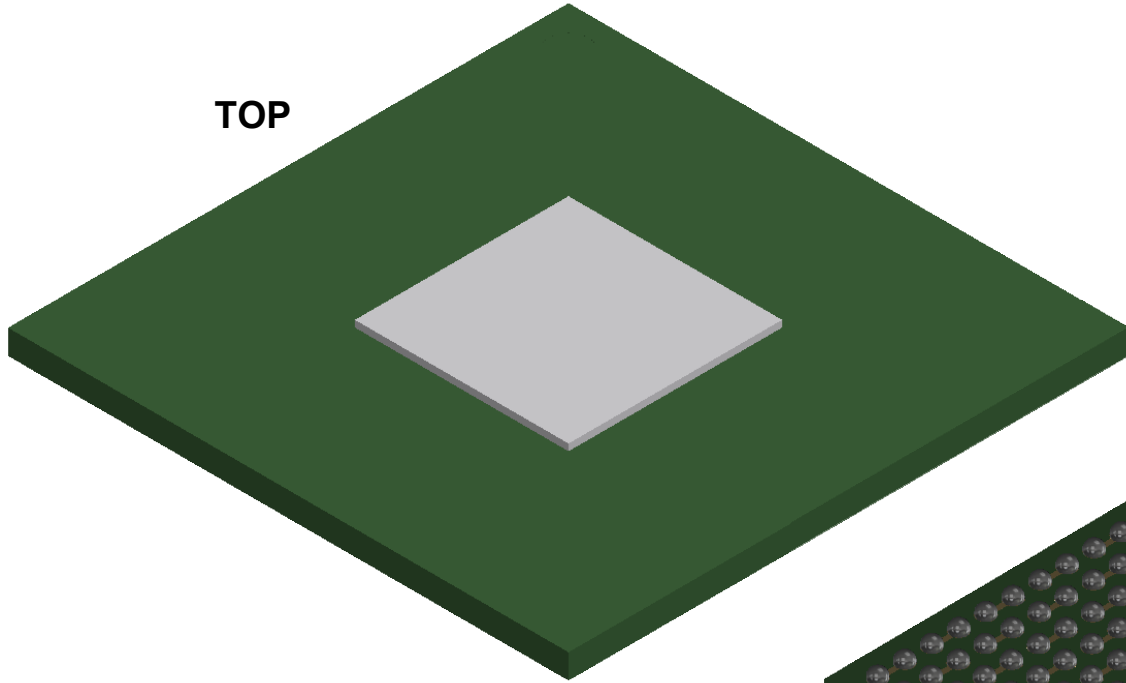

BOTTOM

TopLine[®]

TITLE LBGA400T1.0C-DC209D
DAISY CHAIN DUMMY

SCALE 6:1	SIZE A	DRAWING NO. 512091	REV A
--------------	-----------	-----------------------	----------

DO NOT SCALE DRAWING

SHEET 3 OF 3