

Part # **SOP20**

Leads **20** Pitch **1.27mm (.05")**

Body Size **208mil (5.3mm)**



Tel 1-714-898-3830

info@topline.tv

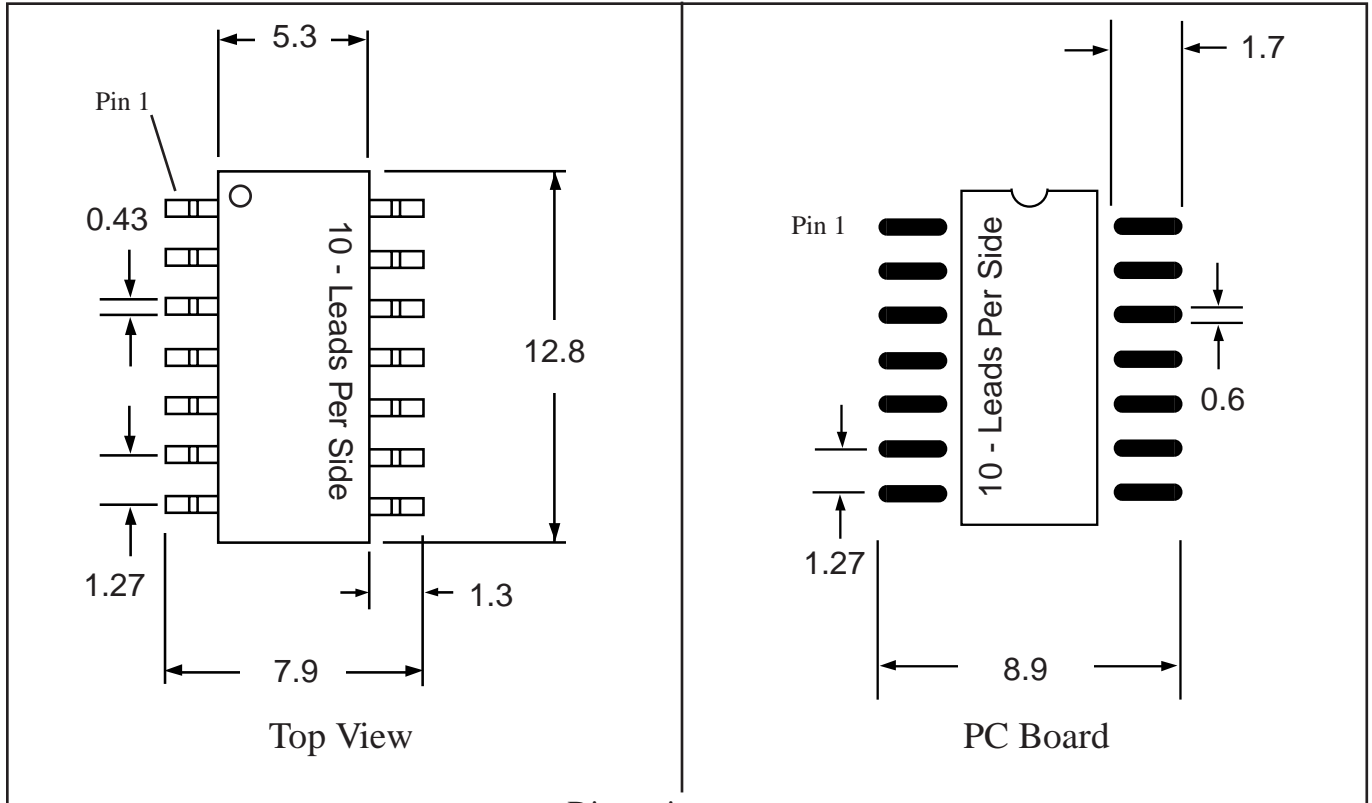

Dimensions = mm

