

### BOTTOM VIEW

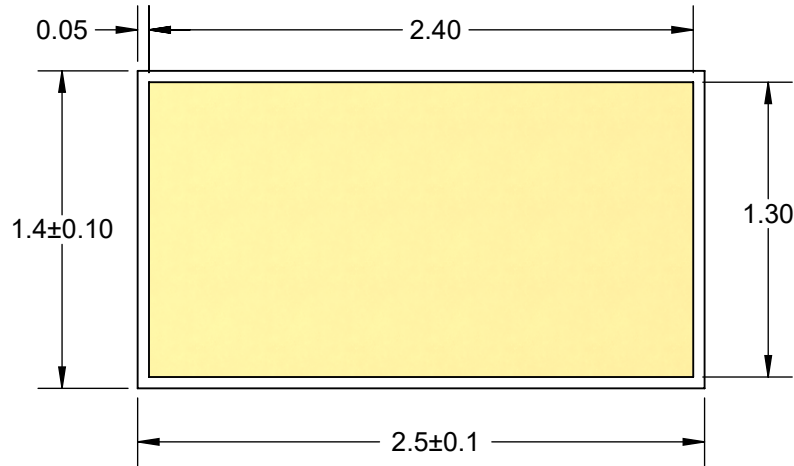

### RECOMMENDED PCB PATTERN

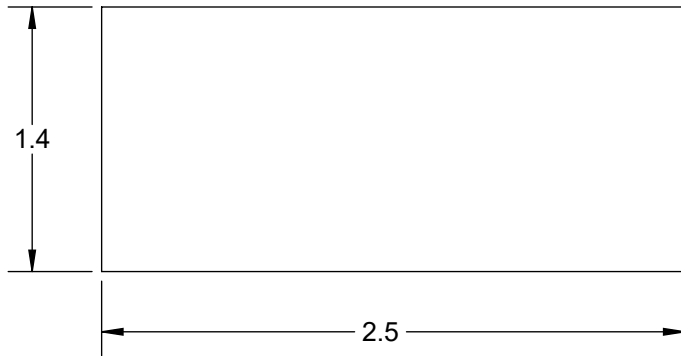

PCB DIMENSIONS ARE PRESENTED ONLY AS A GUIDELINE. DESIGNERS SHOULD USE THEIR OWN KNOWLEDGE BASE WHEN DESIGNING THE PCB.

### PAD DETAIL A

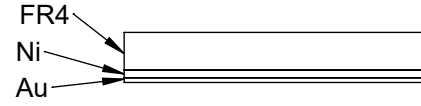

METALLIZATION THICKNESS	
Ni	4.0±1.5µm
Au	0.05±0.02µm

### SIDE VIEW

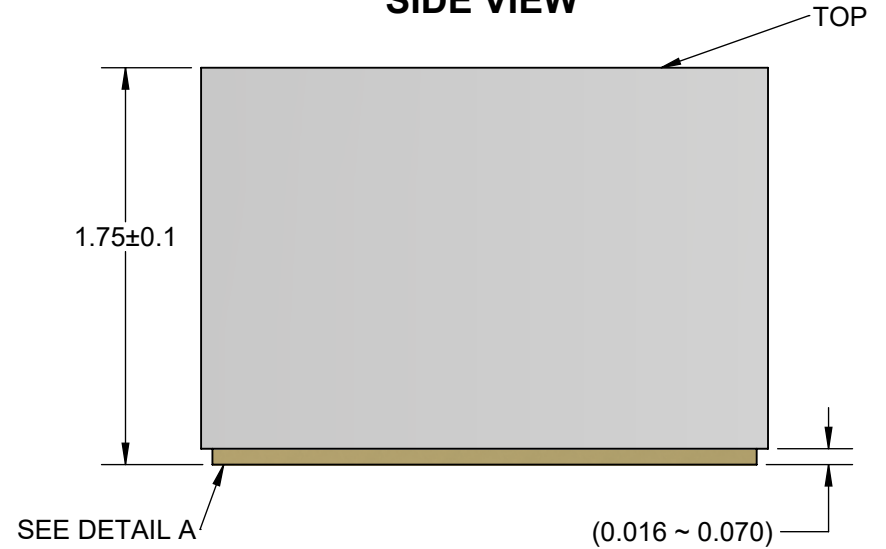

### NOTES:

1. DIMENSION IN mm EXCEPT AS NOTED.
2. TERMINATION: NiAu.
3. Pb-FREE AND HALOGEN FREE.

### MODEL

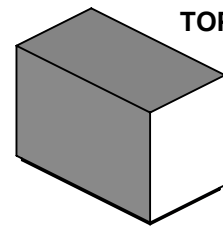

TOP

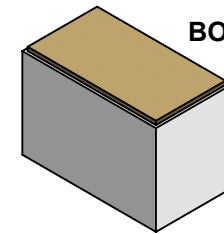

BOTTOM TERMINALS

APPROVALS	DATE	<b>TopLine®</b>			
DRAWN T.Au	4/15/2023				
ENG M. Hart	4/15/2023	TITLE SSL100569 - 1.75mm H SINGLE BOTTOM TERMINAL SPACER			
MFG		SCALE	SIZE	DRAWING NO.	REV
QA		50:1	A	100569	A
CUST		DO NOT SCALE DRAWING			SHEET 1 OF 2
REVISED					

# W12P4 CARRIER TAPE DIMENSION

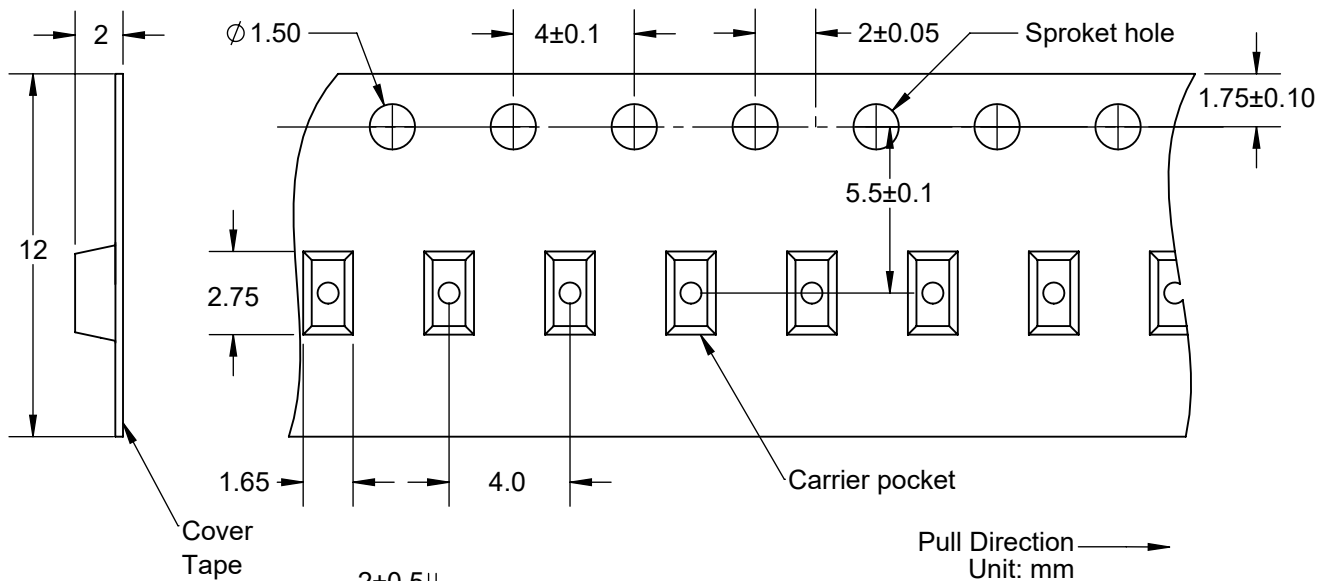

# PART NUMBER SYSTEM

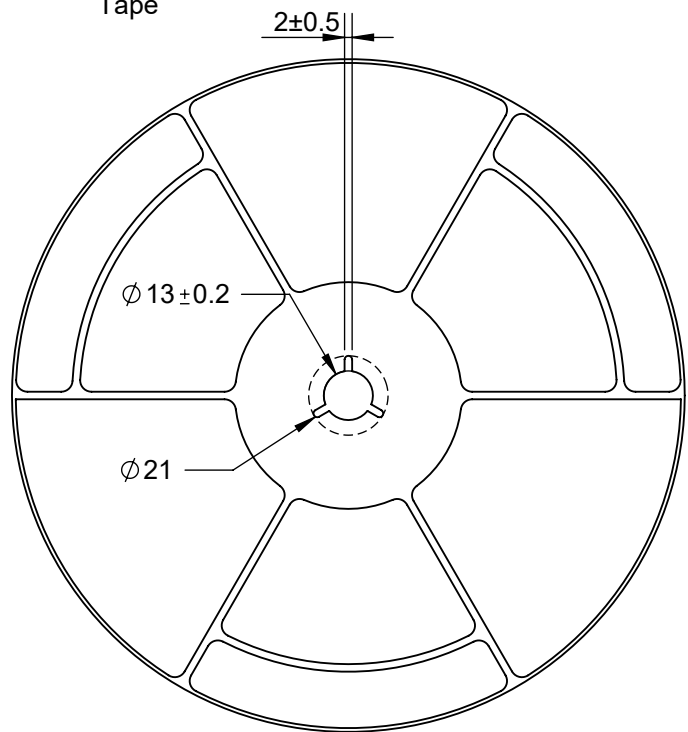
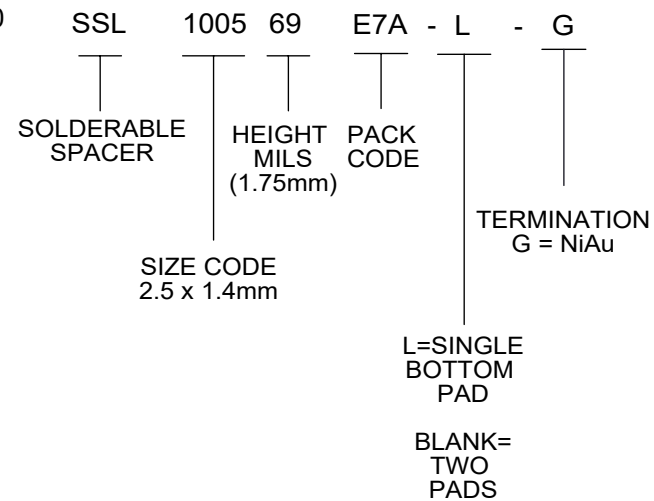

# REEL DIMENSIONS

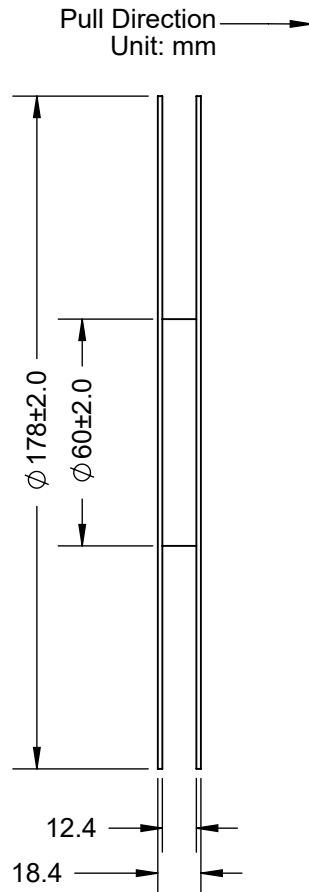

PACK CODE		
CODE	QTY	REEL
E7A	1,000	Ø 178mm

NOTE: PLACE COMPONENT IN TAPE PAD SIDE DOWN

<b>TopLine®</b>			
TITLE SSL100569 - 1.75mm H SINGLE BOTTOM TERMINAL SPACER			
SCALE NONE	SIZE A	DRAWING NO. 100569	REV A
DO NOT SCALE DRAWING			SHEET 2 OF 2