

SIDE VIEW

TOP VIEW

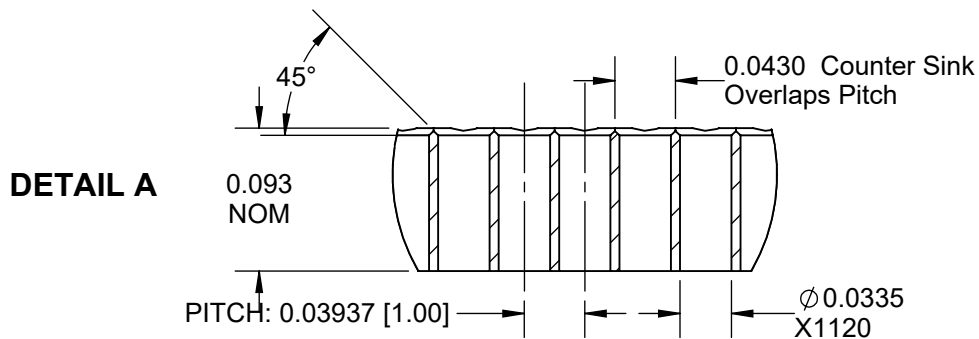
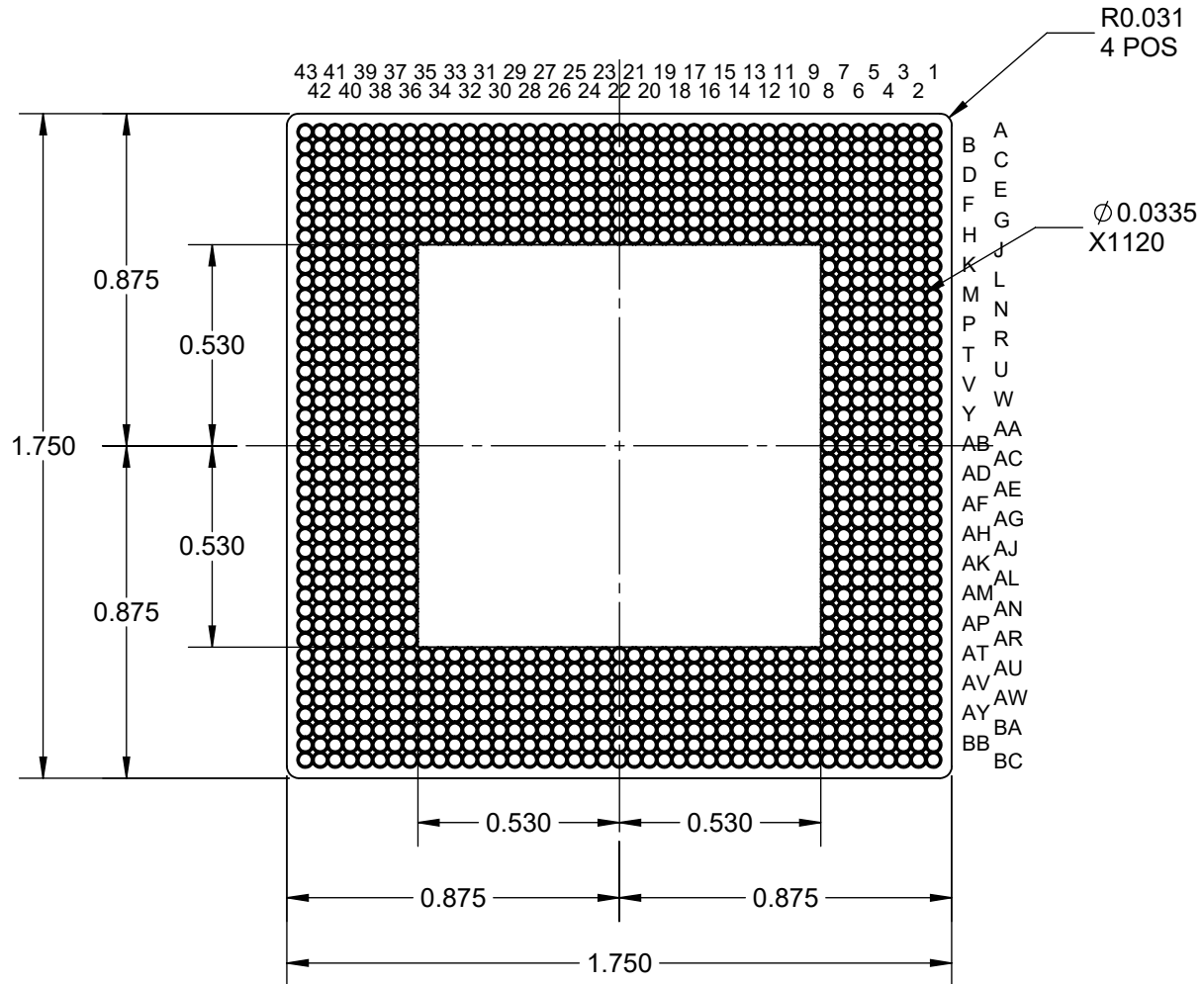
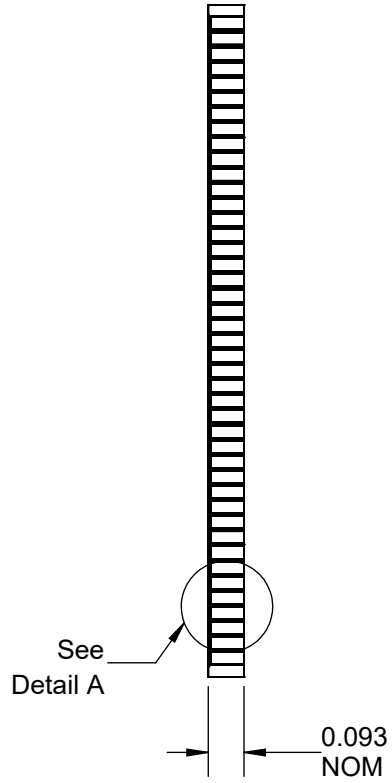

NOTES:

1. DIMENSIONS IN INCH UNLESS OTHERWISE STATED.
2. MATERIAL: PC-300 ESD POLYCARBONATE
3. THICKNESS 0.093 NOM.

APPROVALS	DATE	TopLine®			
DRAWN T. Au	10/27/2019				
ENG M. Hart	10/27/2019	TITLE CCGA1849 TRAY ADAPTER 45mm x 45mm			
MFG		SCALE 2:1	SIZE A	DRAWING NO. 021437	REV A
QA					
CUST		DO NOT SCALE DRAWING			SHEET 1 OF 5
REVISED					

EXPLODED VIEW

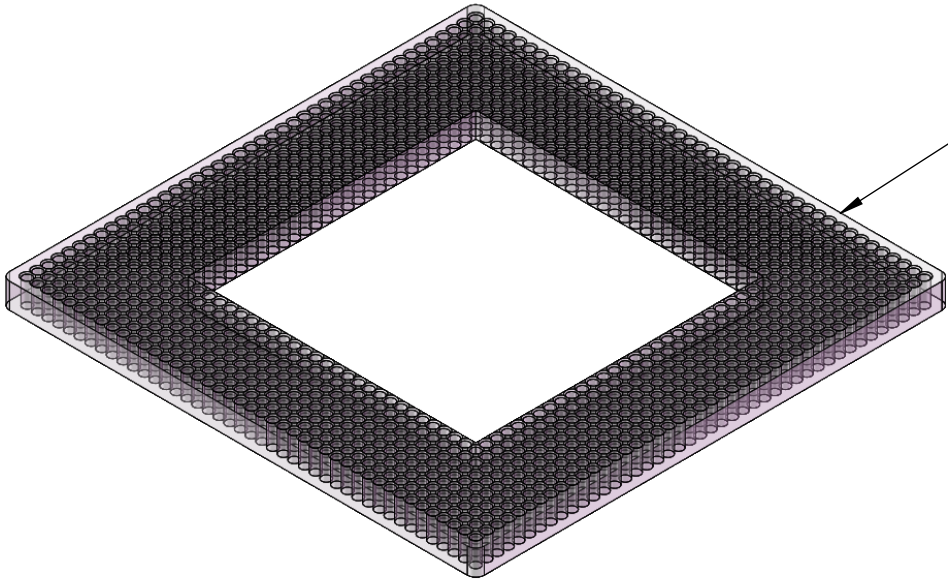

**DWG 021437
ADAPTOR**

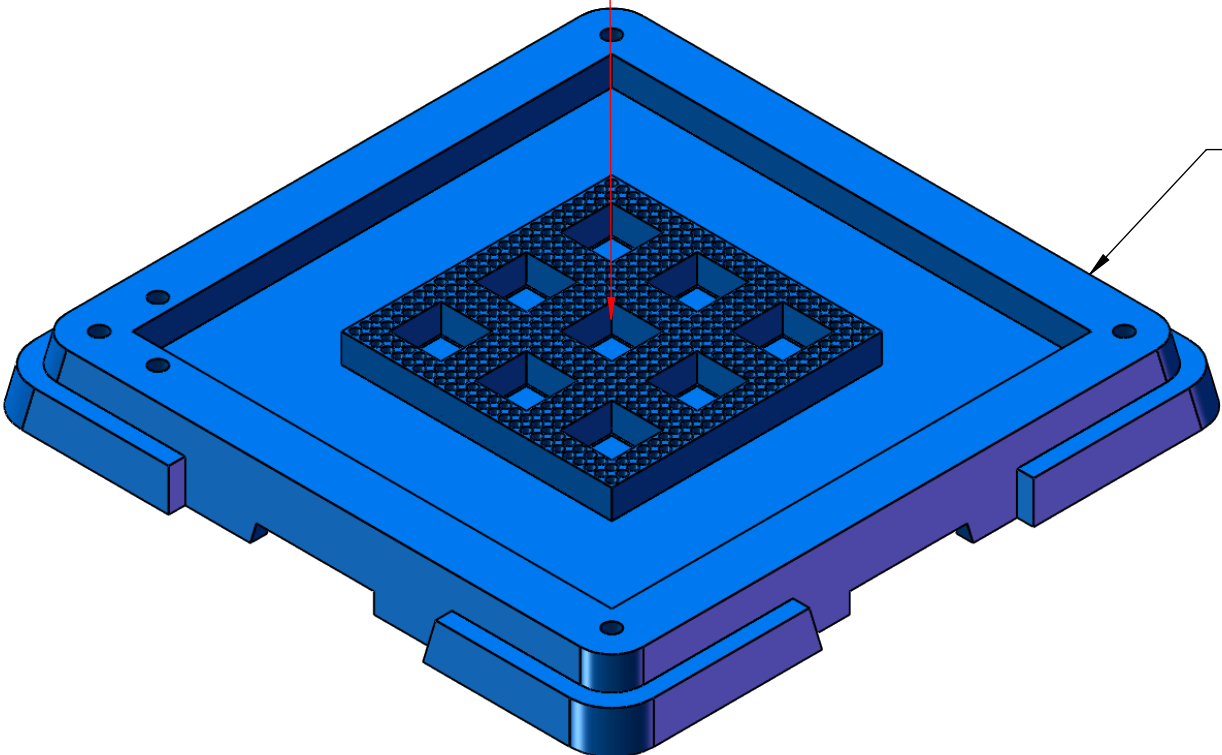

**DWG 031000
BLUE CCGA**

TopLine®

TITLE CCGA1849 TRAY ADAPTER
45mm x 45mm

SCALE 2:1	SIZE A	DRAWING NO. 021437	REV A
--------------	-----------	-----------------------	----------

DO NOT SCALE DRAWING SHEET 3 OF 5

MODEL ASSEMBLY

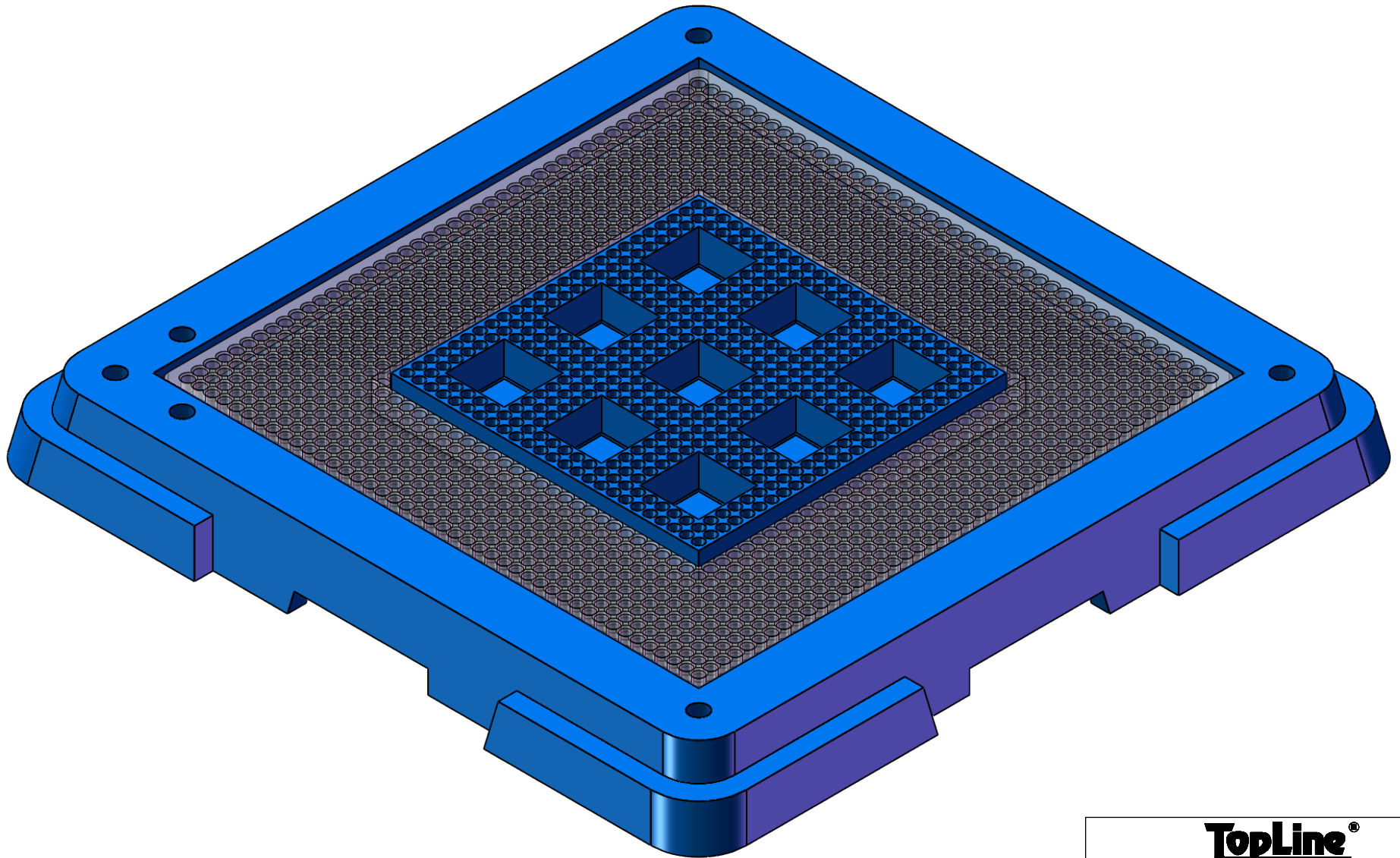

TopLine[®]

TITLE CCGA1849 TRAY ADAPTER
45mm x 45mm

SCALE	SIZE	DRAWING NO.	REV
3:1	A	021437	A

DO NOT SCALE DRAWING

SHEET 4 OF 5

MODEL TOP

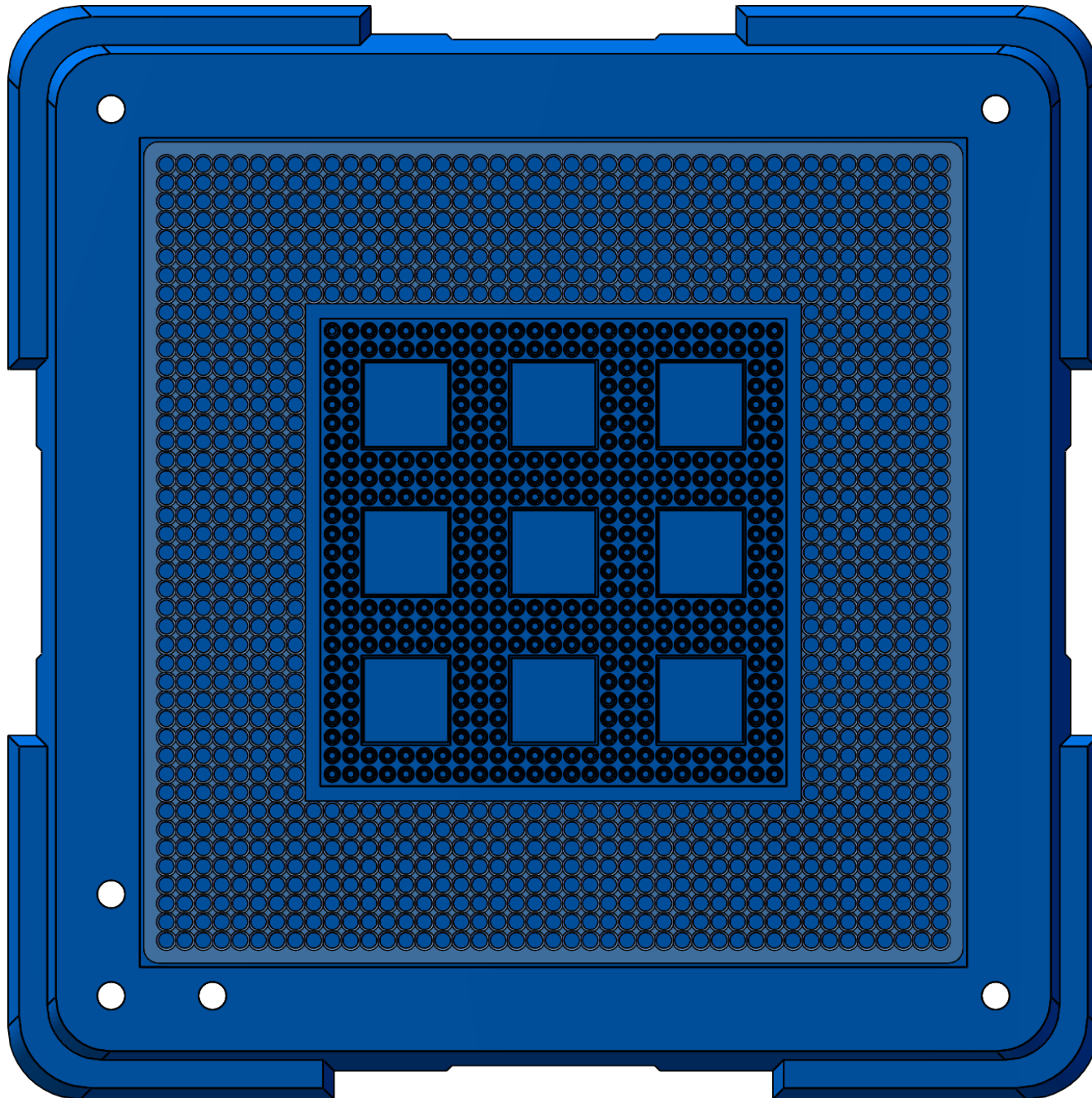

TopLine[®]

TITLE CCGA1849 TRAY ADAPTER
45mm x 45mm

SCALE	SIZE	DRAWING NO.	REV
3:1	A	021437	A

DO NOT SCALE DRAWING

SHEET 5 OF 5